



RAZER SEIREN V3 PRO

MASTER GUIDE

CONTENTS

| | |
|---|----|
| 1. WHAT'S INSIDE | 2 |
| 2. WHAT'S NEEDED | 5 |
| 3. LET'S GET YOU COVERED | 5 |
| 4. SETTING UP YOUR MICROPHONE | 6 |
| 5. USING YOUR MICROPHONE | 8 |
| 6. CONFIGURING YOUR RAZER SEIREN V3 PRO | 10 |
| 7. SAFETY AND MAINTENANCE | 25 |
| 8. LEGALESE..... | 26 |

1. WHAT'S INSIDE

- Razer Seiren V3 Pro

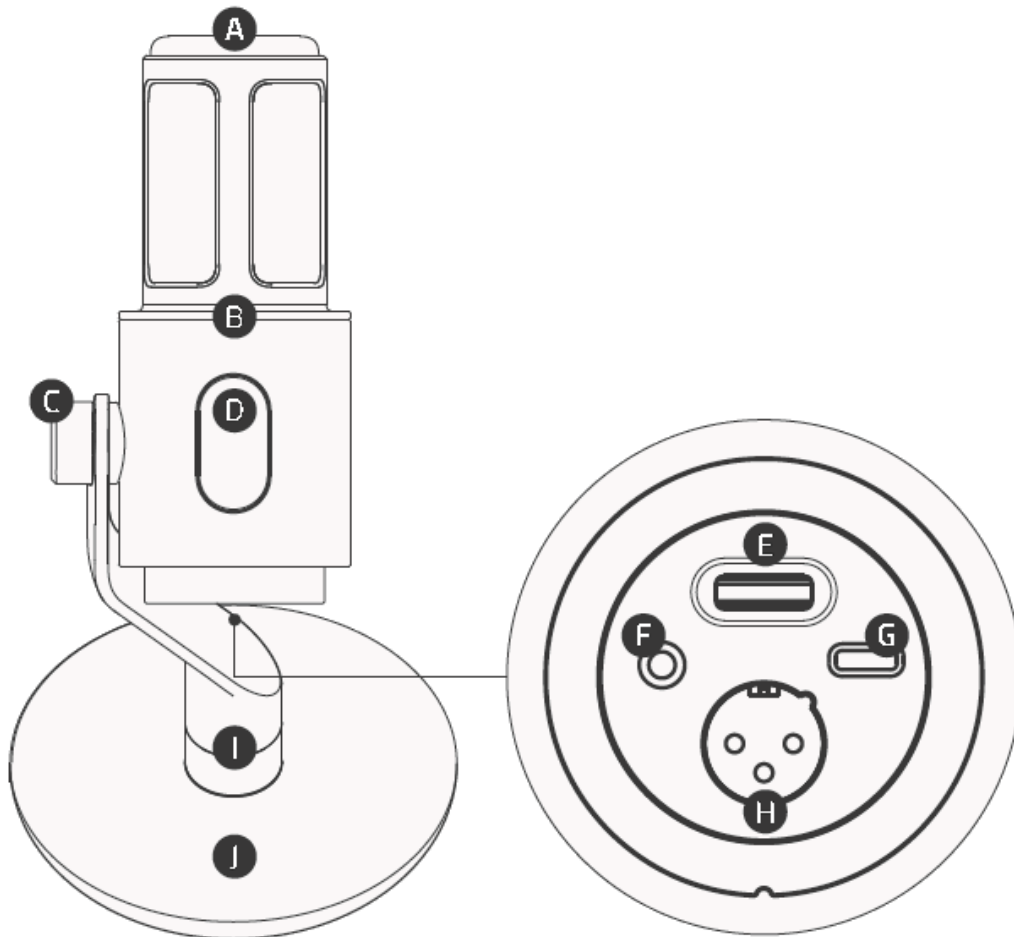

- A. Cardioid dynamic mic
- B. Light Ring powered by Razer™ Chroma RGB
- C. Adjustable arm mount
- D. Touch mute button
- E. Mic gain/volume control
- F. 3.5 mm headphone monitoring jack
- G. USB Type C port
- H. Three-pin XLR (XLR3) jack
- I. Swivel knob
- J. Removable desktop stand

- USB Type A to Type C cable

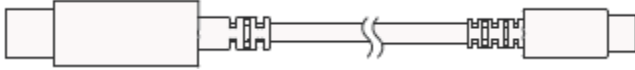

- USB Type A to Type C adapter

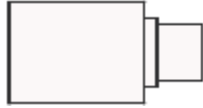

- Removable pop filter



- Important Product Information Guide

2. WHAT'S NEEDED

PRODUCT REQUIREMENTS

- PC or mixer with USB Type C/Type A or XLR input

RAZER SYNAPSE REQUIREMENTS

- Windows® 11 (or higher)
- Internet connection for software installation

i *Other compatible software includes Audacity, OBS, Streamlabs OBS, and XSplit (software license fee may apply).*

3. LET'S GET YOU COVERED

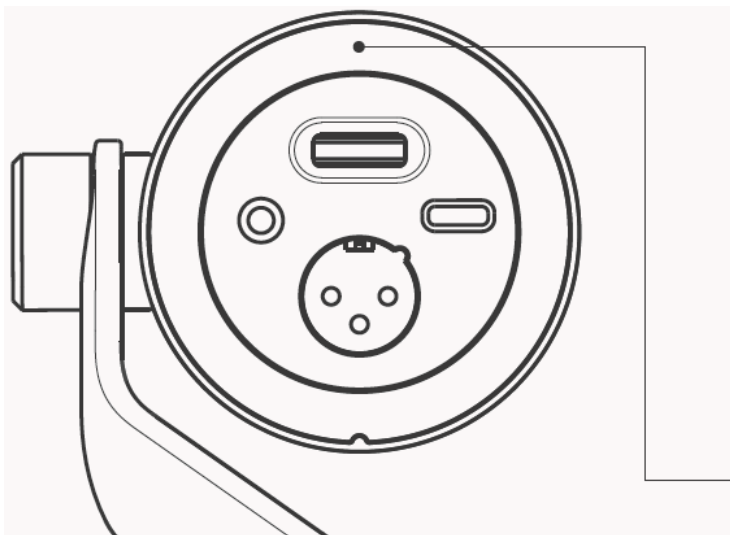

Your product's serial number can be found here.



You've got a great device — now make it even better. Register your device at razerid.razer.com to get covered and unlock exclusive Razer benefits.

i *A valid Proof of Purchase is required for any Limited Warranty Claim.*

4. SETTING UP YOUR MICROPHONE

1.

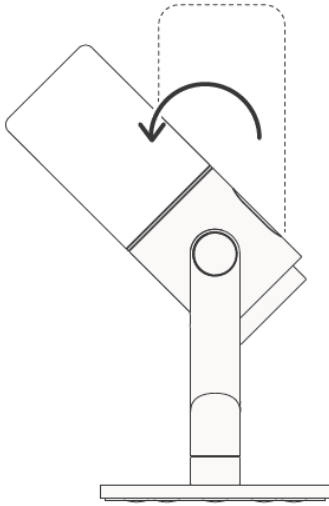

2.

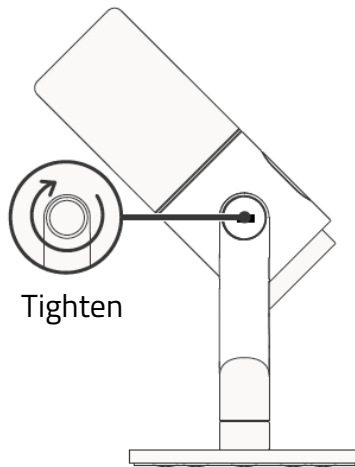
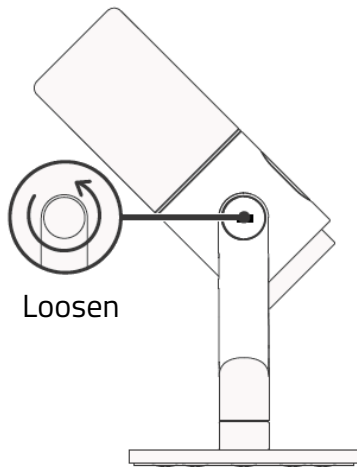

3.

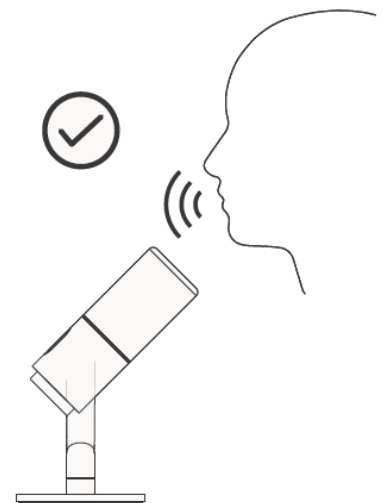
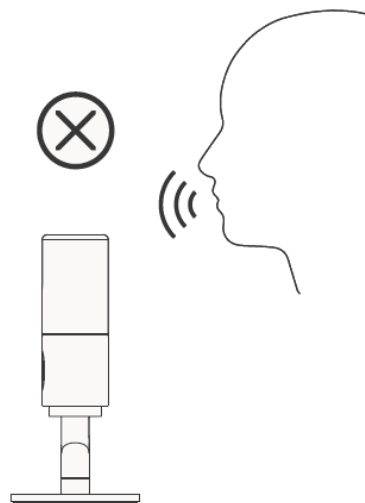
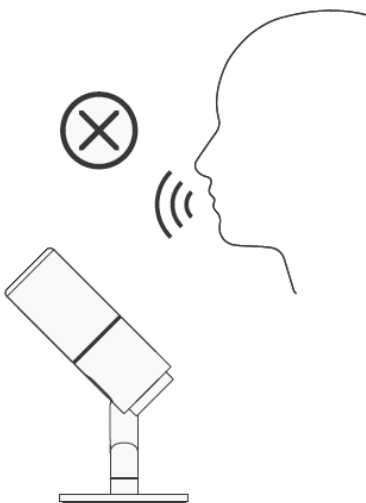

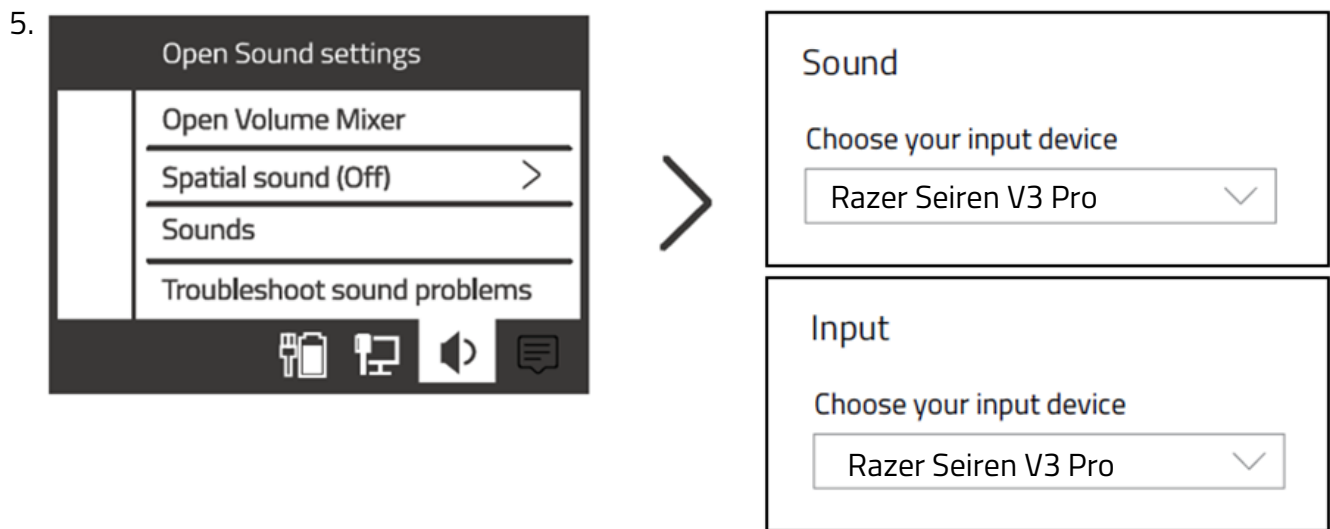
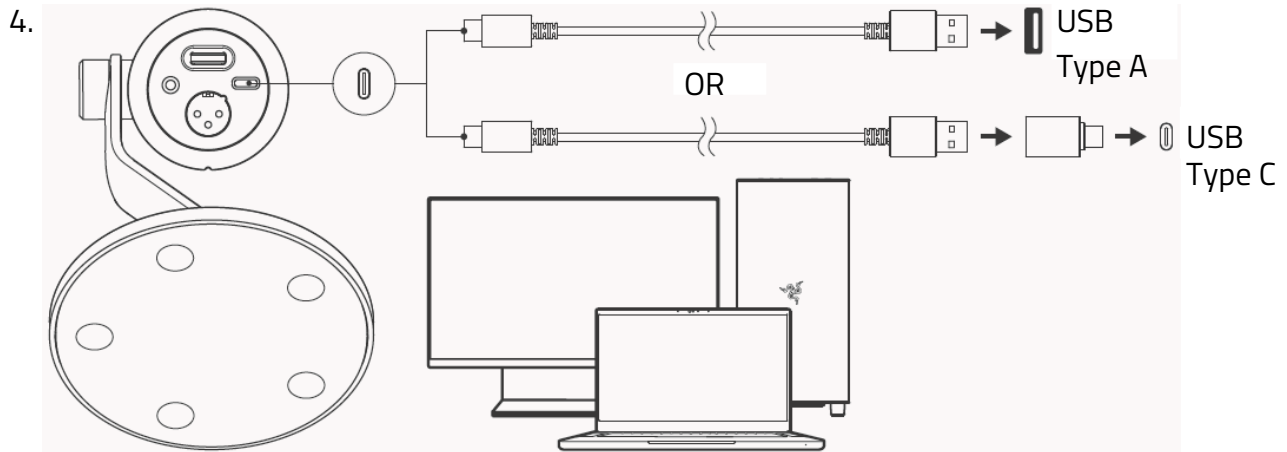
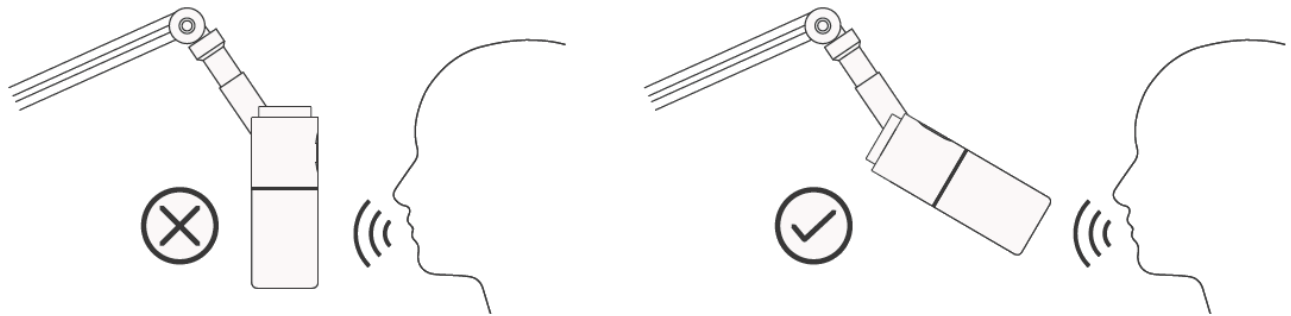

i Install Razer Synapse when prompted or download the installer from [razer.com/synapse](https://www.razer.com/synapse). Unleash the true potential of your product with new features such as Parametric EQ, Vocal Bass, Exciter tools, and more!

5. USING YOUR MICROPHONE

MUTE/UNMUTE THE MICROPHONE INPUT

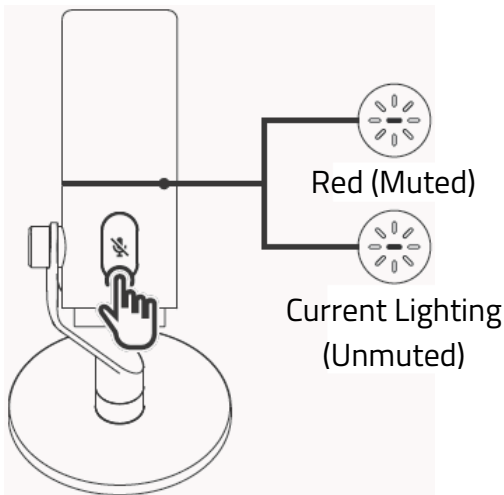

ADJUST THE MICROPHONE GAIN

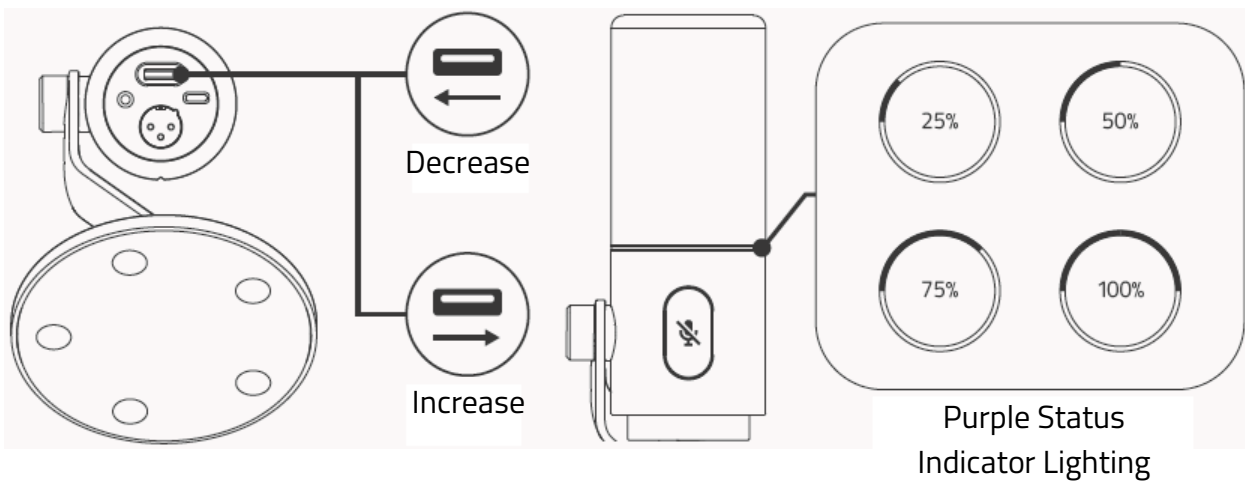

ENABLE HEADPHONE MONITORING

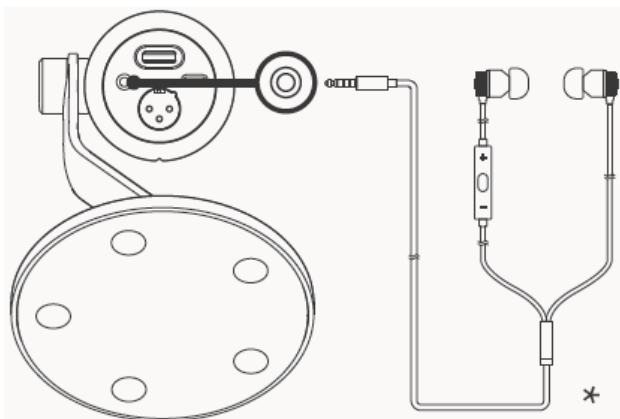

ADJUST THE HEADPHONE MONITORING VOLUME

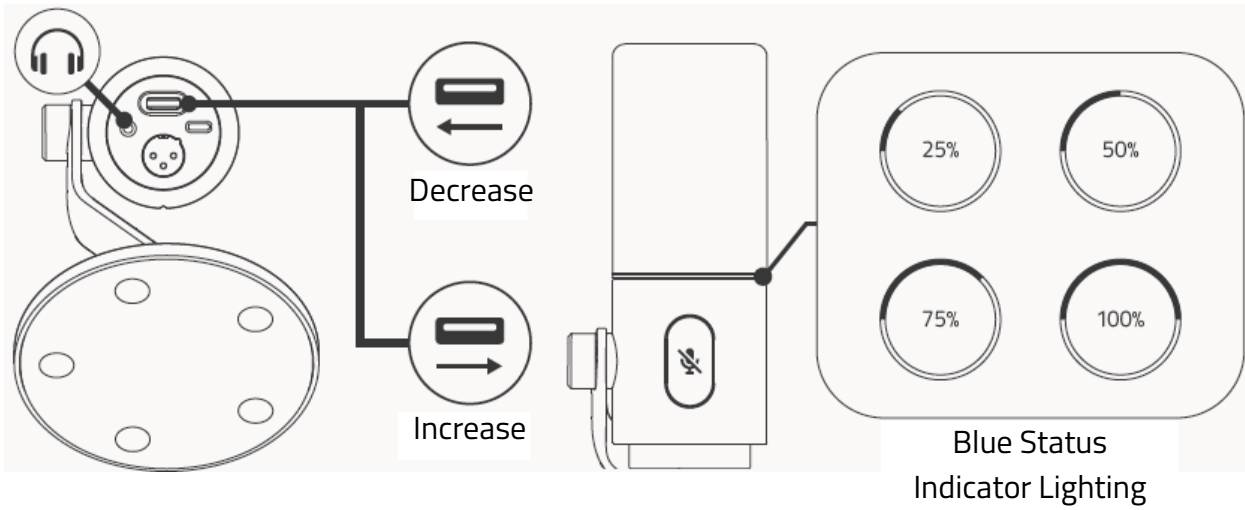

i To adjust the volume using the dial, you must first configure it in Razer Synapse.

CONNECT AN XLR3 CABLE

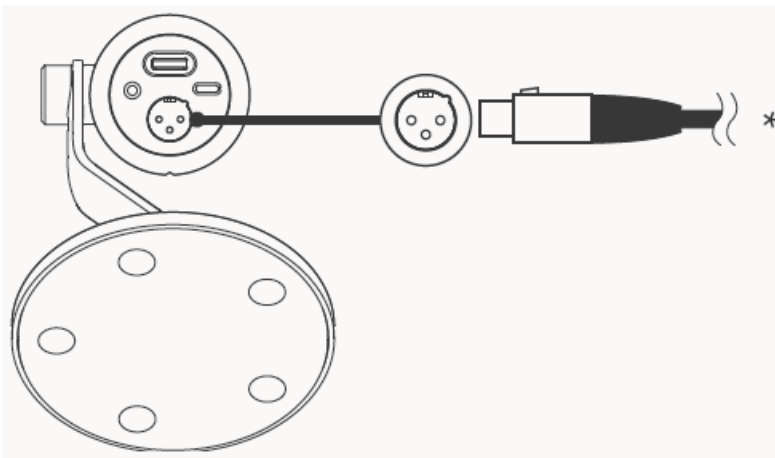

**Not included*

6. CONFIGURING YOUR RAZER SEIREN V3 PRO

i *Disclaimer: This guide provides an overview of the New Razer Synapse app and may only partially cover some of the features of your device. The New Razer Synapse requires an Internet connection to install, update, access, and save cloud-based features. Registering for a Razer ID account is recommended but optional. All features listed here are subject to change based on the current version, connected device(s), and supported add-ons.*

SYNAPSE

The Synapse tab is your default tab when you first launch Razer Synapse. Use the following buttons below to navigate the user interface:

– Minimize

Clicking this button will minimize the app to the taskbar while it runs in the background.

▢ Maximize

This button expands the browser window to fill the entire screen. To restore the window to its original size, click the maximize button again.

× Close

This button will close all relevant tabs and terminate the application completely.

< Previous Tab

Clicking this button will return you to the last tab you have visited.

> Next Tab

Clicking this button will move you to the next page if you've recently used the Previous Tab button.

↻ Refresh Tab

This button reloads the current page. Use this if a page isn't displaying correctly or you want to see the latest content.

⬇ Download Update

If this button appears, that means there are changes to the app. Use this if a page isn't displaying correctly or you want to see the latest content.

More

Clicking this button will open a pop-up so you can easily access your Devices, Modules, and Other Installed Apps tabs.

Settings

Clicking this button will open the Settings tab, so you can quickly change the settings to this app.

Profile

This button will open a pop-up to access the Log In, Feedback, Rate This Software, Add WiFi Device, and Exit options.

Info

Hovering over this button will pop up an additional information about a feature or function.

Dashboard

The Dashboard subtab is an overview of your Razer Synapse, where you can access all your Razer devices, modules, and online services.

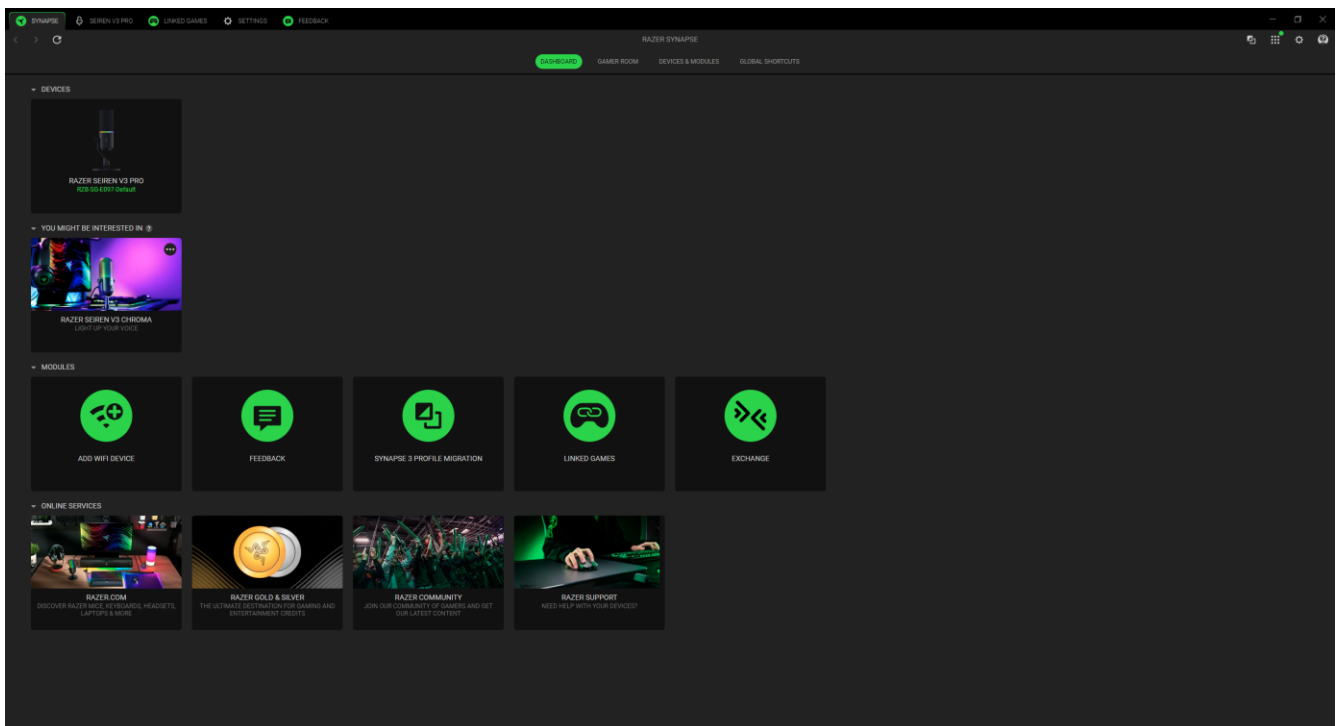

Gamer Room

The Gamer Room subtab shows all devices with the Razer Aether Light feature. From here, you can view and manage your Gamer Room-supported devices.

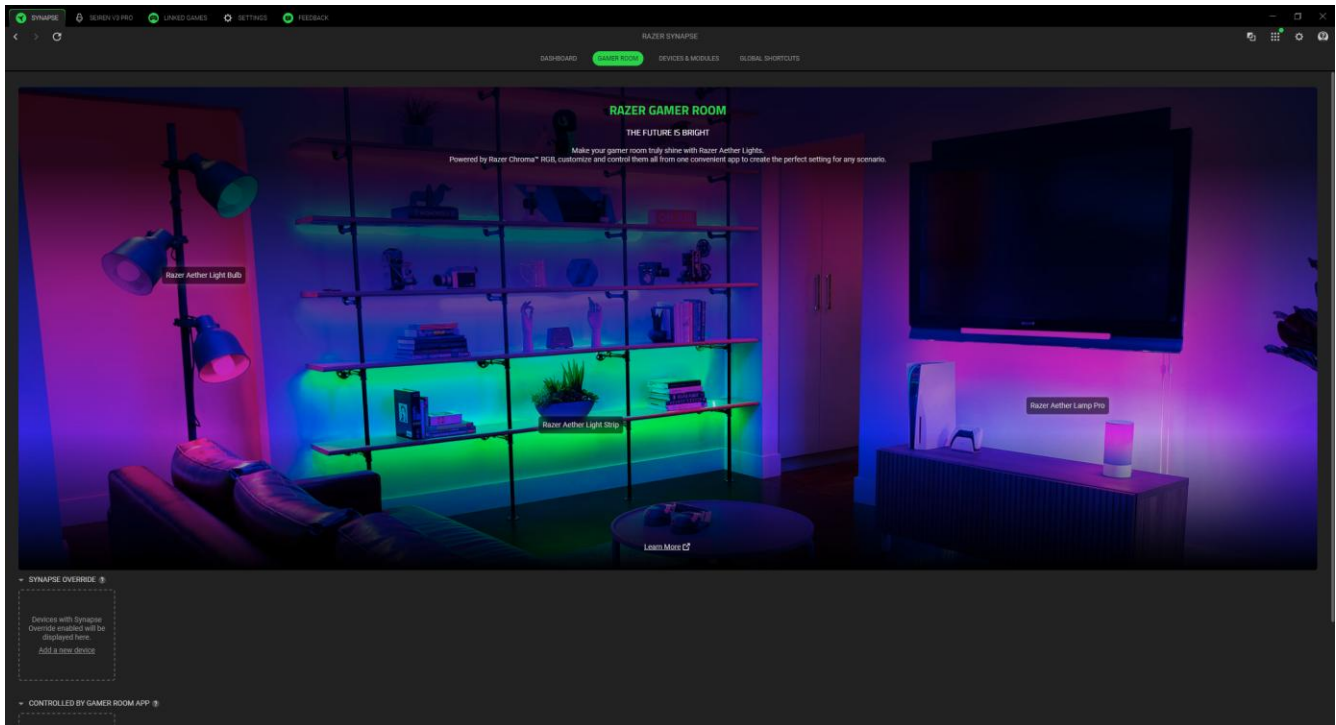

Synapse Override

This section allows you to select and customize your device's lighting and make it react to Chroma-enabled games and Chroma Connect apps using Razer Synapse.

Controlled By Gamer Room App

This section displays all supported devices controlled remotely by the Gamer Room app.

Devices & Modules

The Modules subtab displays all installed and available modules for installation.

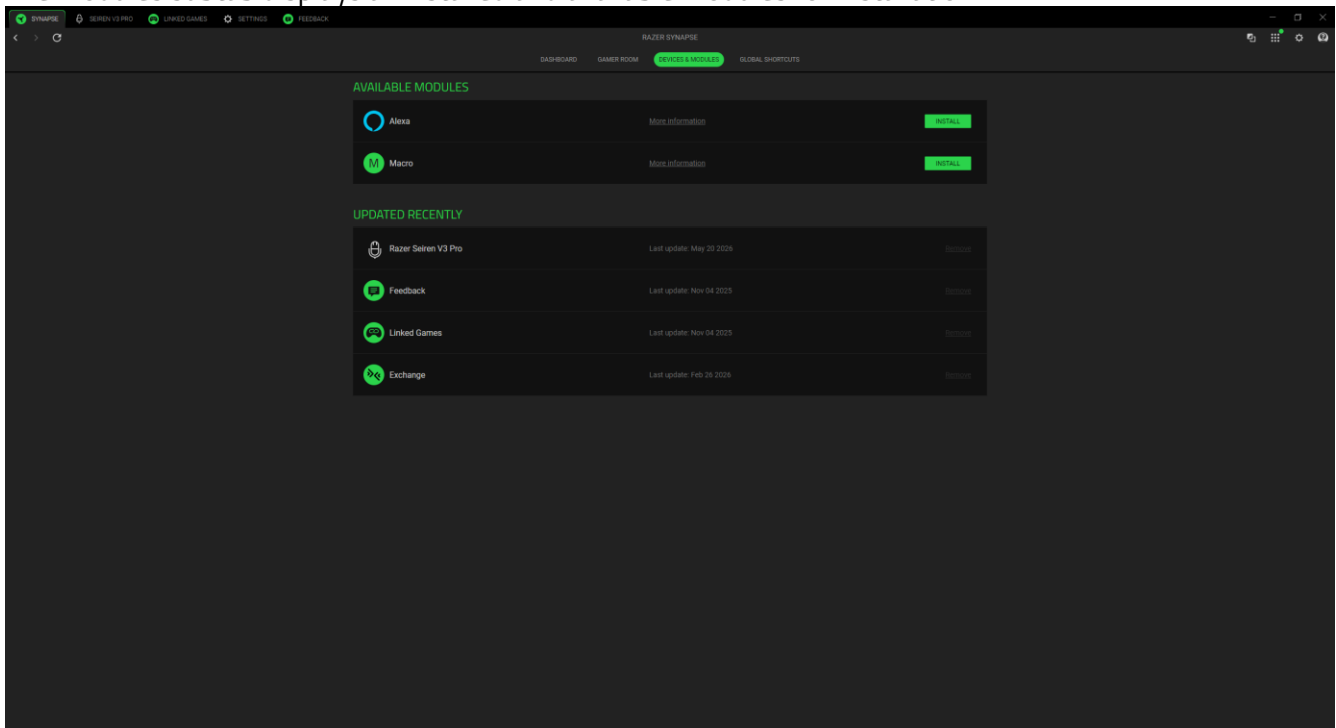

Global Shortcuts

Bind operations or Razer Synapse functions to custom key-combinations from any Razer Synapse-enabled device inputs, which apply across all device profiles.

 *Only Razer Synapse-enabled device inputs will be recognized.*

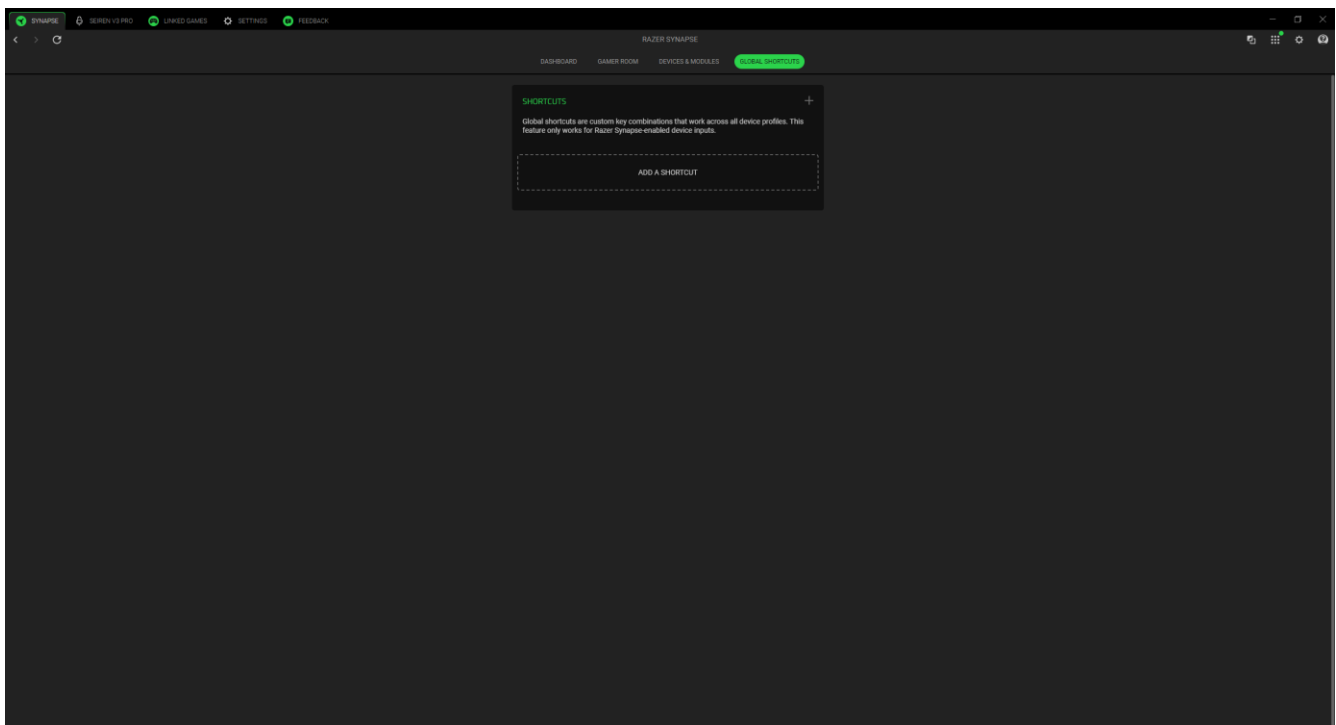

SEIREN V3 PRO

The Seiren V3 Pro tab is the main tab for your Razer device. From here, you'll be able to adjust the microphone gain and headphone volume, enable features such as EQ, effects and stream mixer. Any changes under this tab will be saved automatically to your local system and cloud storage. Use the following buttons below to access your profile options:

▾ Profiles Dropdown Bar

Clicking this dropdown bar will display all the profiles for this device so you can quickly change profiles.

⋮ Miscellaneous

Clicking this button will open a pop-up with options related to your current profile.

EQ

The EQ subtab is for adjusting and modifying your device's microphone settings.

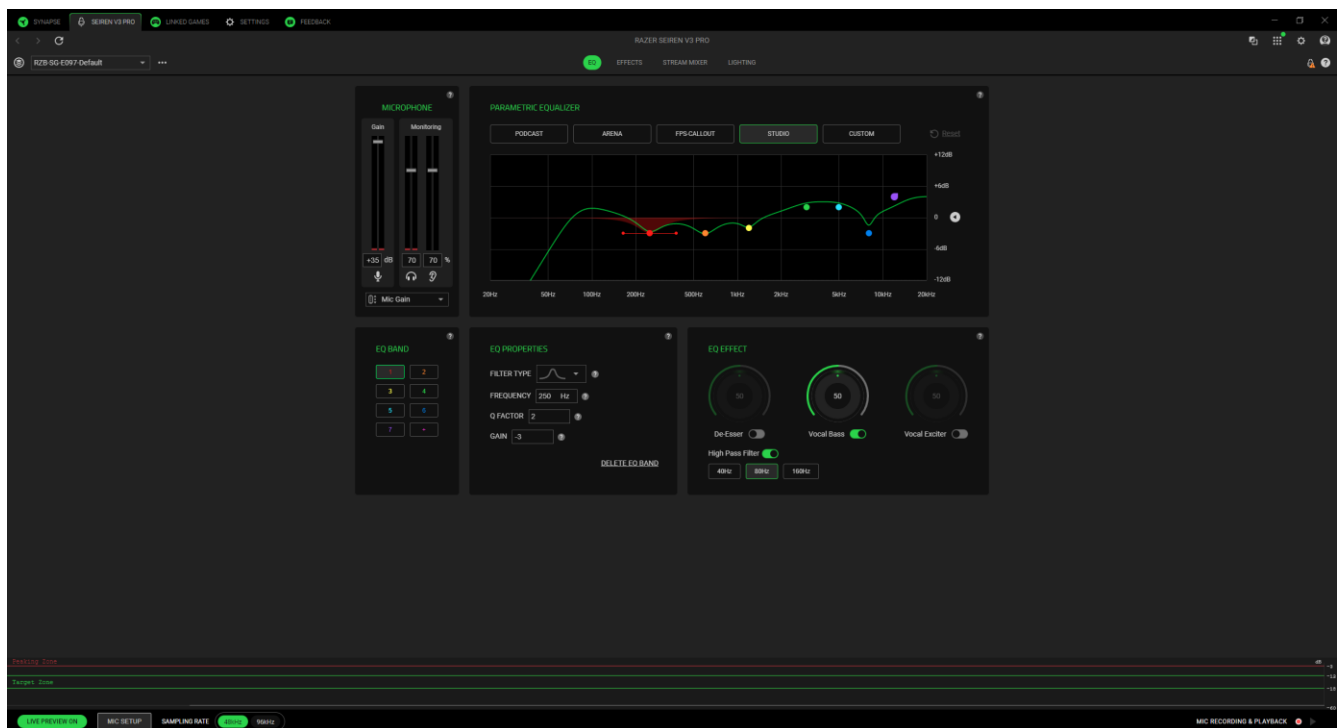

Microphone

The Microphone option is for muting or adjusting the microphone gain and headphone volume.

EQ Band

Select an EQ band to adjust it. The Parametric Equalizer will automatically update based on the band you choose.

Parametric Equalizer

Select any available equalizer preset created for the best audio experience designed for podcasting, game casting, or music production. Manually adjusting any equalizer preset will automatically set it to Custom.

EQ Properties

Change and fine-tune specific frequencies by using filters, adjusting gain, and setting the Q-factor.

EQ Effect

Adjust and apply various EQ effects to improve the overall quality of your audio.

- De-Esser - reduce harsh sibilance in vocal recordings, which helps to prevent sharp "s" and "t" sounds from being overly prominent.
- Vocal Bass - enhance the lower frequencies of the voice, adding warmth and fullness to the sound.
- Voice Exciter - introduce subtle brightness and clarity, making the vocals stand out in the mix.
- High Pass Filter - remove unnecessary low-frequency noise or rumble, which allows the cleaner, clearer elements of the audio to pass through.

Live Preview

Use the live preview to check if your microphone is in the optimal Target Zone for sound quality and monitor the Peaking Zone to avoid distortion (clipping).

Effects

The Effects subtab is for customizing your microphone's input settings.

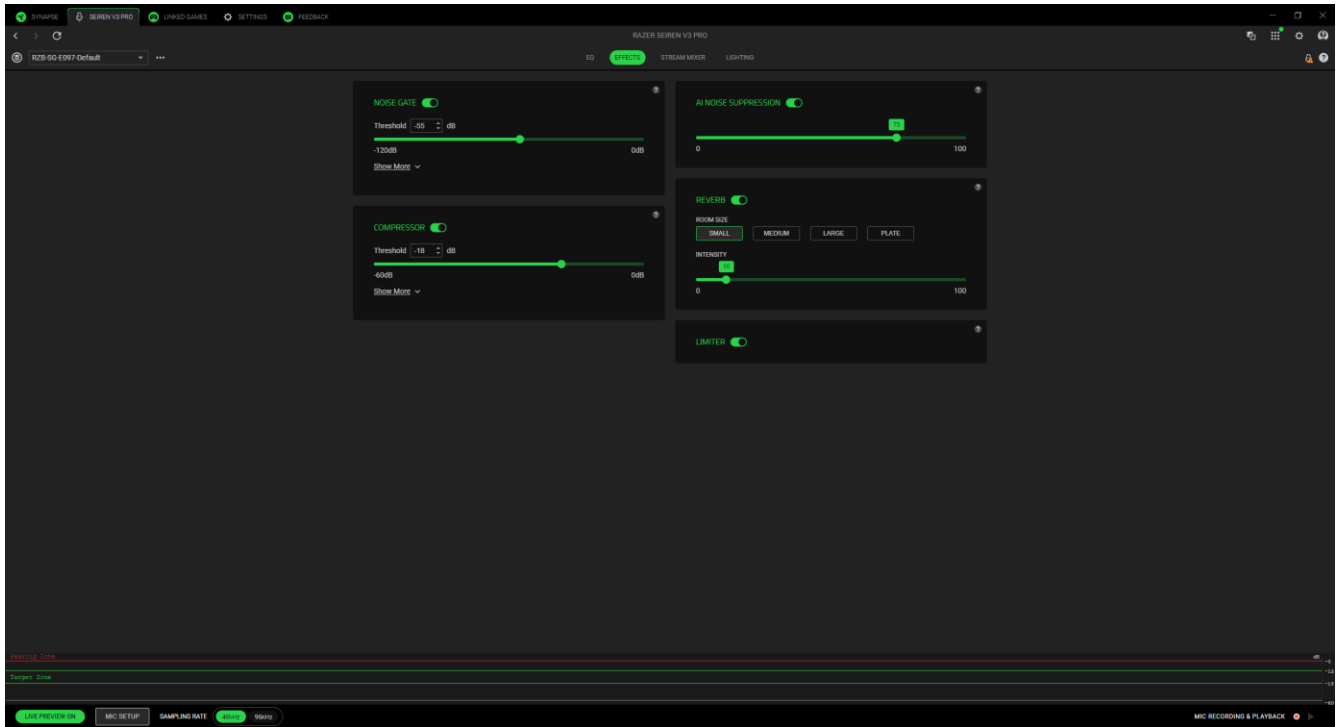

Noise Gate

Adjust the microphone input level to minimize background noise and fully capture your voice.

AI Noise Suppression

Identify and eliminate unwanted background noise using artificial intelligence.

Compressor

Adjust the microphone input to lower its volume when it gets too loud.

Reverb

Select a room size preset to create a sense of space and depth of sound using echo.

Limiter

Reduce the volume and prevent sudden loud peaks that can lead to distortion or clipping.

Stream Mixer

The Stream Mixer subtab enables you to monitor, individually adjust, and mix all available virtual input channels on a single virtual output channel.

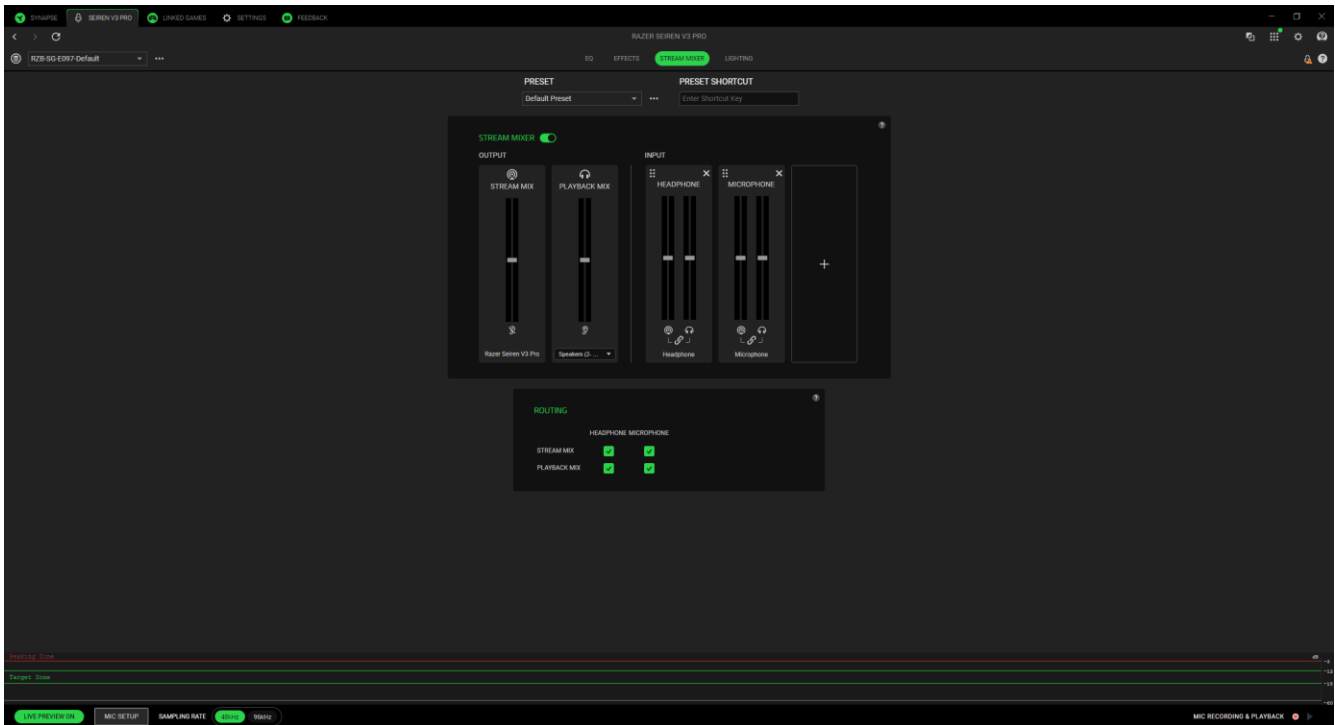

Preset & Preset Shortcut

Use shortcut keys to quickly switch between settings. Make quick adjustments to fit different tasks or preferences with just a simple keystroke.

Stream Mixer

Combine multiple inputs into one output channel. Adjust the gain and volume levels of each input to ensure a clear and balanced output. Add virtual input channels or devices to control your stream easily.

Routing

Manage the audio channels that are heard in the stream and adjust the playback mix for each channel individually.

Lighting

The Lighting subtab enables you to modify your Razer device's light settings.

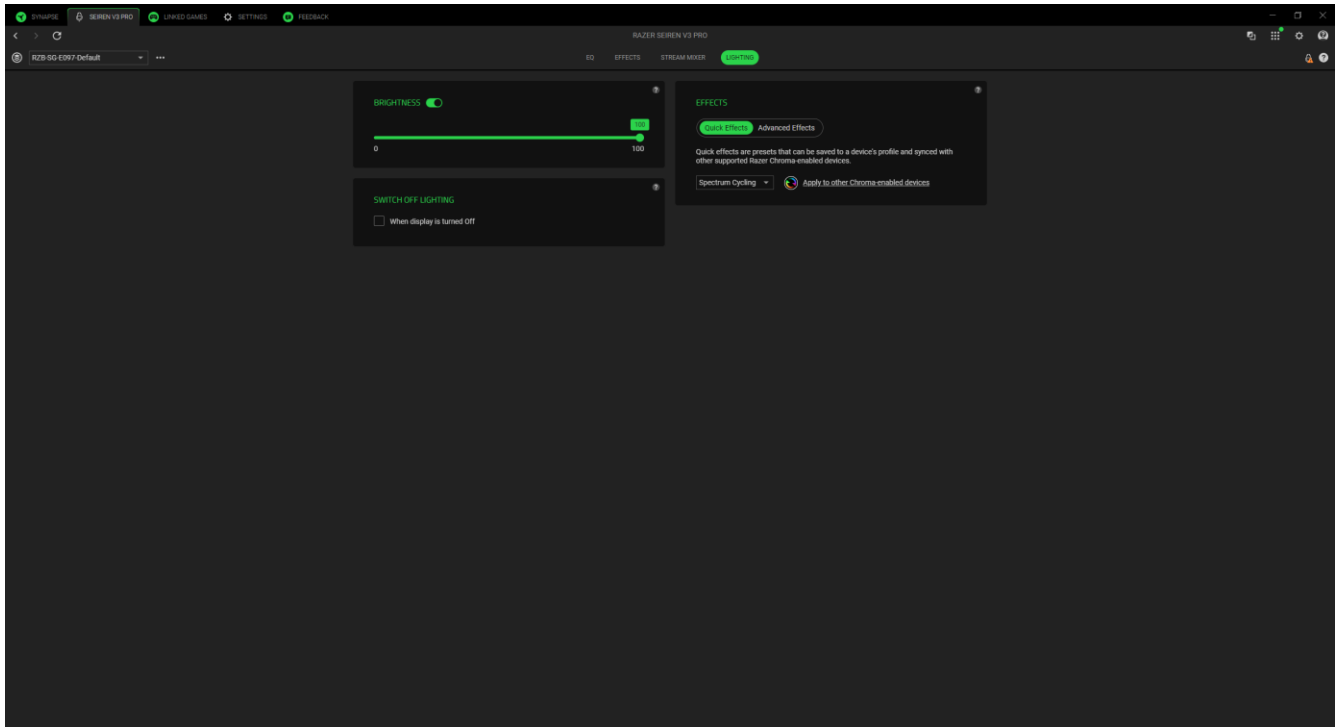

Brightness



You can turn off your Razer device's lighting by toggling the Brightness option or increase/decrease the luminance using the slider.







Switch Off Lighting

This is a power saving tool which allows you to disable your device's lighting in response to your system's display turning off and/or automatically power down when your device has been idle for a set amount of time.

Quick Effects

A number of quick effects can be selected and applied to your device's lighting, as listed here:

| | Name | Description | How to set up |
|---|-------------|--|---|
|  | Audio meter | The LED will light up according to the audio level with a default spectrum of colors | Select a Color Boost level |
|  | Breathing | The lighting will fade in and out of the selected color(s) | Select up to 2 colors or randomize colors |

| | | | |
|--|------------------|---|---|
|  | Fire | The LEDs will light up in warm colors to mimic the motion of flames | No further customization required |
|  | Spectrum cycling | The lighting will cycle between 16.8 million colors indefinitely | No further customization required |
|  | Starlight | Each LED will have a chance of fading in and out at a random time and duration | Select up to 2 colors or randomize colors and select a duration |
|  | Static | The LED will remain lit in the selected color | Select a color |
|  | Wave | The lighting will scroll in the direction selected | Select a wave direction |
|  | Wheel | The lighting will rotate in the direction selected with a default spectrum of colors. | Select a direction. |

If you have other supported Razer Chroma-enabled devices, you can synchronize their quick effects with your Razer device by clicking the Chroma Sync button ().

Advanced Effects

The Advanced Effects option allows you to choose a Chroma Effect Profile you want to use on your Razer Chroma-enabled peripheral. To start making your own Chroma Effect Profile, press the Launch Chroma Studio button ().

 *Some lighting effects listed here may not be available for your device. Only other Razer devices that support the selected lighting effect will synchronize. Indicator LEDs are not customizable.*

LINKED GAMES

The Linked Games tab allows you to add apps, view peripherals linked to apps, or search for listed apps.

Games

The Games subtab enables you to link apps to your peripherals. You can also sort apps based on alphabetical order, last played, or most played. Apps will still be listed here, even if not linked to a Razer device. To add an app that is not listed on the screen, you can use the Add button (+) to search for it manually or use the Scan button (🔍) to search for it automatically. Click the Search button (🔍) to look for a specific game or program from the list.

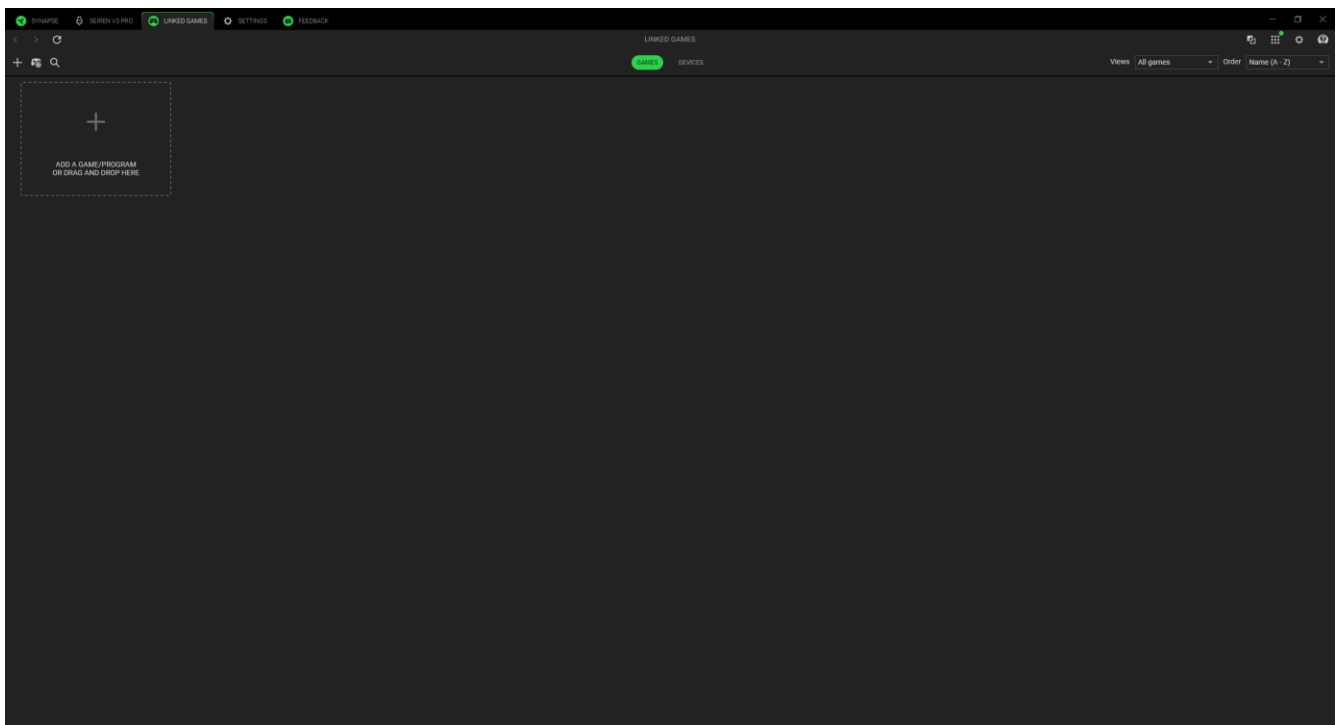

To link an app to your Razer device, click on it from the list and select a device and its profile. This will automatically set your device to the selected profile whenever you launch the app.

Devices

The Devices subtab lets you view your peripherals and determine which apps are linked to them. By selecting a device, you can see a list of linked apps, add new apps, or remove linked apps. You can filter these apps by using the Views and Order dropdown list. To add an app not listed on your peripheral, you can drag and drop the executable file inside the box or use the Add button (+) to open the search window. While inside the search window, you can click the Refresh button (↻) to rescan installed apps, the Search button (🔍) to look for a specific game or program from the list, or the Browse link to search for the app manually.

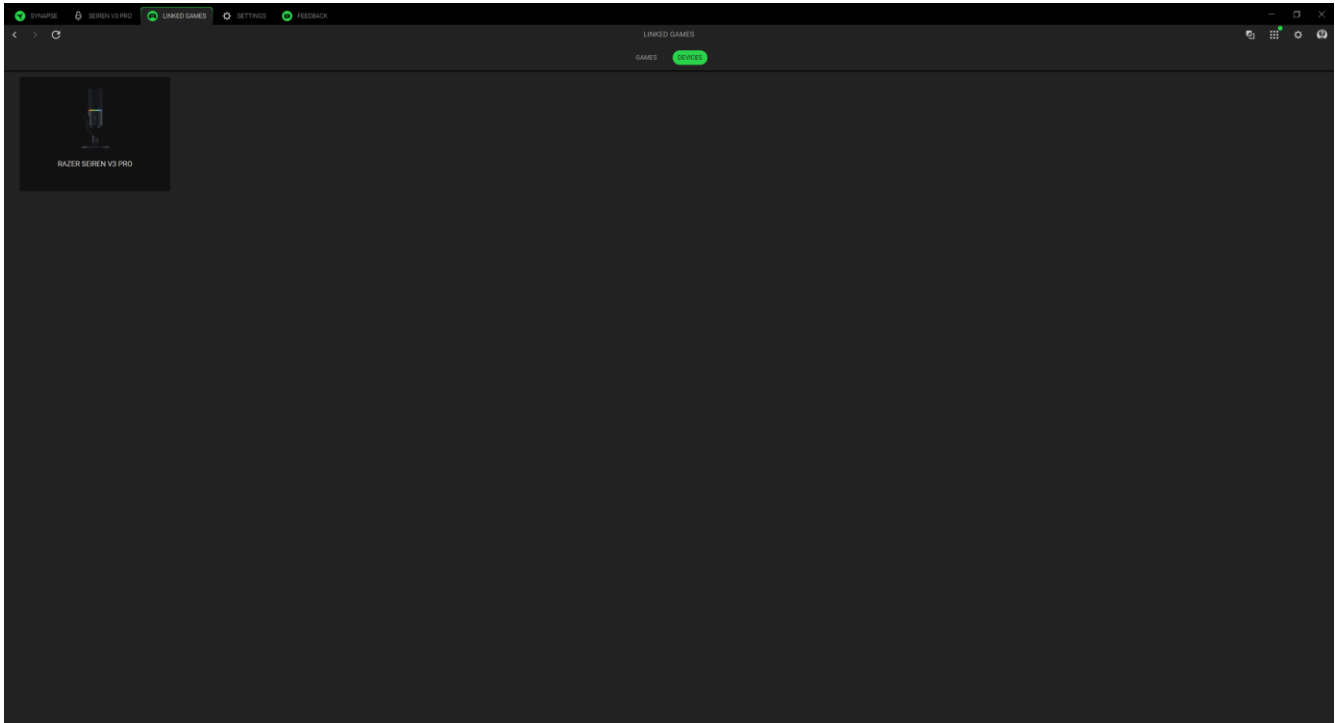

To link an app to your Razer device, click the tick box at the top left corner of the app while inside the search box. This will automatically set your device to the selected profile whenever you launch the app.

SETTINGS

The Settings tab, accessible by clicking the (⚙) button, enables you to configure numerous options as listed below:

Synapse

The Synapse subtab is where you can find options that are specific to the app.

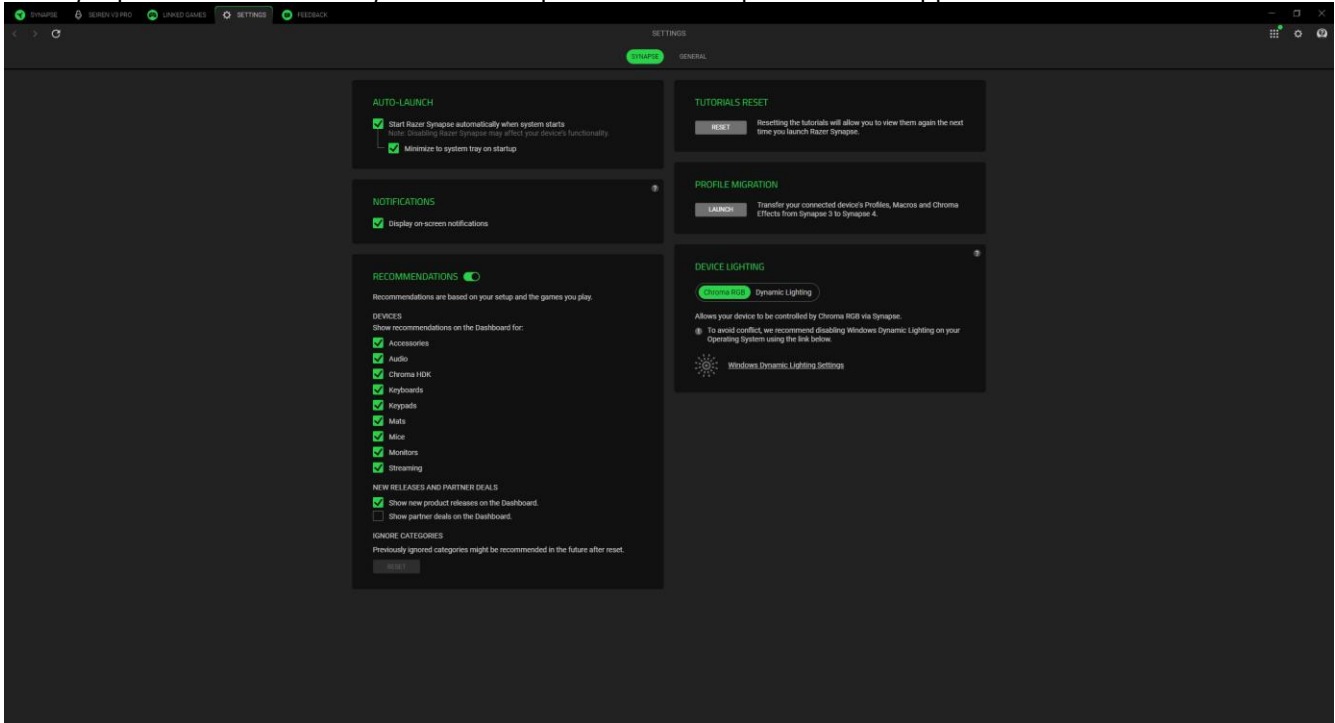

Auto Launch

The Auto Launch option enables you to configure the app's startup behavior.

Notifications

The Notifications option allows the app to display on-screen notifications even if you run full-screen apps.

Recommendations

Recommendations enable us to show the latest products and features on your Dashboard based on your installed devices and linked games.

Tutorials Reset

Selecting the Reset button will reactivate all tutorials that help you acquaint yourself with Razer Synapse's features.

Profile Migration

This function lets you transfer all your device's Profiles, Macros, and Chroma Effects from Synapse 3 to the new Synapse.

Device Lighting

This option lets you choose which app will control the lighting effects on your device.

General

The General subtab is the section where you can access miscellaneous options for your app, as well as find additional information about the software.

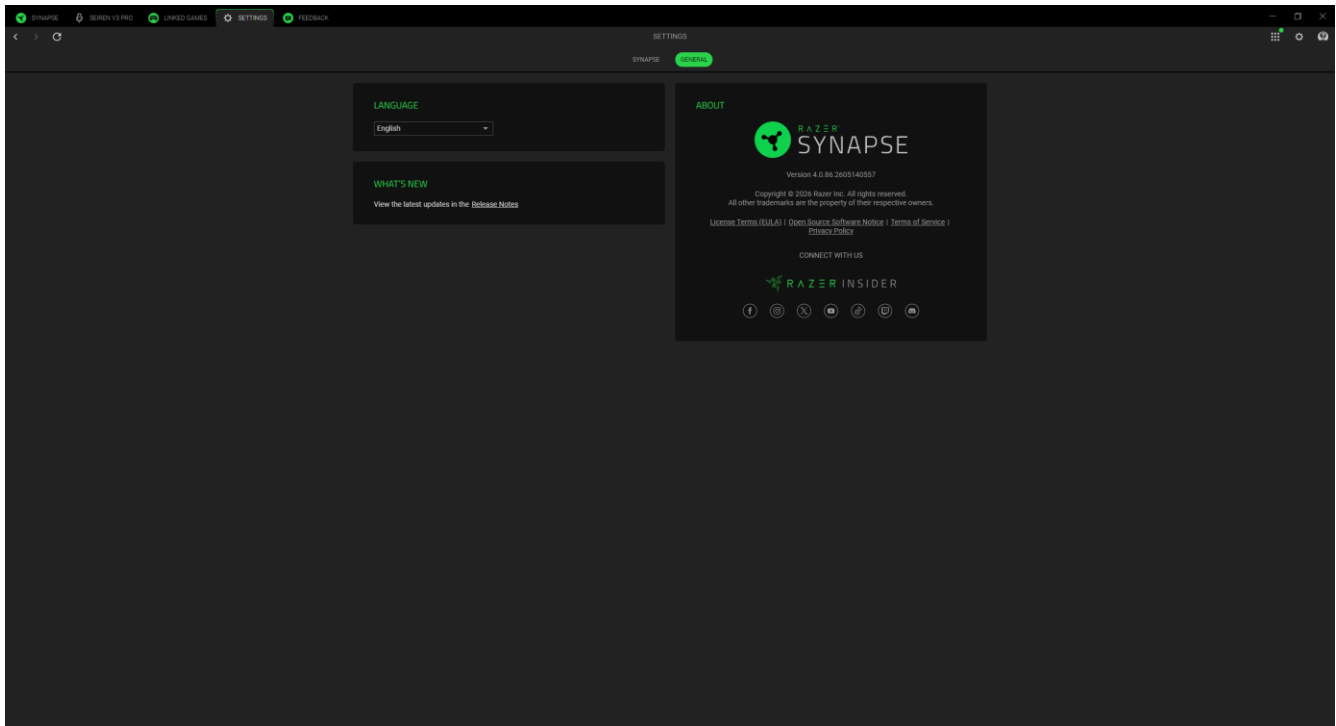

Language

This option lets you change the display language of Razer Synapse.

About

The About section shows the current software version, displays the copyright statement, and provides relevant links for Razer's terms of use. You may also use this option to access Razer's social communities quickly.

FEEDBACK

Help us improve Razer Synapse by giving your comments, suggestions, and problems with the software. You can contact us directly using this tab and even earn rewards for reporting bugs.

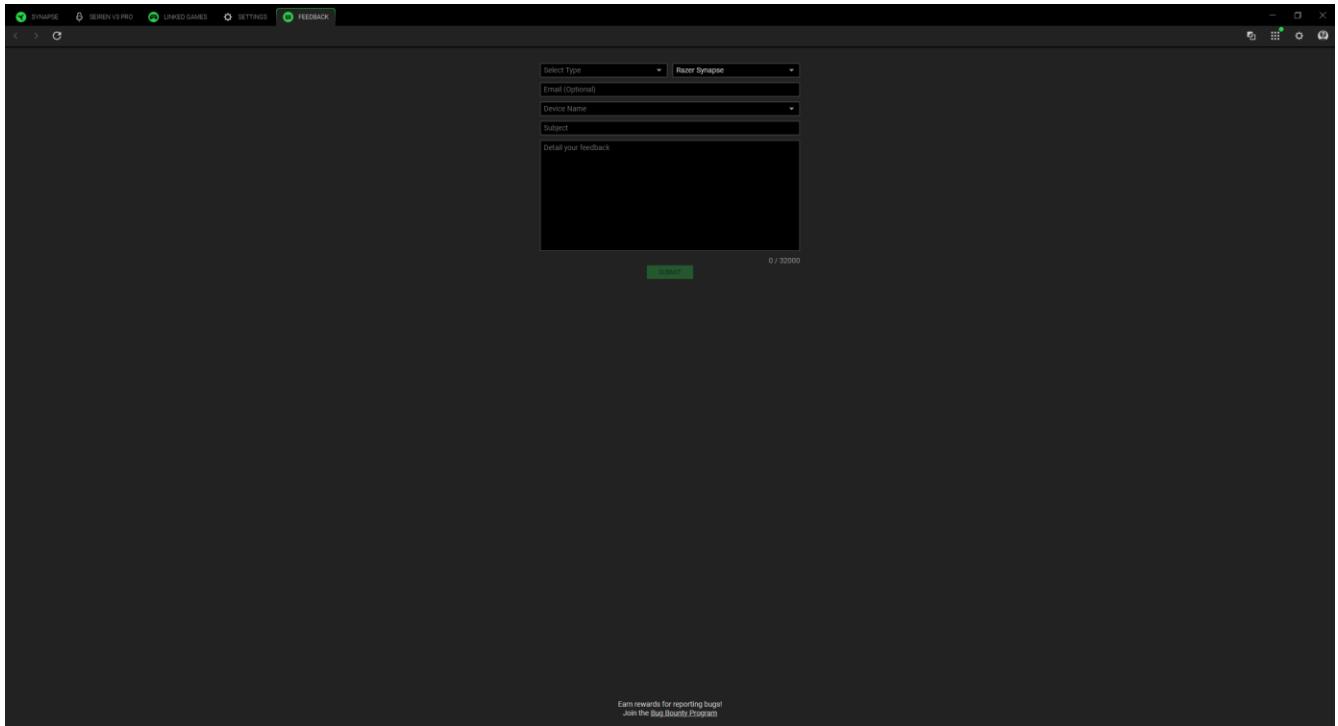

The screenshot shows the Razer Synapse Feedback form interface. At the top, there is a navigation bar with tabs for SYNAPSE, SERENITY PRO, SHARED GAMES, SETTINGS, and FEEDBACK. The FEEDBACK tab is active. The form includes a dropdown menu for 'Select Type' with 'Razer Synapse' selected. Below this are input fields for 'Email (Optional)', 'Device Name', and 'Subject'. A large text area is labeled 'Detail your feedback'. A green 'Submit' button is located at the bottom right of the form, with a character count '0 / 50000' next to it. At the bottom center of the page, there is a small text prompt: 'Earn rewards for reporting bugs! Join the Bug Bounty Program'.

7. SAFETY AND MAINTENANCE

SAFETY GUIDELINES

In order to achieve maximum safety while using the Razer Seiren V3 Pro, we suggest that you adopt the following guidelines:

Should you have trouble operating the device properly and troubleshooting does not work, unplug the device and contact the Razer hotline or go to support.razer.com for assistance. Do not attempt to service or fix the device yourself at any time.

Do not take apart the device, and do not attempt to operate it under abnormal current loads. Doing so will void your warranty.

Do not puncture nor insert foreign objects into any of the device's openings.

Keep the device and its components away from liquid, humidity or moisture. Operate the device and its components only within the specific temperature range of 0°C (32°F) to 40°C (104°F). Should the temperature exceed this range, unplug and switch off the device in order to let the temperature stabilize to an optimal level.

MAINTENANCE AND USE

The Razer Seiren V3 Pro requires minimum maintenance to keep it in optimum condition. Once a month we recommend you unplug the device from the computer and clean it using a soft cloth or cotton to prevent dirt buildup. Do not use soap or harsh cleaning agents.

8. LEGALESE

COPYRIGHT AND INTELLECTUAL PROPERTY INFORMATION

©2026 Razer Inc. All rights reserved. Razer, the triple-headed snake logo, Razer logo, and “For Gamers. By Gamers.” are trademarks or registered trademarks of Razer Inc. and/or affiliated companies in the United States or other countries. All other trademarks are the property of their respective owners.

Windows and the Windows logo are trademarks or registered trademarks of the Microsoft group of companies.

XSplit and XSplit Broadcaster are registered trademarks of SplitmediaLabs Limited.

Razer Inc. (“Razer”) may have copyright, trademarks, trade secrets, patents, patent applications, or other intellectual property rights (whether registered or unregistered) concerning the product in this guide. Furnishing of this guide does not give you a license to any such copyright, trademark, patent or other intellectual property right. The Razer Seiren V3 Pro (the “Product”) may differ from pictures whether on packaging or otherwise. Razer assumes no responsibility for such differences or for any errors that may appear. Information contained herein is subject to change without notice.

LIMITED PRODUCT WARRANTY

For the latest and current terms of the Limited Product Warranty, please visit razer.com/warranty.

LIMITATION OF LIABILITY

Razer shall in no event be liable for any lost profits, loss of information or data, special, incidental, indirect, punitive or consequential or incidental damages, arising in any way out of distribution of, sale of, resale of, use of, or inability to use the Product. In no event shall Razer’s liability exceed the retail purchase price of the Product.

GENERAL

These terms shall be governed by and construed under the laws of the jurisdiction in which the Product was purchased. If any term herein is held to be invalid or unenforceable, then such term (in so far as it is invalid or unenforceable) shall be given no effect and deemed to be excluded without invalidating any of the remaining terms. Razer reserves the right to amend any term at any time without notice.