



RAZER BOOMSLANG  
20TH ANNIVERSARY EDITION

MASTER GUIDE

# CONTENTS

1. WHAT'S INSIDE .....	2
2. WHAT'S NEEDED .....	4
3. LET'S GET YOU COVERED .....	4
4. GETTING STARTED .....	5
5. CONFIGURING YOUR RAZER BOOMSLANG 20TH ANNIVERSARY EDITION VIA RAZER SYNAPSE.	8
6. SAFETY AND MAINTENANCE .....	30
7. LEGALESE.....	32

## 1. WHAT'S INSIDE

- Razer Boomslang 20<sup>th</sup> Anniversary Edition

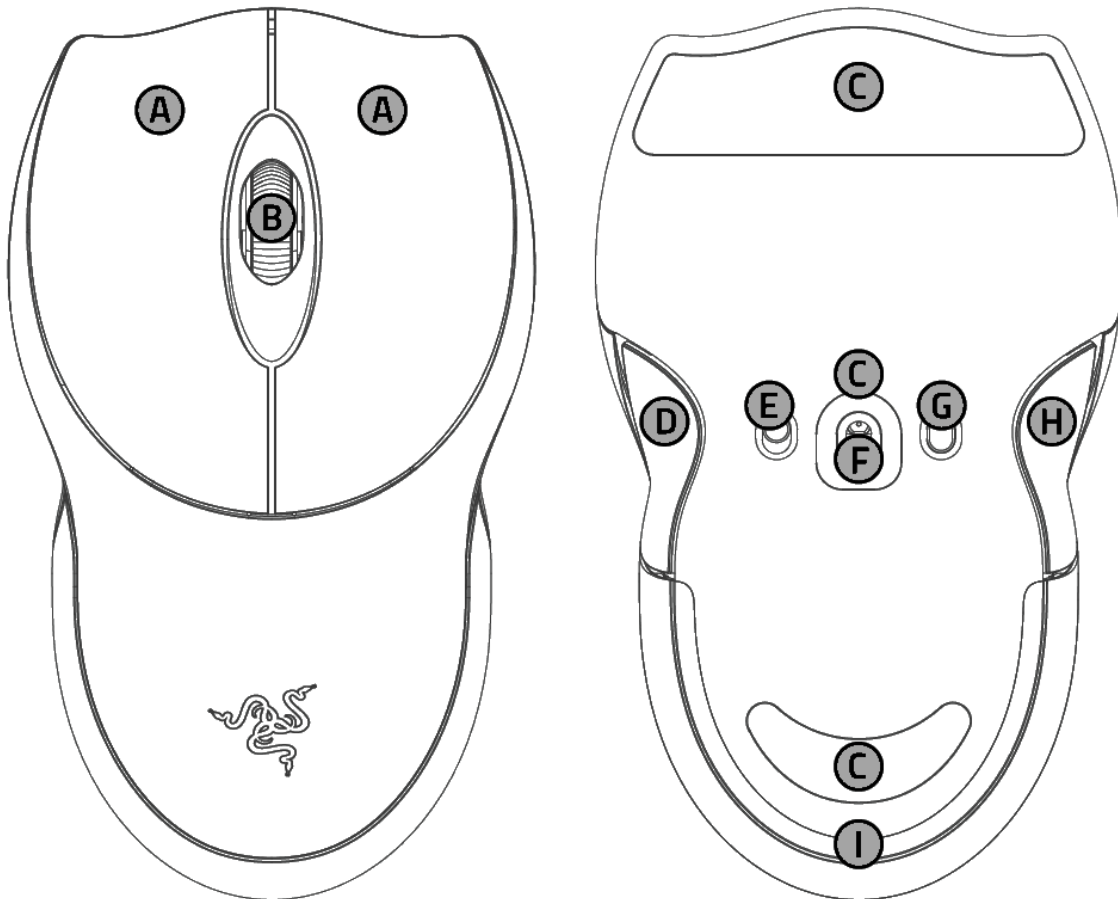

- A.** Razer™ Optical Mouse Switches Gen-4
  - PU leather left mouse button
  - PU leather right mouse button
- B.** Scroll wheel
- C.** PTFE mouse feet
- D.** PU leather mouse button 5
- E.** Power switch

- F.** Razer™ Focus Pro 45K Optical Sensor Gen-2
- G.** DPI stage cycle button
- H.** PU leather mouse button 4
- I.** Underglow lighting/status indicator



*The DPI stages are as follows: 400, 800, 1600 (default), 3200 and 6400. The DPI stages and polling rate can be customized using Razer Synapse.*

- Razer™ Mouse Dock Pro for Boomslang 20<sup>th</sup> Anniversary Edition

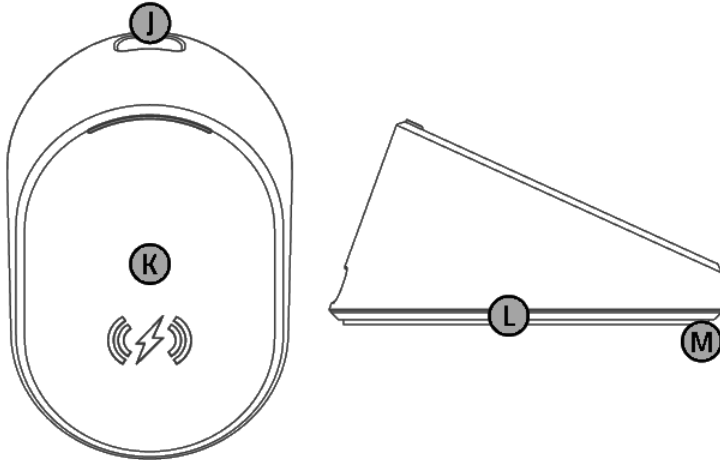

*This dock is not only a charging station but also a wireless receiver, specifically designed to work only with the included mouse.*

- J.** USB Type C port
  - K.** Magnetic wireless charging surface
  - L.** Underglow lighting/status indicator
  - M.** Anti-slip base
- 1.8m Braided USB Type A to USB Type C cable

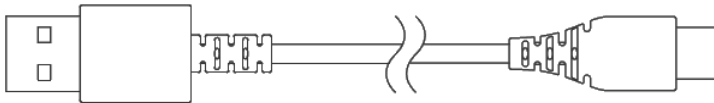

- Important Product Information Guide

---

## 2. WHAT'S NEEDED

### PRODUCT REQUIREMENTS

- USB Type A port

### RAZER SYNAPSE REQUIREMENTS

- Windows® 11 (or higher)
- Internet connection for software installation

---

## 3. LET'S GET YOU COVERED

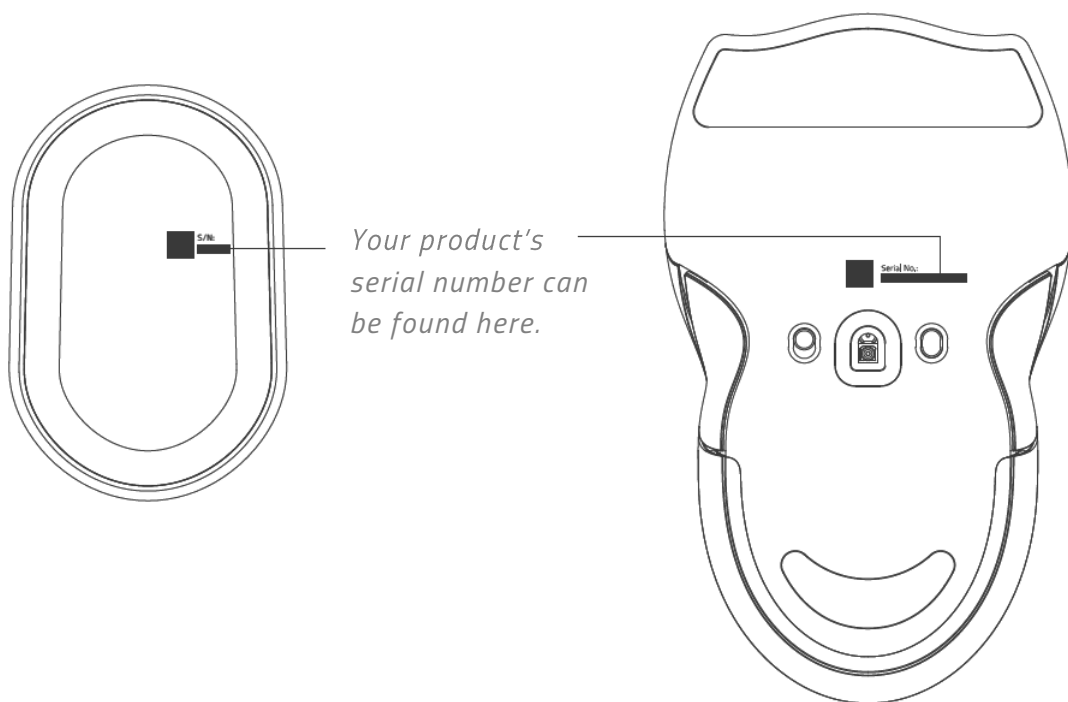

You've got a great device — now make it even better. Register your device at [razerid.razer.com](https://razerid.razer.com) to get covered and unlock exclusive Razer benefits.

**i** *A valid Proof of Purchase is required for any Limited Warranty Claim.*

---

## 4. GETTING STARTED

### CHARGE YOUR MOUSE

1.

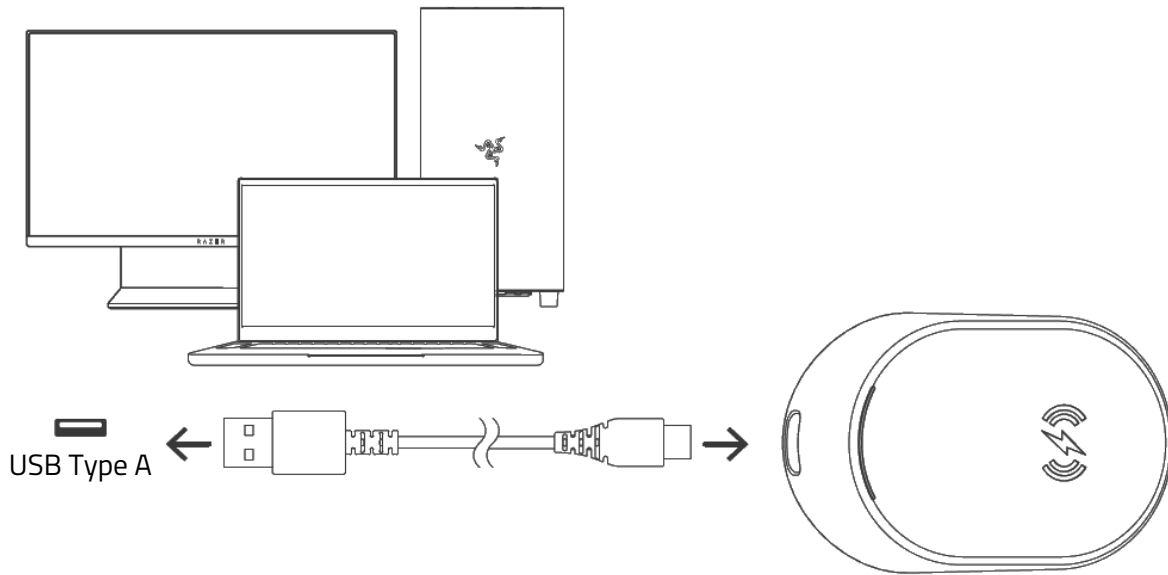

2.

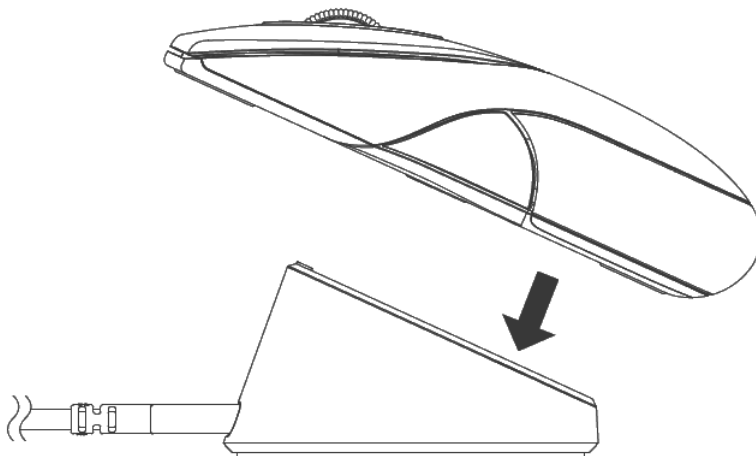

3.

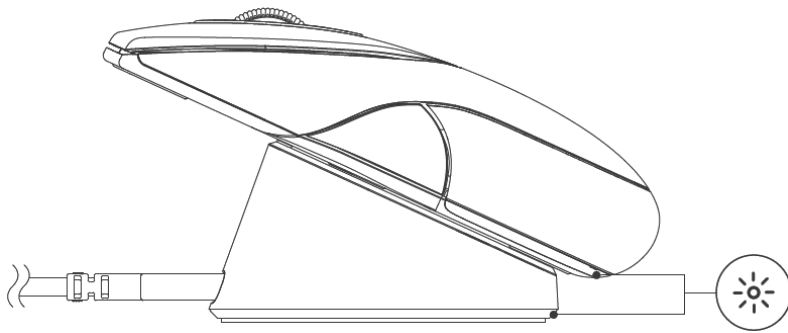

Battery Level	Status Indicators
Full	Static Green
High	Breathing Yellow
Mid	Breathing Orange
Low	Breathing Red



For best results, connect your Razer Mouse Dock Pro directly to your computer's USB port using the provided cable. A depleted battery will be fully charged in approximately 4 hours.

## LOW BATTERY WARNING

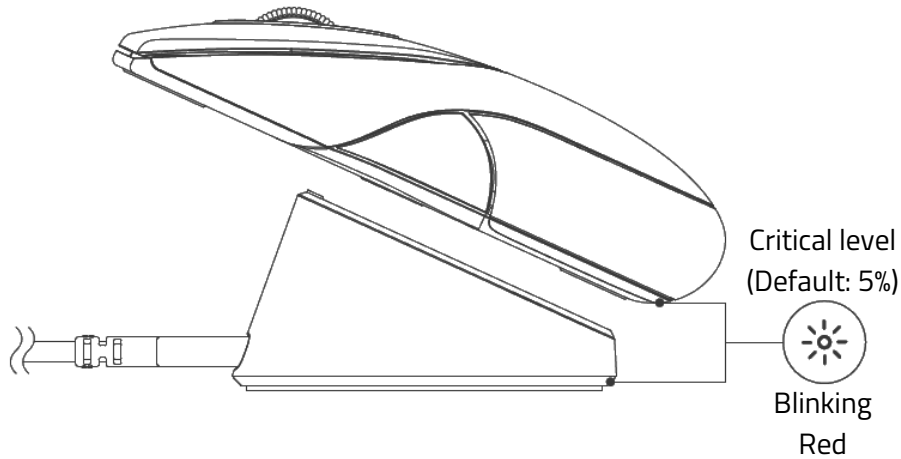

You can customize the percentage of the low battery warning using Razer Synapse.

## POWER ON / OFF

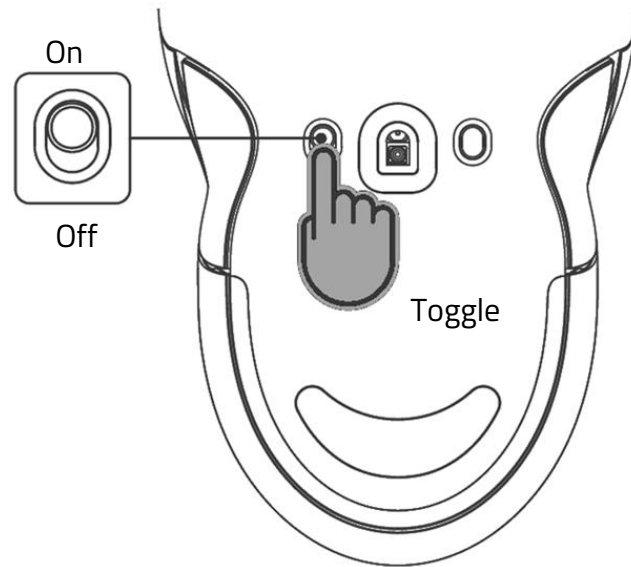

**i** *Install Razer Synapse when prompted or download the installer from [razer.com/synapse](https://www.razer.com/synapse).*

Find out more about your Collector's Edition Gaming Mouse at [support.razer.com](https://support.razer.com)

---

## 5. CONFIGURING YOUR RAZER BOOMSLANG 20TH ANNIVERSARY EDITION VIA RAZER SYNAPSE

**i** *Disclaimer: This guide provides an overview of the New Razer Synapse app and may only partially cover some of the features of your device. The New Razer Synapse requires an Internet connection to install, update, access, and save cloud-based features. Registering for a Razer ID account is recommended but optional. All features listed here are subject to change based on the current version, connected device(s), and supported add-ons.*

### SYNAPSE

The Synapse tab is your default tab when you first launch Razer Synapse. Use the following buttons below to navigate the user interface:

— Minimize

Clicking this button will minimize the app to the taskbar while it runs in the background.

☐ Maximize

This button expands the browser window to fill the entire screen. To restore the window to its original size, click the maximize button again.

✕ Close

This button will close all relevant tabs and terminate the application completely.

< Previous Tab

Clicking this button will return you to the last tab you have visited.

> Next Tab

Clicking this button will move you to the next page if you've recently used the Previous Tab button.

🔄 Refresh Tab

This button reloads the current page. Use this if a page isn't displaying correctly or you want to see the latest content.

↓ Download Update

If this button appears, that means there are changes to the app. Use this if a page isn't displaying correctly or you want to see the latest content.

### ☰ More

Clicking this button will open a pop-up so you can easily access your Devices, Modules, and Other Installed Apps tabs.

### ⚙ Settings

Clicking this button will open the Settings tab, so you can quickly change the settings to this app.

### 👤 Profile

This button will open a pop-up to access the Log In, Feedback, Rate This Software, Add WiFi Device, and Exit options.

### ❓ Info

Hovering over this button will pop up an additional information about a feature or function.

## Dashboard

The Dashboard subtab is an overview of your Razer Synapse, where you can access all your Razer devices, modules, and online services.

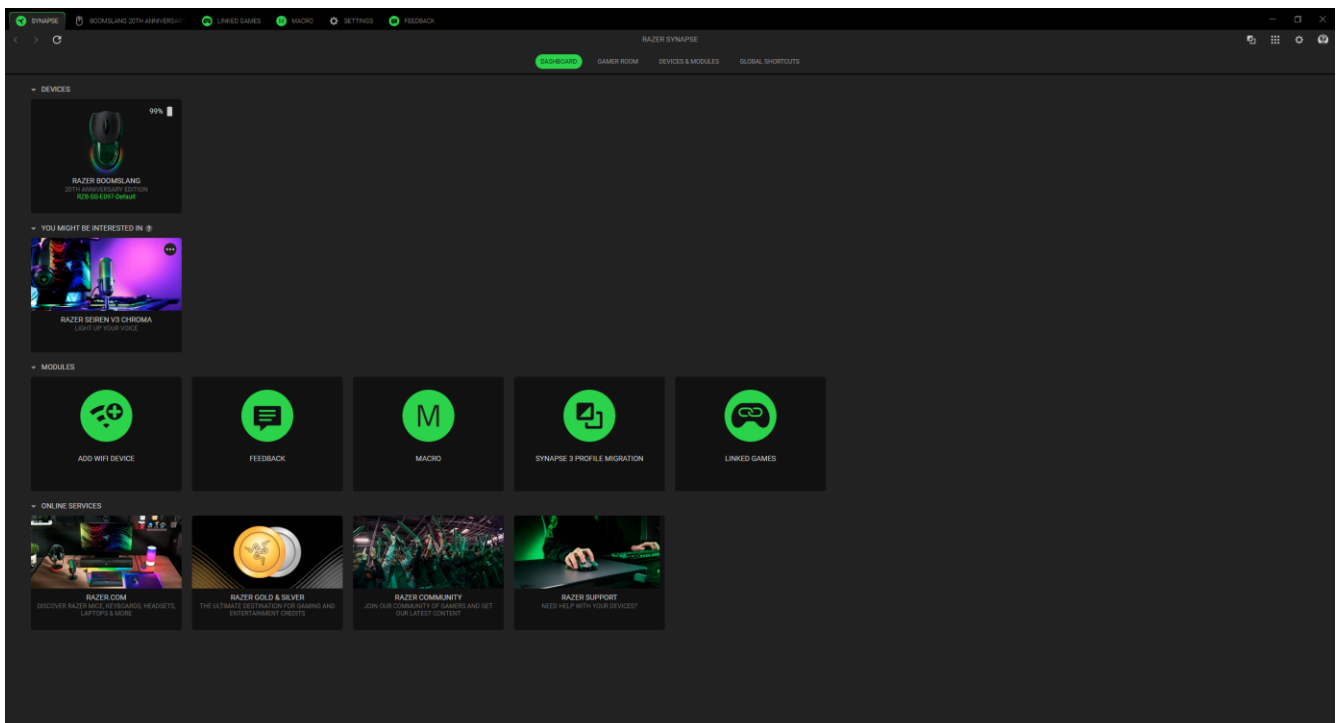

## Gamer Room

The Gamer Room subtab shows all devices with the Razer Aether Light feature. From here, you can view and manage your Gamer Room-supported devices.

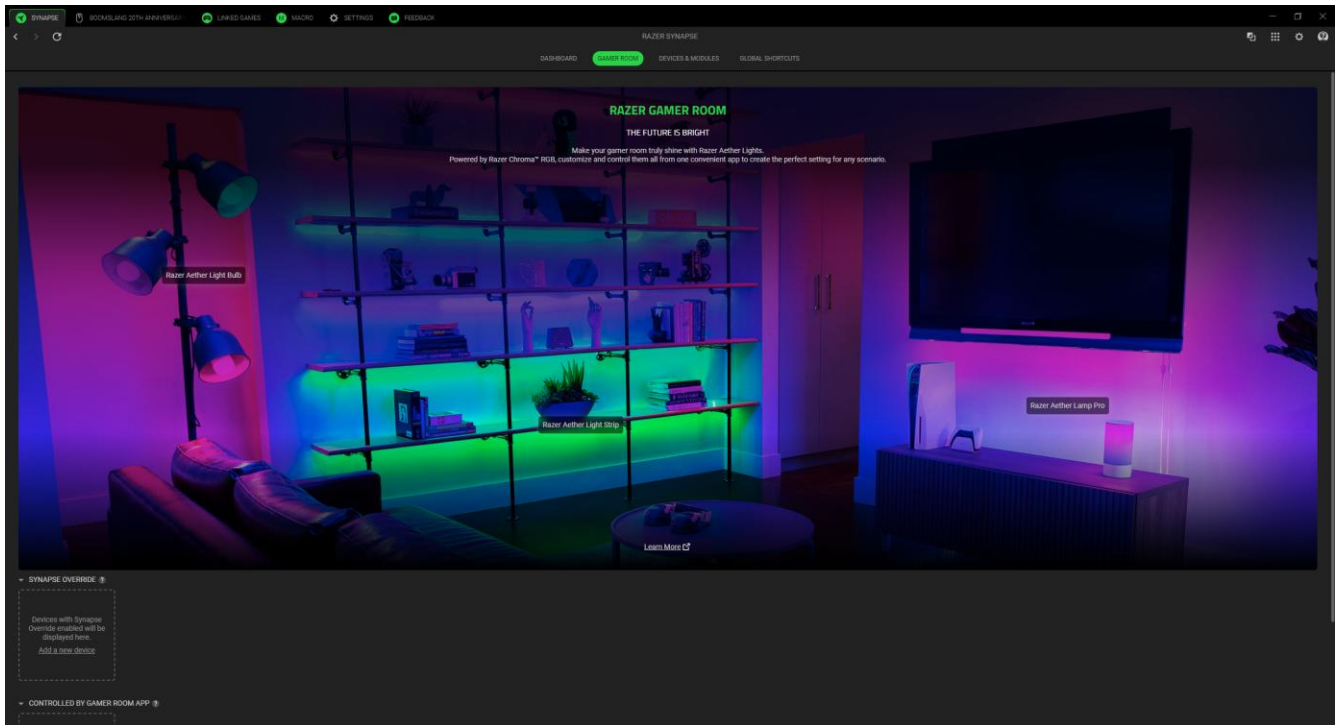

### *Synapse Override*

This section allows you to select and customize your device's lighting and make it react to Chroma-enabled games and Chroma Connect apps using Razer Synapse.

### *Controlled By Gamer Room App*

This section displays all supported devices controlled remotely by the Gamer Room app.

## Devices & Modules

The Modules subtab displays all installed and available modules for installation.

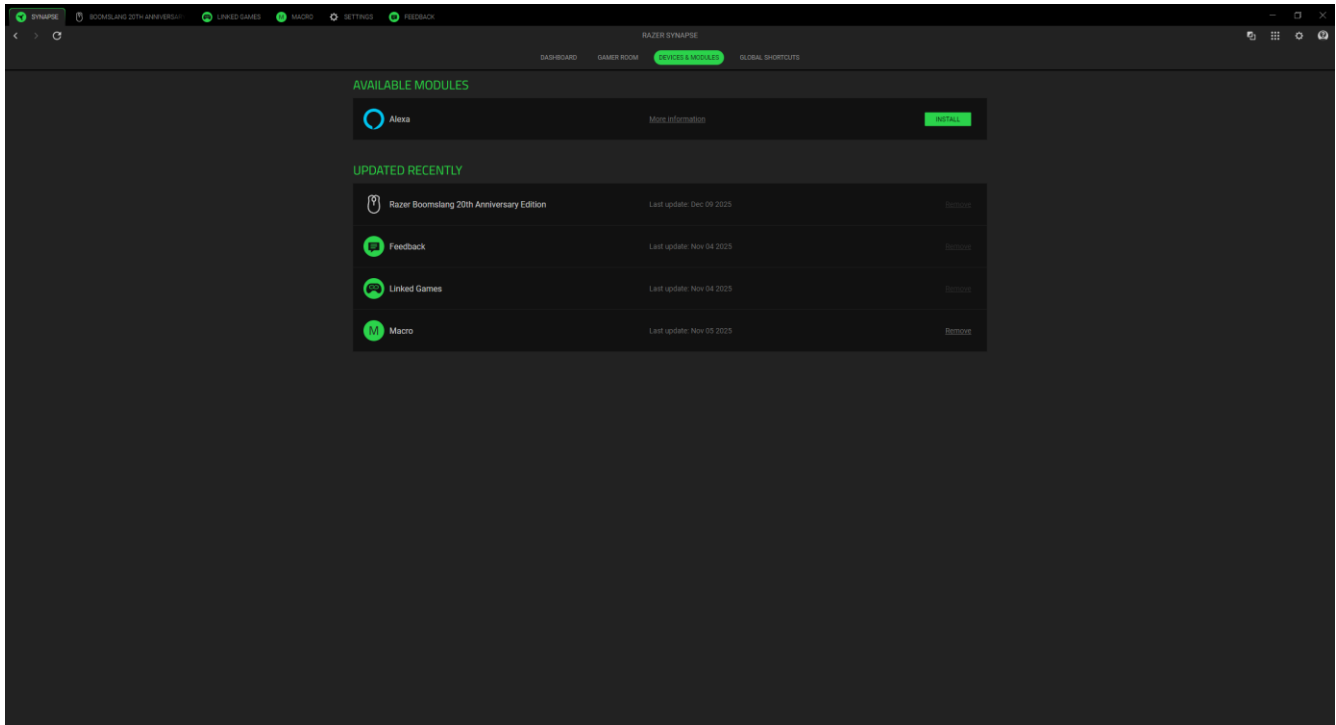

## Global Shortcuts

Bind operations or Razer Synapse functions to custom key-combinations from any Razer Synapse-enabled device inputs, which apply across all device profiles.

 *Only Razer Synapse-enabled device inputs will be recognized.*

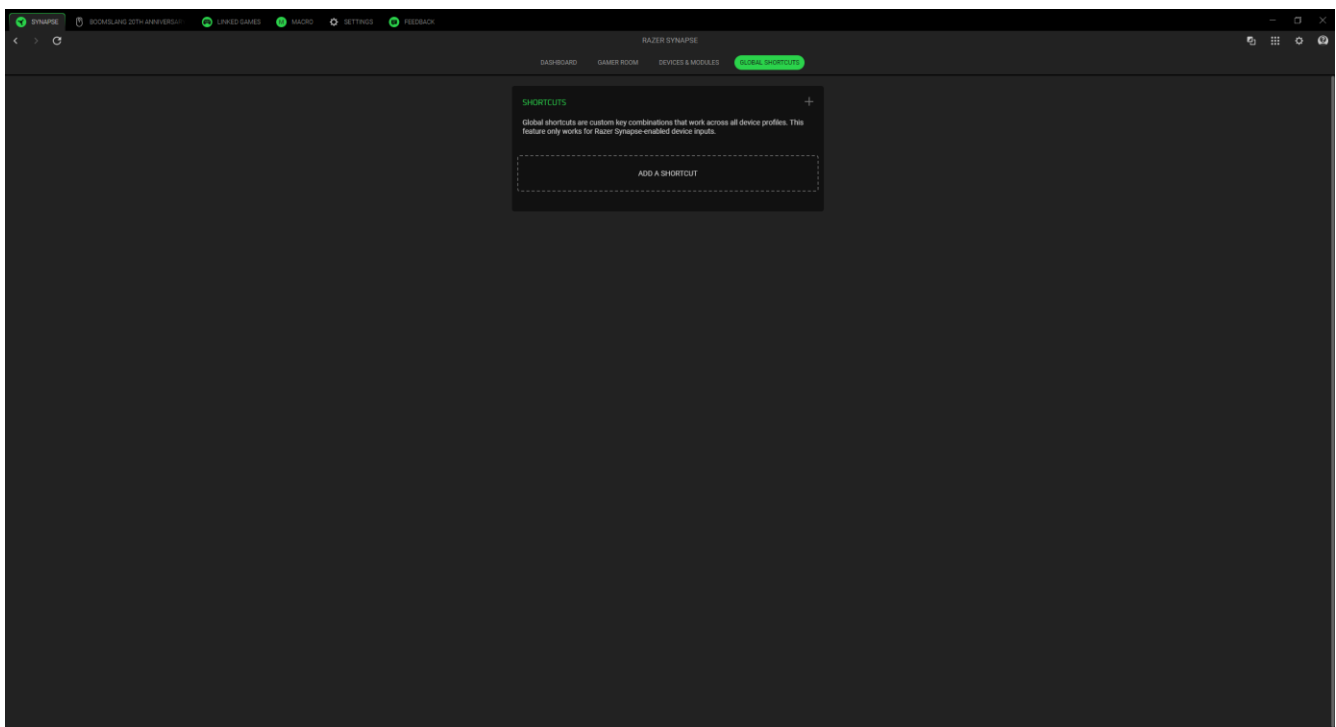

## RAZER BOOMSLANG 20TH ANNIVERSARY EDITION

The Razer Boomslang 20th Anniversary Edition tab is the main tab for your Razer mouse. You can change your device settings from here, such as button assignment, stored profiles, DPI sensitivity, and polling rate. Any changes under this tab will be saved automatically to your local system and cloud storage. Use the following buttons below to access your profile options:

 Profiles Dropdown Bar

Clicking this dropdown bar will display all the profiles for this device so you can quickly change profiles.

 Miscellaneous



Clicking this button will open a pop-up with options related to your current profile.

### Customize

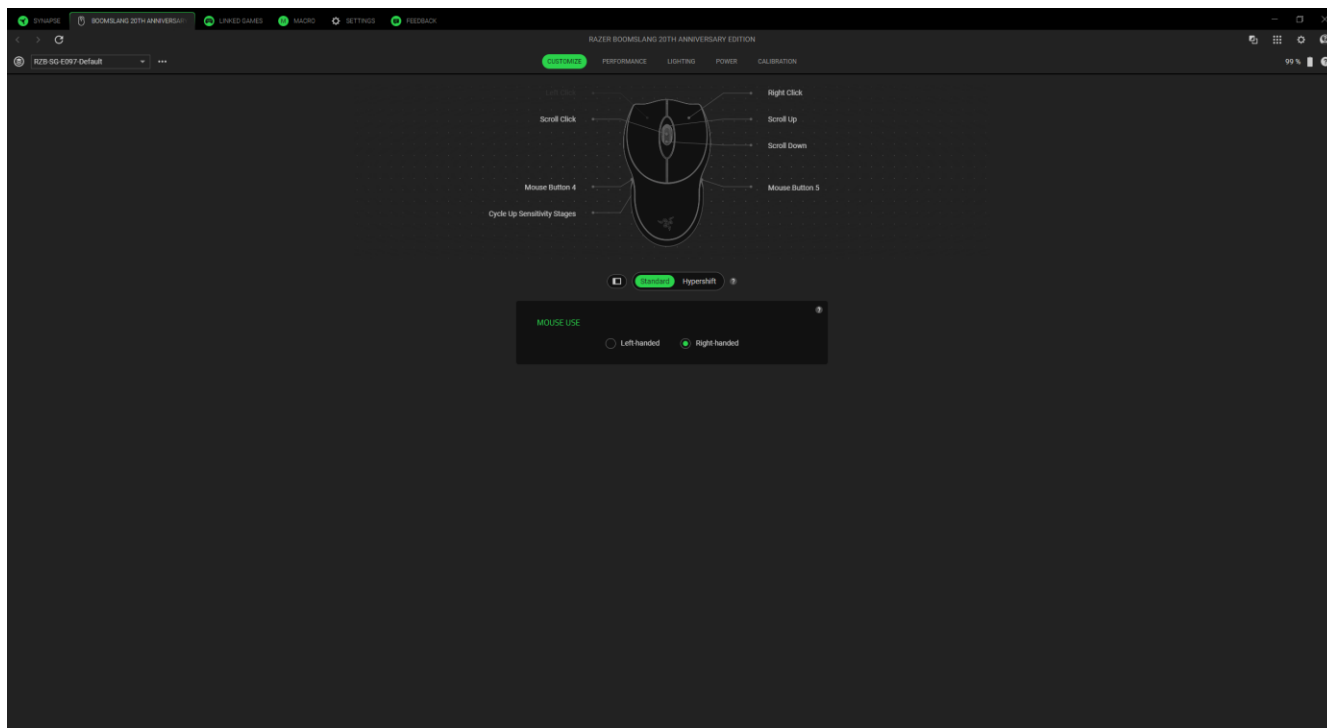
The Customize subtab is for modifying your mouse's button assignments.



### Profile

Profile is a data storage system that keeps all your Razer device settings. By default, the profile name is based on your system's name. Clicking the dropdown bar () will display all profiles for this device so you can quickly switch between them. To add, import, rename, duplicate, export, or delete a profile, press the profile's corresponding Miscellaneous button ().

## Standard / Hypershift

Hypershift mode is a secondary set of button assignments activated when the Hypershift key is held down. By default, the Hypershift key is assigned to the fn key of your Razer Synapse-supported keyboard. However, you can also set any mouse button as a Hypershift key.

## Remap Menu

Clicking the Remap Menu button (  ) will reveal all current assignments for your Razer mouse and allow you to modify them.

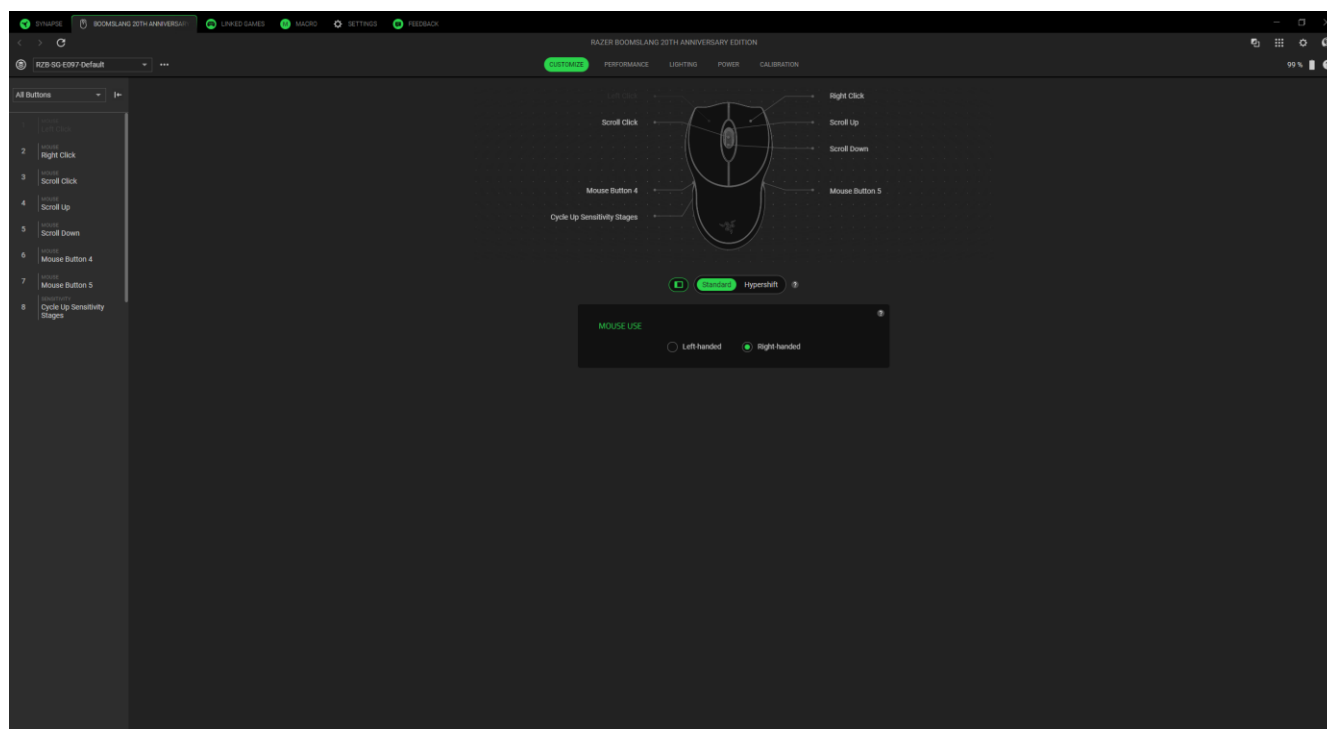

Alternatively, you can skip to a specific assignment by selecting it on the Customize tab.

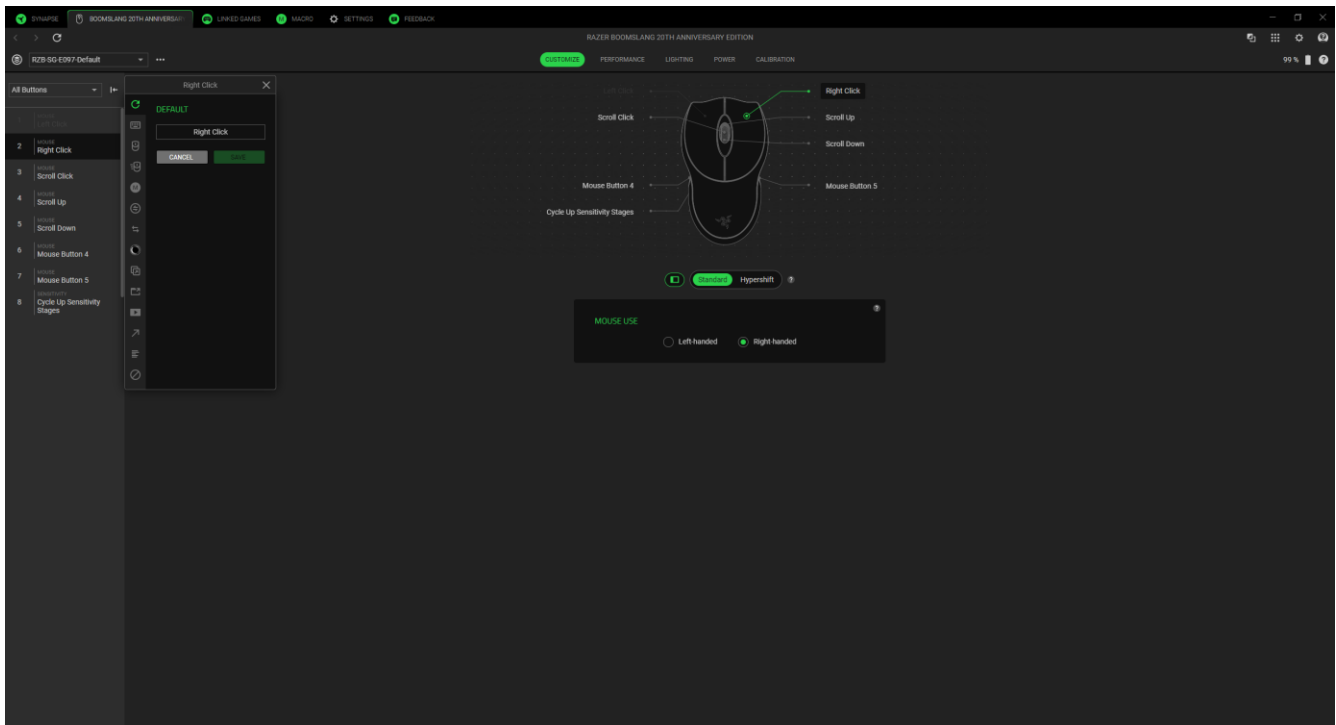

Upon selecting an assignment, you may then change it to one of the following functions:

#### Default

This option enables you to return the selected button to its original setting.

#### Keyboard Function

This option changes the button assignment into a keyboard function. You can also enable Turbo mode, which allows you to emulate a repeated keyboard function while the button is held down.

#### Mouse Function

This option substitutes the current button assignment for another mouse function. Listed below are the functions which you can choose from:

- Left Click - Performs a left mouse click using the assigned button.
- Right Click - Performs a right mouse click using the assigned button.
- Scroll Click - Activates the universal scrolling function.
- Double Click - Performs a double left click using the assigned button.
- Scroll Up - Performs a "Scroll Up" command using the assigned button.
- Scroll Down - Performs a "Scroll Down" command using the assigned button.

- Mouse Button 4 - Performs a "Backward" command for most internet browsers.
- Mouse Button 5 - Performs a "Forward" command for most internet browsers.
- Scroll Left - Performs a "Scroll Left" command using the assigned button.
- Scroll Right - Performs a "Scroll Right" command using the assigned button.

You can also choose to enable Turbo mode in some of the mouse functions, which allow you to emulate repeatedly pressing and releasing said function while the button is held down.

## Sensitivity

This function allows you to manipulate the DPI setting of your Razer Boomslang 20th Anniversary Edition with a touch of a button. Listed below are the Sensitivity options and their description:

- Sensitivity Clutch - Changes the sensitivity to a predefined DPI while the designated button is held down. Releasing the button will return it to the previous sensitivity.
- Sensitivity Stage Up - Increases the current sensitivity by one stage.
- Sensitivity Stage Down - Decreases the current sensitivity by one stage.
- On-The-Fly Sensitivity - Pressing the designated button and moving the scroll wheel either up or down will increase or decrease the current DPI respectively.
- Cycle Up Sensitivity Stages - Increases the current sensitivity stage by one. Once it reaches the highest sensitivity stage, it will return to stage 1 when the button is pressed again.
- Cycle Down Sensitivity Stages - Decreases the current sensitivity stage by one. Once it reaches stage 1, it will return to the highest sensitivity stage when the button is pressed again.

## Macro

A Macro is a prerecorded sequence of keystrokes and button presses that is executed with precise timing. By setting the button function to Macro, you can conveniently execute a chain of commands. This function will only be visible when the Macro module is installed.

## Inter-device

Inter-device allows you to change the functionality of other Razer Synapse-enabled devices. Some of these functionalities are device-specific such as using your Razer gaming keyboard to change the Sensitivity Stage of your Razer gaming mouse.

## Switch Profile

Switch Profile lets you quickly change profiles and load a new set of button assignments. An on-screen notification will appear whenever you switch profiles.

## Switch Chroma Effect

Switch Chroma Effect allows you to easily switch between all Chroma Effect Profiles in Chroma Studio. This function will only be visible when the Chroma Studio module is installed.

## Razer Hypershift

Setting the button to Razer Hypershift will allow you to activate Hypershift mode as long as the button is held down.

## Launch

Launch Program lets you open an app or a website using the assigned button. When you select Launch Program, two choices will appear, which require you to search for a specific app you want to open or write the website address you want to visit.

## Multimedia

This option allows you to assign multimedia controls to your Razer device. Listed below are the multimedia controls you can choose from:

- Volume Down - Decreases the audio output.
- Volume Up - Increases the audio output.
- Mute Volume - Mutes the audio.
- Mic Volume Up - Increases the microphone volume.
- Mic Volume Down - Decreases the microphone volume.
- Mute Mic - Mutes the microphone.
- Mute All - Mutes both microphone and audio output.
- Play / Pause - Play, pause, or resume current media playback.
- Previous Track - Play the previous media track.
- Next Track - Play the next media track.

## ↗ Windows Shortcuts

This option allows you to assign your preferred button to a Windows Operating System shortcut command. For more information, please visit: [support.microsoft.com/kb/126449](https://support.microsoft.com/kb/126449)

## ☰ Text Function

Text Function enables you to type a prewritten text with a touch of a button. Simply write your desired text on the given field, and your text will be typed whenever the assigned button is pressed. This function has full Unicode support, and you can also insert special symbols from character maps.

## ⊘ Disable

This option renders the assigned button unusable. Use Disable if you do not want to use the selected button or if it interferes with your gaming.

## Performance

The Performance subtab enables you to adjust the sensitivity, acceleration, and polling rate of your Razer mouse.

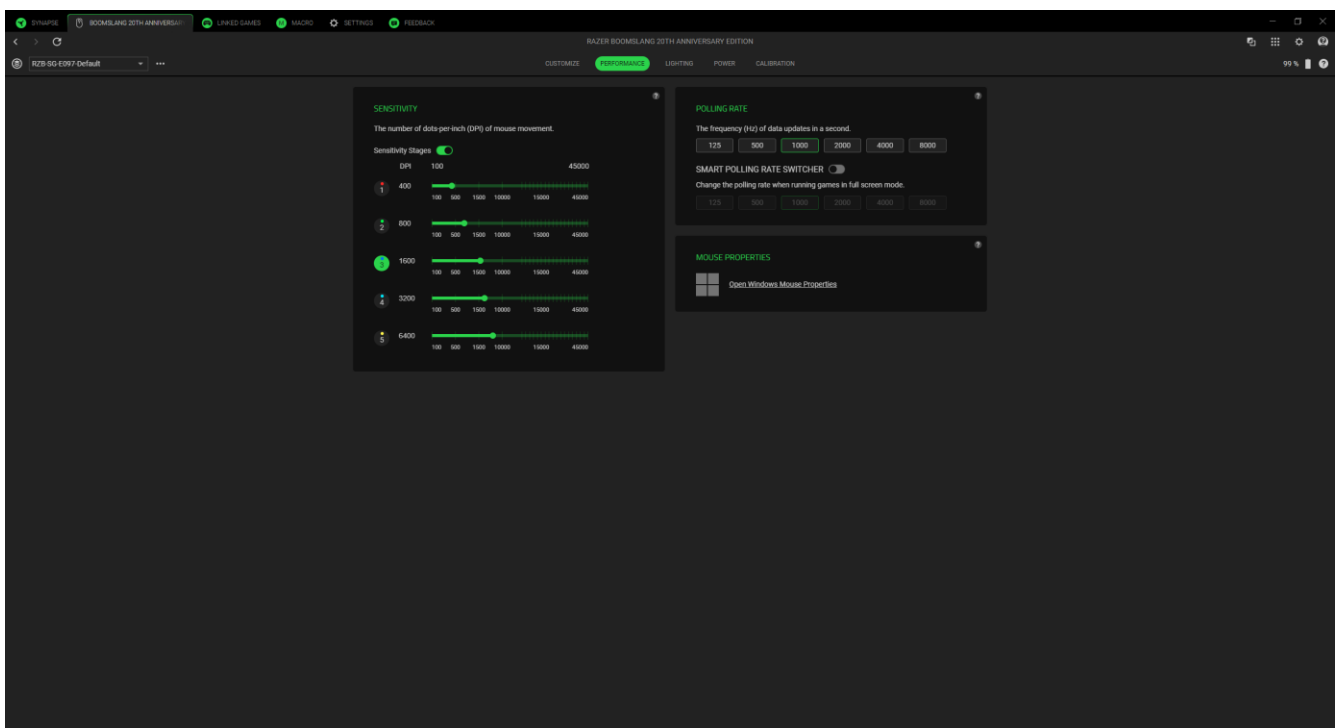

## *Sensitivity*

Sensitivity refers to the distance the cursor will travel based on how far the mouse moved. The higher the DPI, the farther the cursor will travel, given the same mouse movement distance.

## Sensitivity Stages

A sensitivity stage is a preset sensitivity value. You can create up to 5 different sensitivity stages, which you can cycle through using the DPI cycle button or DPI Stage Up / down buttons on your Razer mouse.

## Polling Rate

You can switch between any of the polling rate options by selecting your desired polling rate. The higher the polling rate, the more often the computer receives information about your mouse's status, effectively reducing input latency and improving your mouse pointer's reaction time.

## Smart Polling Rate Switcher

Change your mouse's polling rate automatically when you start a game in full-screen mode.

## Mouse Properties

Access the Windows Mouse Properties, where you can modify operating system settings that directly affect your Razer mouse.

## Lighting

The Lighting subtab enables you to modify your Razer device's light settings.

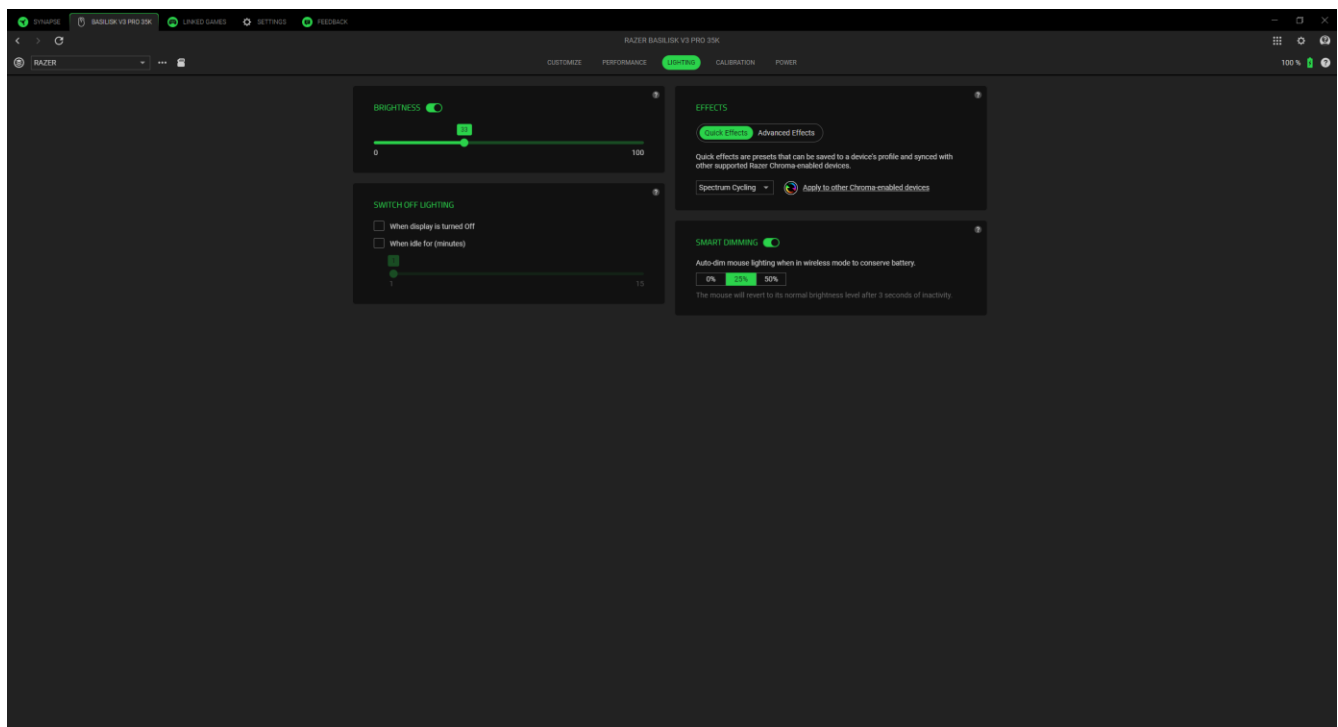

## Brightness

You can turn off your Razer device's lighting by toggling the Brightness option or increase/decrease the luminance using the slider. You can also adjust the brightness of the dock and mouse together or separately.

### Switch Off Lighting

This is a power saving tool which allows you to disable your device's lighting in response to your system's display turning off and/or automatically power down when your device has been idle for a set amount of time.

### Quick Effects

A number of quick effects can be selected and applied to your device's lighting, as listed here:

	Name	Description	How to set up
	Audio meter	The mouse will light up according to the audio level with a default spectrum of colors	Select a Color Boost level
	Breathing	The lighting will fade in and out of the selected color(s)	Select up to 2 colors or randomize colors
	Fire	The LEDs will light up in warm colors to mimic the motion of flames	No further customization required
	Reactive	The mouse will light up when you click any of the mouse buttons	Select a color and a duration
	Spectrum cycling	The lighting will cycle between 16.8 million colors indefinitely	No further customization required
	Starlight	Each LED will have a chance of fading in and out at a random time and duration	Select up to 2 colors or randomize colors and select a duration
	Static	The mouse will remain lit in the selected color	Select a color
	Wave	The lighting will scroll in the direction selected	Select a wave direction

If you have other supported Razer Chroma-enabled devices, you can synchronize their quick effects with your Razer device by clicking the Chroma Sync button (  ).

## Advanced Effects

The Advanced Effects option allows you to choose a Chroma Effect Profile you want to use on your Razer Chroma-enabled peripheral. To start making your own Chroma Effect Profile, press the Launch Chroma Studio button (  ).

 *Some lighting effects listed here may not be available for your device. Only other Razer devices that support the selected lighting effect will synchronize. Indicator LEDs are not customizable.*

## Smart Dimming

Enable Smart Dimming to conserve battery life when your device is in Wireless Mode.

## Power

The Power subtab allows you to manage your device's energy consumption when running on batteries. You can also set your device to enter sleep mode when it has been idle for a certain amount of time.

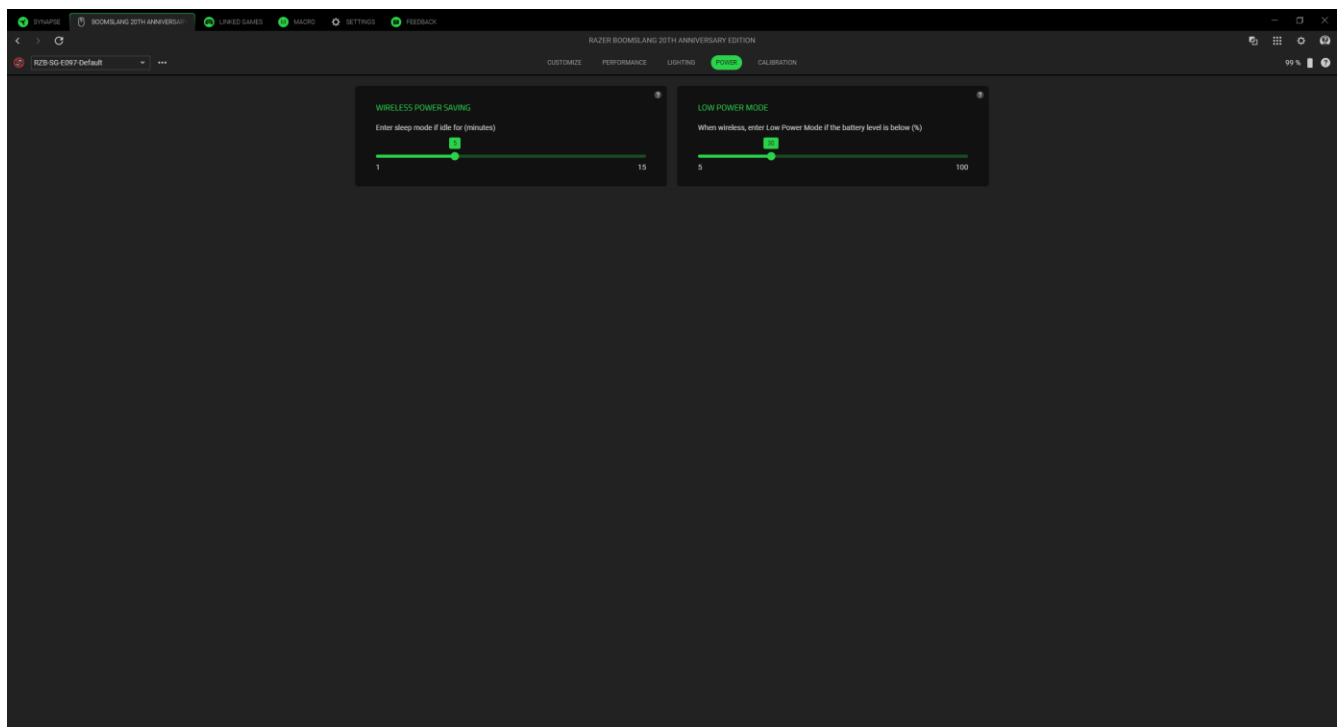

## Calibration

The Calibration subtab allows you to optimize the sensor of your Razer mouse to any surface for better tracking.

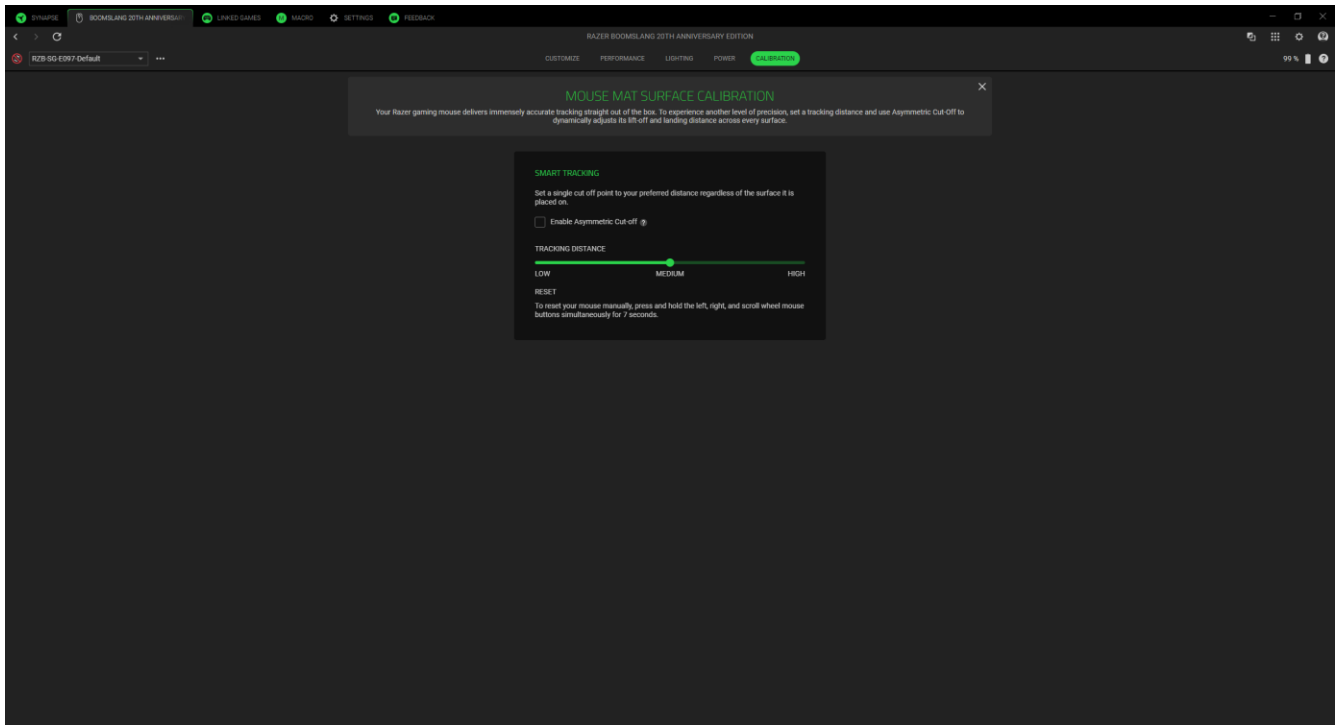

### *Smart Tracking*

Smart Tracking lets you set the distance at which the sensor stops tracking when it is lifted from its surface to avoid unwanted cursor movement.

### *Enable Asymmetric Cut-Off*

By selecting the Enable Asymmetric Cut-Off option, you may set different values for the lift-off and landing distances. Please ensure that you test these distances thoroughly, as setting them too low may cause compatibility issues with the surface.

### *Tracking Distance*

Adjust the slider to set the specific vertical height at which the sensor stops tracking the mouse when it is lifted.

## LINKED GAMES

The Linked Games tab allows you to add apps, view peripherals linked to apps, or search for listed apps.

### Games

The Games subtab enables you to link apps to your peripherals. You can also sort apps based on alphabetical order, last played, or most played. Apps will still be listed here, even if not linked to a Razer device. To add an app that is not listed on the screen, you can use the Add button ( + ) to search for it manually or use the Scan button ( 📷 ) to search for it automatically. Click the Search button ( 🔍 ) to look for a specific game or program from the list.

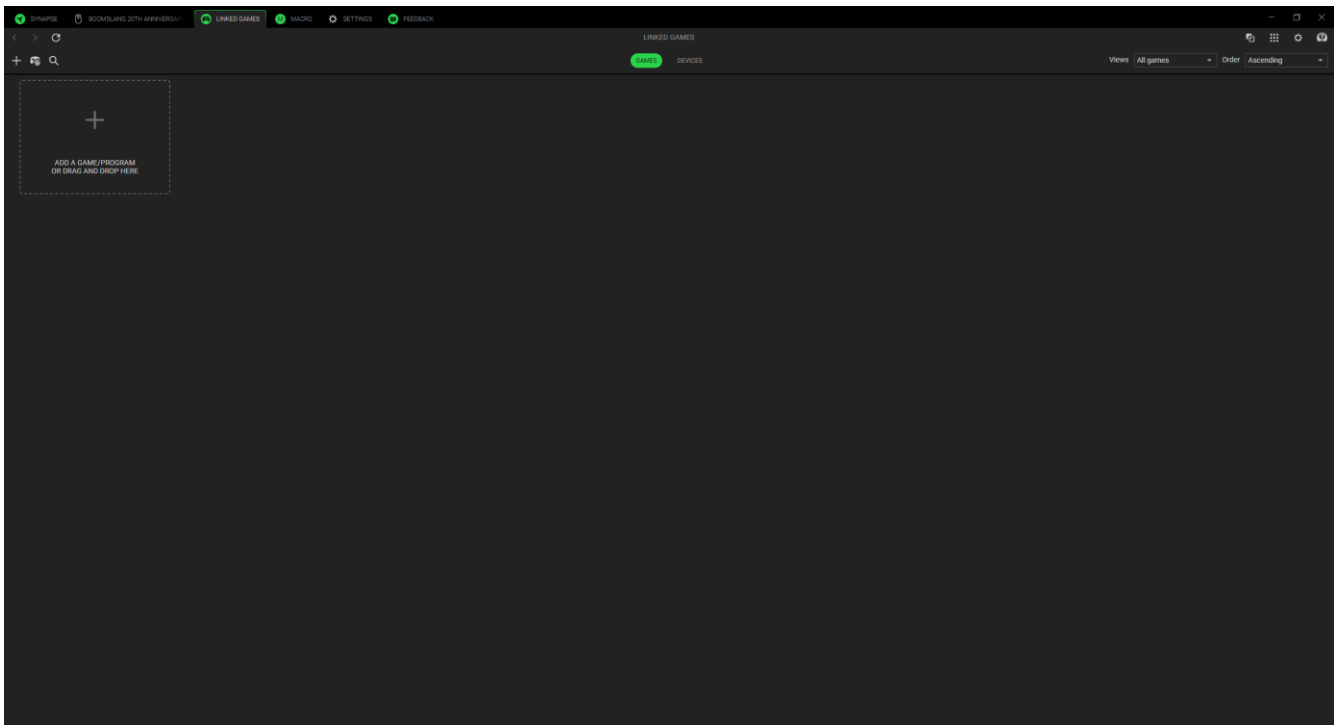

To link an app to your Razer device, click on it from the list and select a device and its profile. This will automatically set your device to the selected profile whenever you launch the app.

## Devices

The Devices subtab lets you view your peripherals and determine which apps are linked to them. By selecting a device, you can see a list of linked apps, add new apps, or remove linked apps. You can filter these apps by using the Views and Order dropdown list. To add an app not listed on your peripheral, you can drag and drop the executable file inside the box or use the Add button ( + ) to open the search window. While inside the search window, you can click the Refresh button ( ↻ ) to rescan installed apps, the Search button ( 🔍 ) to look for a specific game or program from the list, or the Browse link to search for the app manually.

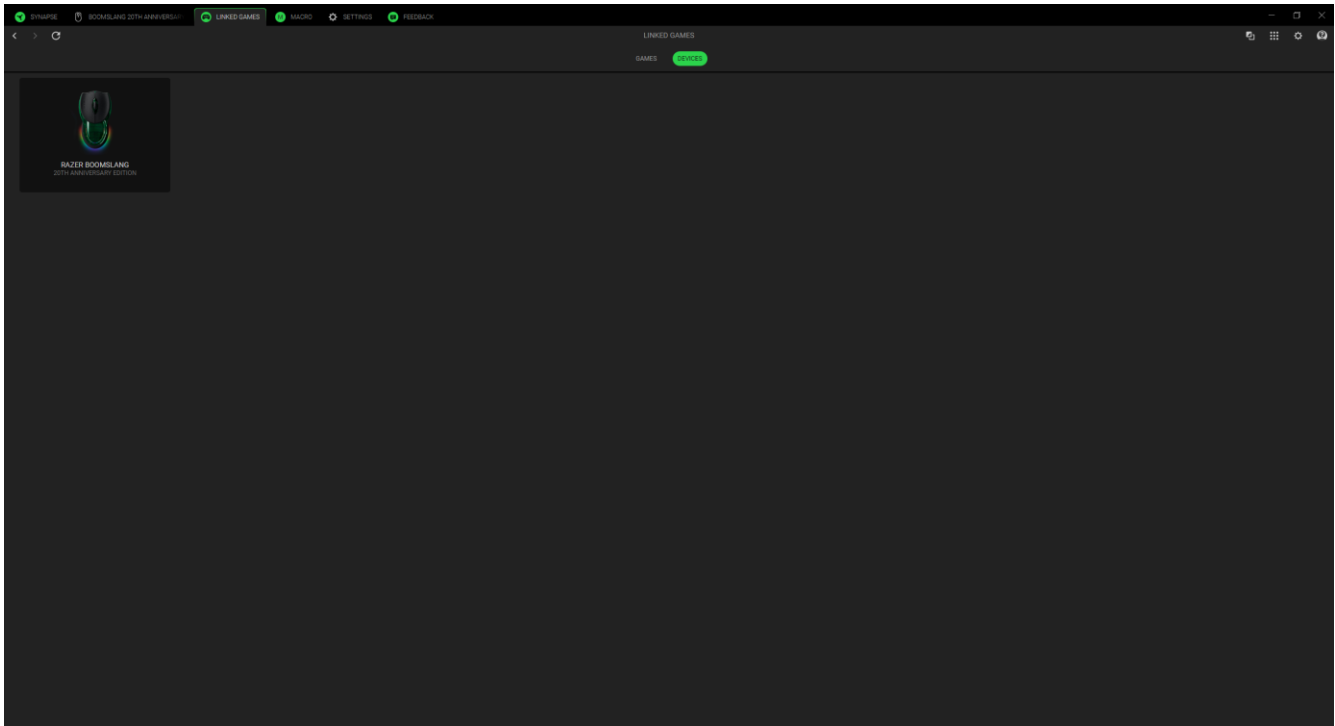

To link an app to your Razer device, click the tick box at the top left corner of the app while inside the search box. This will automatically set your device to the selected profile whenever you launch the app.

# MACRO

If you need to execute a series of complex commands accurately, you need a macro. A macro is a set of recorded keystrokes, button presses, and cursor movements. that you can bind to your device and execute at any time.

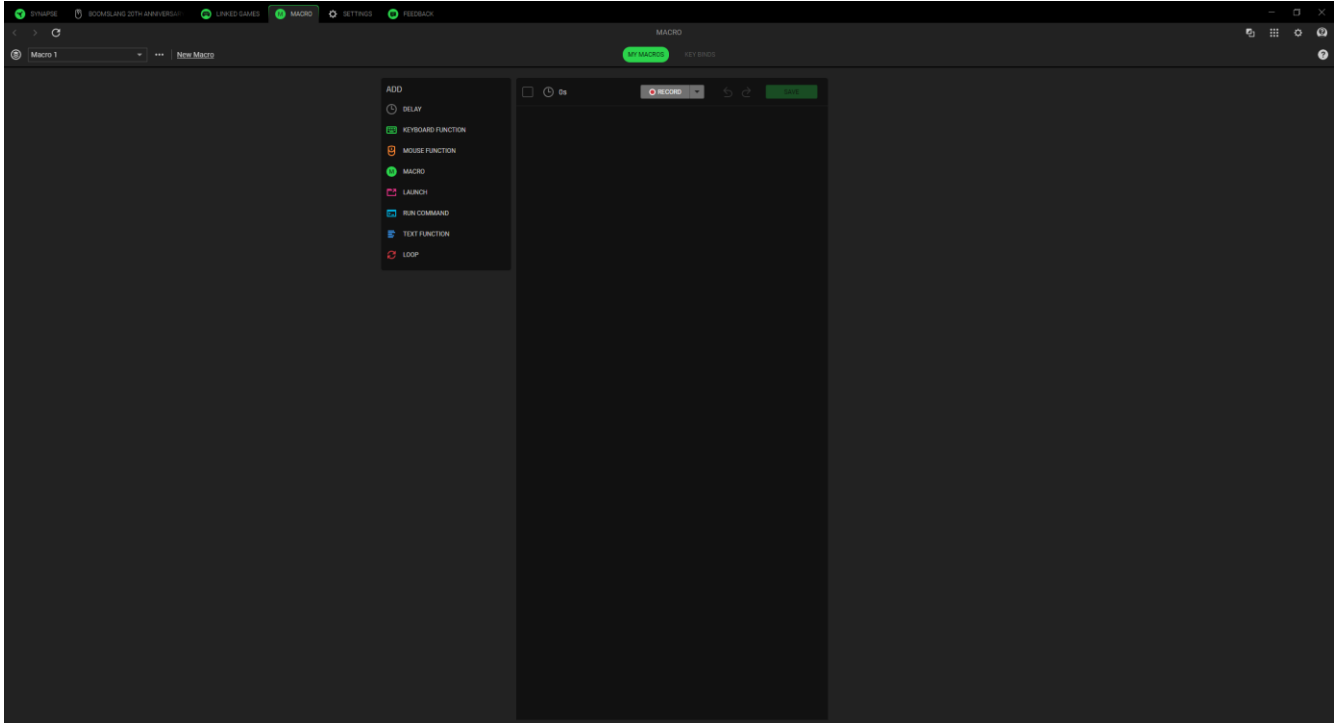

## My Macros

The My Macros subtab allows you to create, edit, and organize these macros to assign them to your Razer device's keys or buttons. Use the following buttons below to access your macro options:

Macro Dropdown Bar



Clicking this dropdown bar will display all the macros for this device. From here, you can search for a specific macro, sort your macros, create a new folder, and create a new macro. Selecting a macro will enable miscellaneous options such as renaming, duplicating, or deleting the macro.

... Miscellaneous

Clicking this button will open a pop-up with options related to your current macro.

New Macro

Use this link to create and select the new macro quickly.

Once you have a macro, you can record keystrokes, button presses, and cursor movements. by clicking the Record button (  ) or you can customize the macro by clicking the dropdown menu button (  ) before you start recording with the following options below:

- **Start Delay.** Set a short delay between 1 and 5 seconds before the recording starts.
- **Shortcut Key.** Assign a shortcut key to start a macro recording even when Razer Synapse is in the background.
- **Delay Settings.** Set the amount of time between each command.
- **Mouse Movement Tracking.** Enable mouse movement recording and set conditions for how it is recorded.

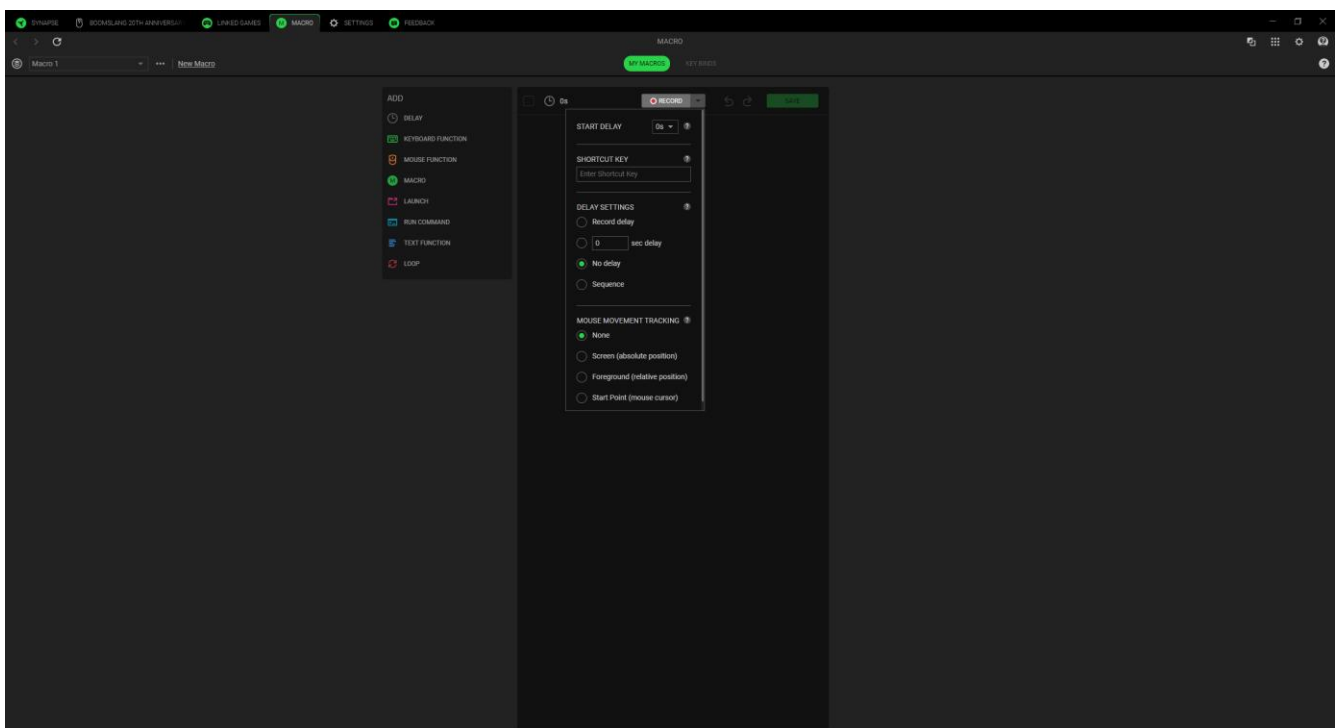

After recording your macro commands, click the Stop button (  ) or press the Shortcut key to end the session. Once you have recorded a macro, you may edit the commands you have entered by selecting each command on the macro screen. Each keystroke or button press is arranged sequentially, with the first command at the top of the screen.

The Insert menu on the left side of the screen allows you to add delays, input keystrokes and button presses, insert an entire macro group within the macro, launch apps, run commands, type texts, and loop a set of commands within the macro.

## Key Binds

The Key Binds subtab allows you to view the Shortcut Keys for the selected macro. You can bind a macro to the key or button of your choice without leaving the Macro tab by clicking the Assign Macro To Your Devices button ( + ).

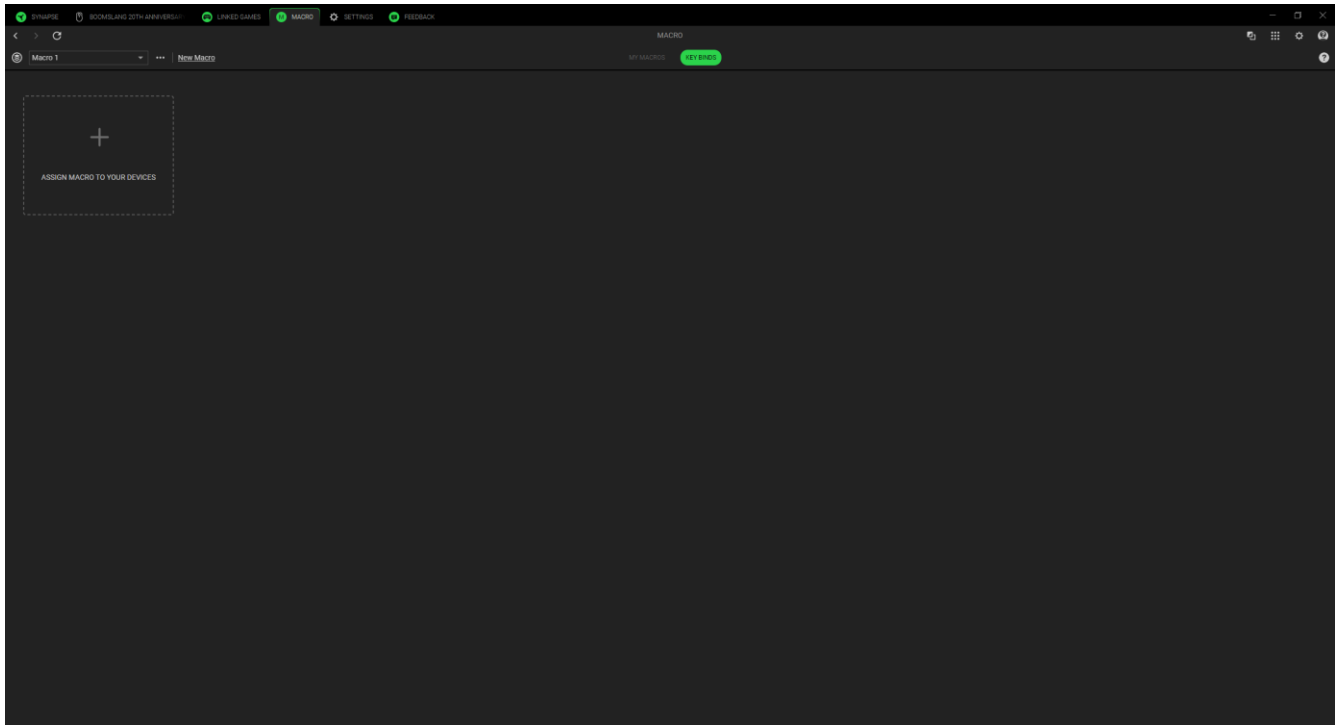

## SETTINGS

The Settings tab, accessible by clicking the Settings button (⚙️), enables you to configure numerous options as listed below:

### Synapse

The Synapse subtab is where you can find options that are specific to the app.

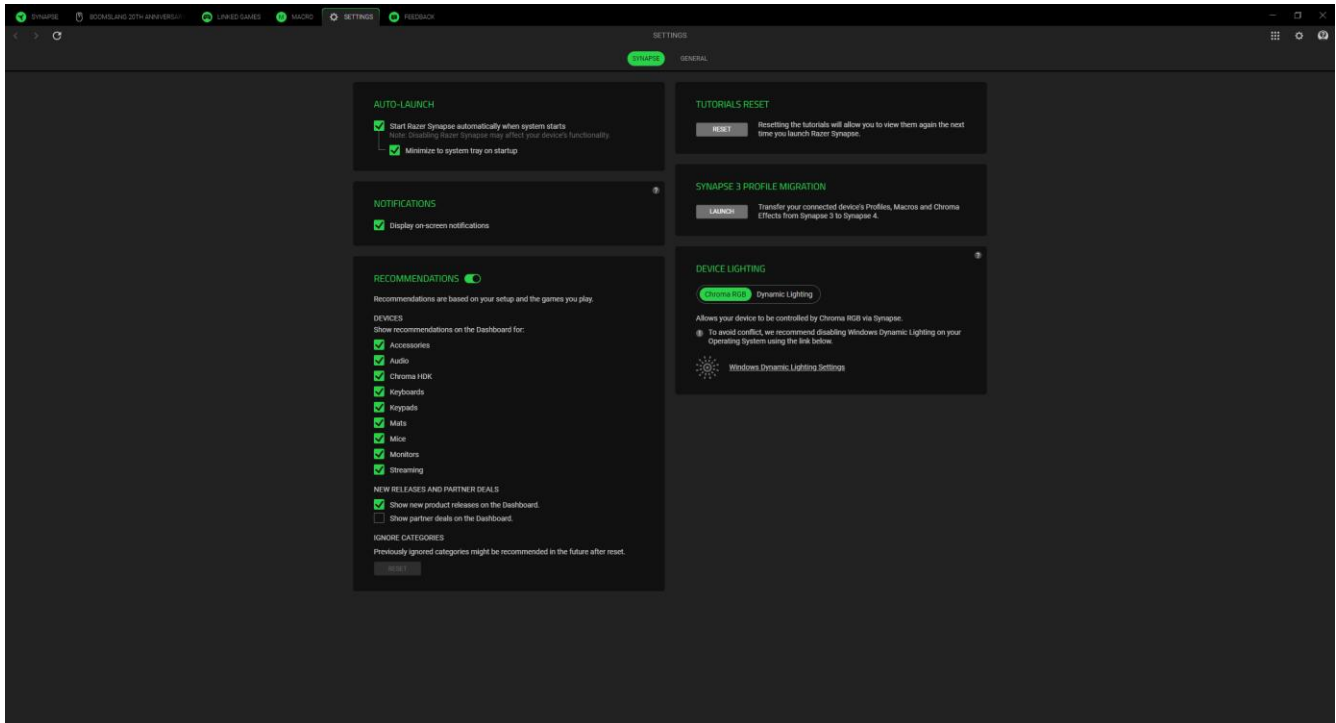

### Auto Launch

The Auto Launch option allows you to configure the startup behavior the app.

### Notifications

The Notifications option allows the app to display on-screen notifications even if you run full-screen apps.

### Recommendations

Recommendations enable us to show the latest products and features on your Dashboard based on your installed devices and linked games.

### Tutorials Reset

Selecting the Reset button will reactivate all tutorials that help you acquaint yourself with Razer Synapse's features.

### *Synapse 3 Profile Migration*

This function lets you transfer all your device's Profiles, Macros, and Chroma Effects from Synapse 3 to the new Synapse.

### *Device Lighting*

This option lets you choose which app will control the lighting effects on your device.

## **General**

The General subtab is the section where you can access miscellaneous options for your app, as well as find additional information about the software.

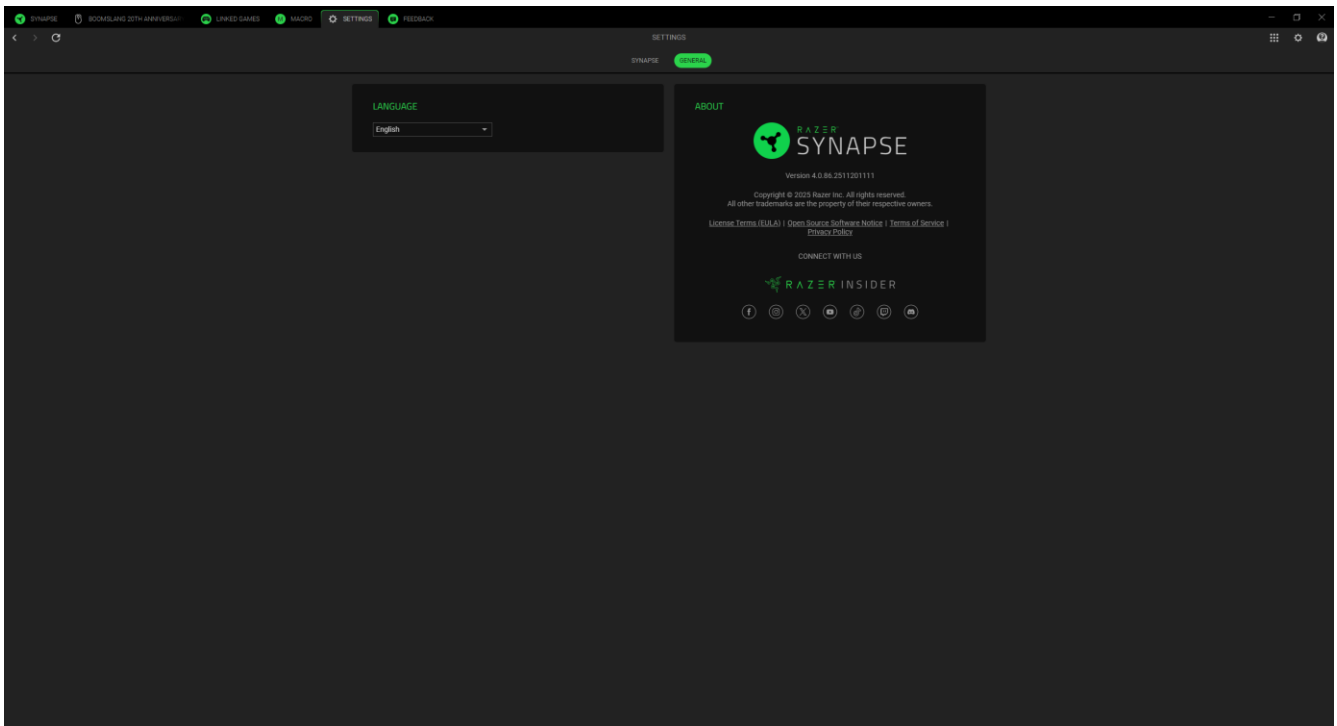

### *Language*

This option lets you change the display language of Razer Synapse.

### *About*

The About section shows the current software version, displays the copyright statement, and provides relevant links for Razer's terms of use. You may also use this option to access Razer's social communities quickly.

# FEEDBACK

Help us improve Razer Synapse by giving your comments, suggestions, and problems with the software. You can contact us directly using this tab and even earn rewards for reporting bugs.

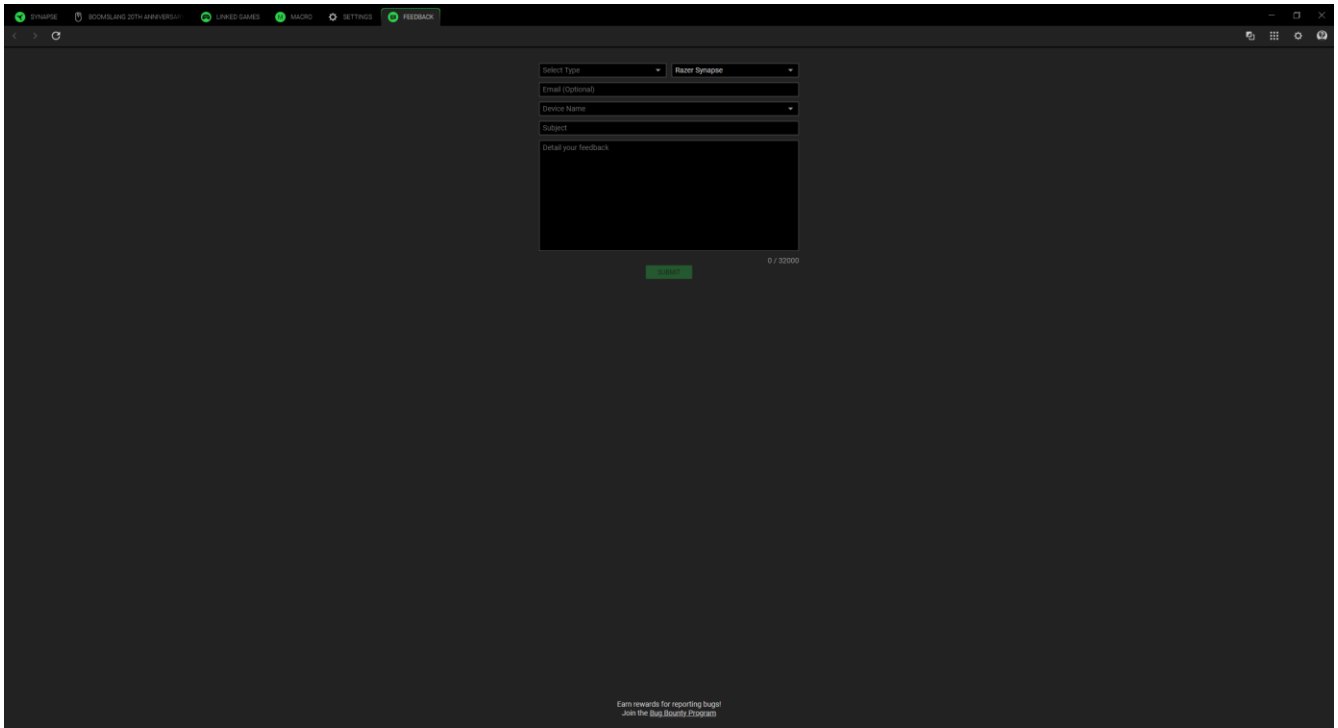

---

## 6. SAFETY AND MAINTENANCE

### SAFETY GUIDELINES

To achieve maximum safety while using your Razer Boomslang 20th Anniversary Edition, we suggest that you adopt the following guidelines:

Should you have trouble operating the device properly and troubleshooting does not work, unplug the device and contact the Razer hotline or go to [support.razer.com](https://support.razer.com) for assistance.

Keep the mouse's accessories out of the reach of small children to avoid accidents and/or injuries.

Don't take apart the device, and don't attempt to operate it under abnormal current loads. Doing so will void your warranty.

Keep the device away from liquid, humidity, or moisture. Operate the device only within the specific temperature range of 0°C (32°F) to 40°C (104°F). Should the temperature exceed this range, unplug and/or switch off the device to stabilize the temperature to an optimal level.

### COMFORT

Research has shown that long periods of repetitive motion, improper positioning of your computer peripherals, incorrect body position, and poor habits may be associated with physical discomfort and injury to nerves, tendons, and muscles. Below are some guidelines to avoid injury and ensure optimum comfort while using your Razer Boomslang 20th Anniversary Edition.

- Position your keyboard and monitor directly in front of you with your mouse next to it. Place your elbows next to your side, not too far away, and your keyboard within easy reach.
- Adjust the height of your chair and table so that the keyboard and mouse are at or below elbow-height.
- Keep your feet well supported, posture straight, and your shoulders relaxed.
- During gameplay, relax your wrist and keep it straight. If you do the same tasks with your hands repeatedly, try not to bend, extend or twist your hands for long periods.
- Don't rest your wrists on hard surfaces for long periods. Use a wrist rest to support your wrist while gaming.
- Don't sit in the same position all day. Get up, step away from your desk and do exercises to stretch your arms, shoulders, neck, and legs.

If you experience any physical discomfort while using your mouse, such as pain, numbness, or tingling in your hands, wrists, elbows, shoulders, neck, or back, please consult a qualified medical doctor immediately.

## **MAINTENANCE AND USE**

The Razer Boomslang 20th Anniversary Edition requires minimum maintenance to keep it in optimum condition. Once a month, we recommend you unplug the device from the computer and clean it using a soft cloth or cotton swab to prevent dirt buildup. Don't use soap or harsh cleaning agents.

To get the ultimate experience in movement and control, we highly recommend a premium mouse mat from Razer. Some surfaces will cause undue wear on the feet requiring constant care and eventual replacement.

Do note that the Razer Boomslang 20th Anniversary Edition's sensor is 'tuned' or optimized specially for the Razer mouse mats. This means that the sensor has been tested extensively to confirm that the Razer Boomslang 20th Anniversary Edition reads and tracks best on Razer mouse mats.

## **BATTERY WARNING**

The Razer Boomslang 20th Anniversary Edition contains a Li-ion rechargeable battery. In general, the life expectancy of such batteries is dependent upon usage. If you suspect that the Li-ion rechargeable battery inside the Razer Boomslang 20th Anniversary Edition may be drained (has a low charge), try charging it.

**Caution:** Don't open, mutilate, or expose to conducting materials (metal), moisture, liquid, fire, or heat. Doing so may cause batteries to leak or explode, resulting in personal injury. Battery life varies with usage.

---

## 7. LEGALESE

### **COPYRIGHT AND INTELLECTUAL PROPERTY INFORMATION**

©2026 Razer Inc. All rights reserved. Razer, the triple-headed snake logo, Razer logo, "For Gamers. By Gamers.", and "Powered by Razer Chroma" logo are trademarks or registered trademarks of Razer Inc. and/or affiliated companies in the United States or other countries. All other trademarks are the property of their respective owners.

Windows and the Windows logo are trademarks of the Microsoft group of companies.

Razer Inc. ("Razer") may have copyright, trademarks, trade secrets, patents, patent applications, or other intellectual property rights (whether registered or unregistered) concerning the product in this guide. Furnishing of this guide does not give you a license to any such copyright, trademark, patent or other intellectual property right. The Razer Boomslang 20th Anniversary Edition (the "Product") may differ from pictures whether on packaging or otherwise. Razer assumes no responsibility for such differences or for any errors that may appear. Information contained herein is subject to change without notice.

### **LIMITED PRODUCT WARRANTY**

For the latest and current terms of the Limited Product Warranty, please visit [razer.com/warranty](https://www.razer.com/warranty).

### **LIMITATION OF LIABILITY**

Razer shall in no event be liable for any lost profits, loss of information or data, special, incidental, indirect, punitive or consequential or incidental damages, arising in any way out of distribution of, sale of, resale of, use of, or inability to use the Product. In no event shall Razer's liability exceed the retail purchase price of the Product.

### **GENERAL**

These terms shall be governed by and construed under the laws of the jurisdiction in which the Product was purchased. If any term herein is held to be invalid or unenforceable, then such term (in so far as it is invalid or unenforceable) shall be given no effect and deemed to be excluded without invalidating any of the remaining terms. Razer reserves the right to amend any term at any time without notice.