



RAZER HANDHELD DOCK CHROMA

MASTER GUIDE

Set the ultimate stage for your gaming handheld or tablet with the **Razer Handheld Dock Chroma**. Featuring a fully loaded 6-port design that supports USB A, USB C, HDMI, and Ethernet, keep your device charged, show it off, and expand your reality of what handheld gaming can be.

CONTENTS

1. WHAT'S INSIDE.....	3
2. WHAT'S NEEDED	4
3. LET'S GET YOU COVERED	4
4. TECHNICAL SPECIFICATIONS	6
5. SETTING UP YOUR RAZER HANDHELD DOCK CHROMA	7
6. CONFIGURING YOUR RAZER HANDHELD DOCK CHROMA.....	10
7. SAFETY AND MAINTENANCE	23
8. LEGALESE.....	24

1. WHAT'S INSIDE

- Razer Handheld Dock Chroma

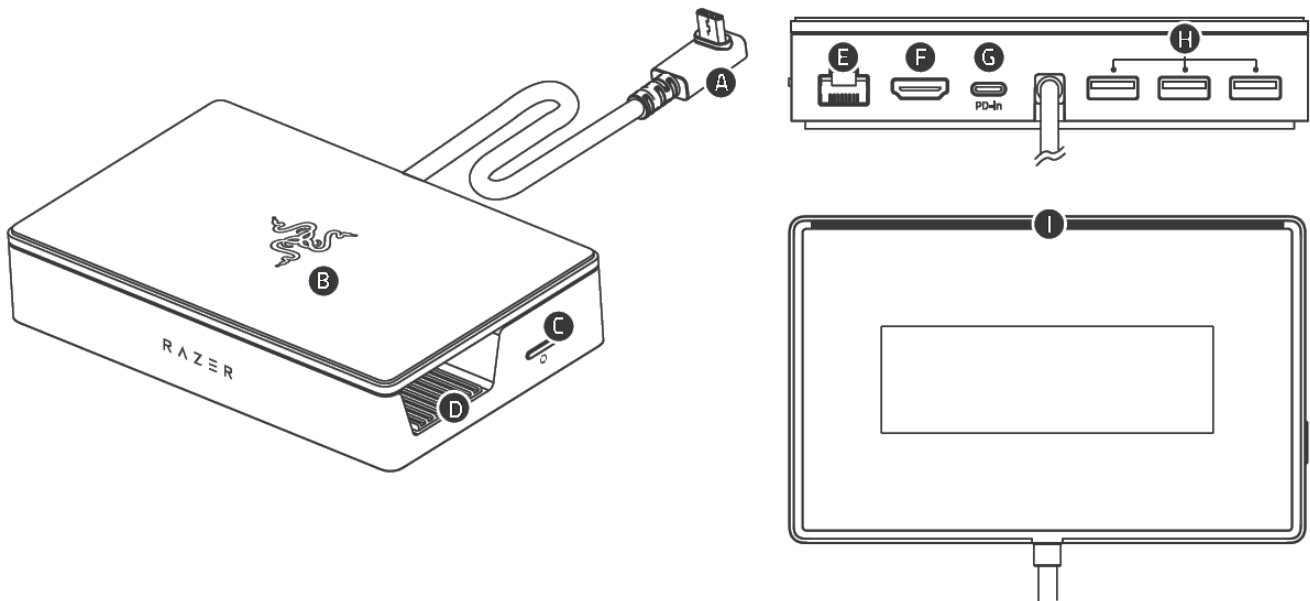

- A. USB 3.2 Type C connector*
- B. Adjustable stand/cover
- C. Chroma RGB button
- D. Anti-slip docking bay
- E. Gigabit Ethernet (RJ-45) port
- F. HDMI™ port (supports 4k@60Hz)
- G. USB Type C Power Delivery (PD) input port**
- H. 3x USB 3.2 Gen 1 Type A ports
- I. LED backlight Powered by Razer Chroma™ RGB

- Important Product Information Guide

**Supports up to 85W output*

***Supports up to 100W input*

2. WHAT'S NEEDED

PRODUCT REQUIREMENTS

- Mobile gaming devices with a USB Type C port

RAZER SYNAPSE REQUIREMENTS

- Windows® 10 64-bit (or higher)
- Internet connection for software installation



i Full compatibility list available here: rZR.to/handheld-dock-chroma

3. LET'S GET YOU COVERED

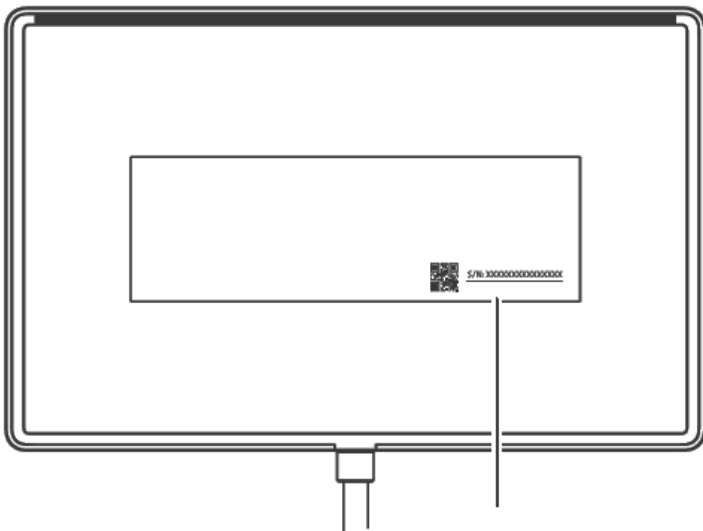



Register your product and score exclusive benefits
razerid.razer.com/warranty

4. TECHNICAL SPECIFICATIONS

FEATURES

Connection Type	USB C
	USB C (Input) – 100W PD
Input & Output	3x USB A Gen 1 (5 Gbps)
	1x GbE
Video Output	HDMI 2.0
Adjustable Viewing Angle	2 Stages (45° / 75°)
Razer Chroma RGB	Yes
Material	Aluminum & Plastic

5. SETTING UP YOUR RAZER HANDHELD DOCK CHROMA

CONNECT YOUR DEVICE

1.

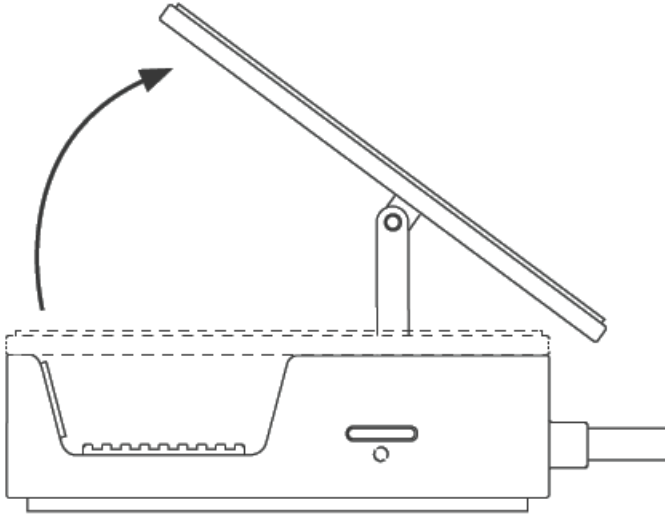

2.

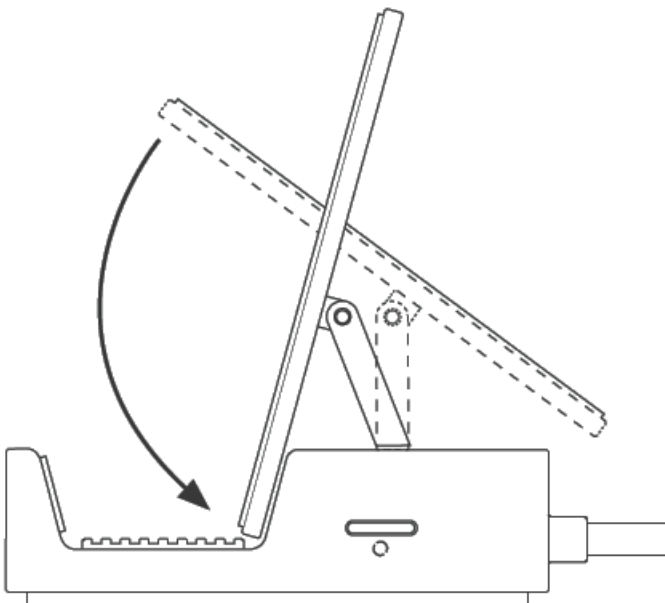

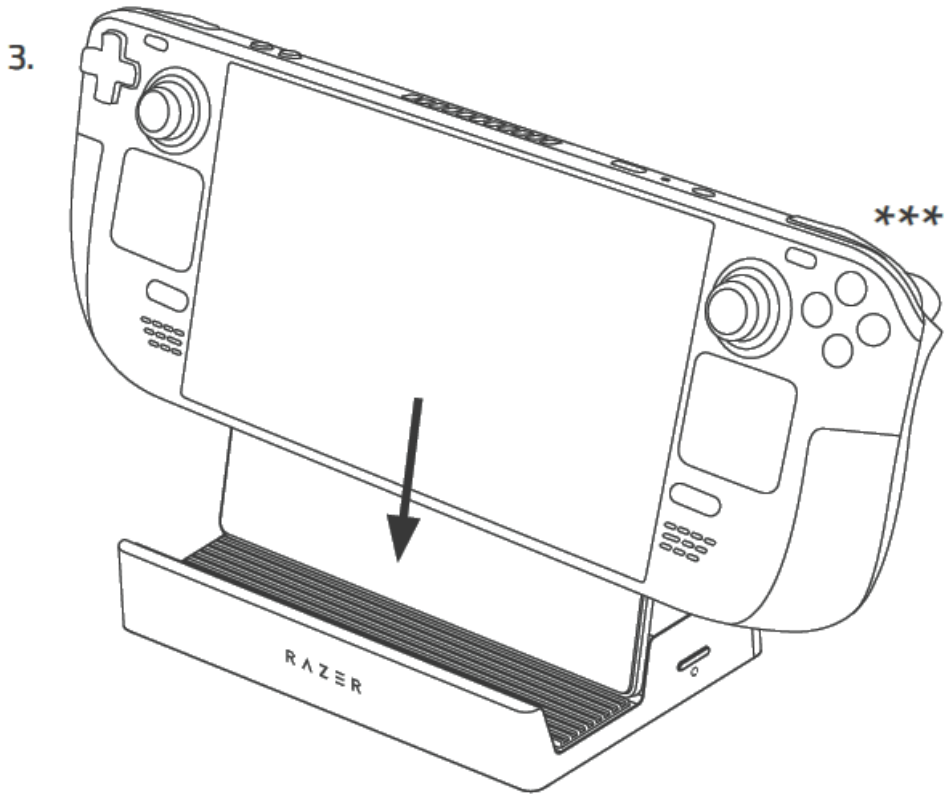

****Not included*

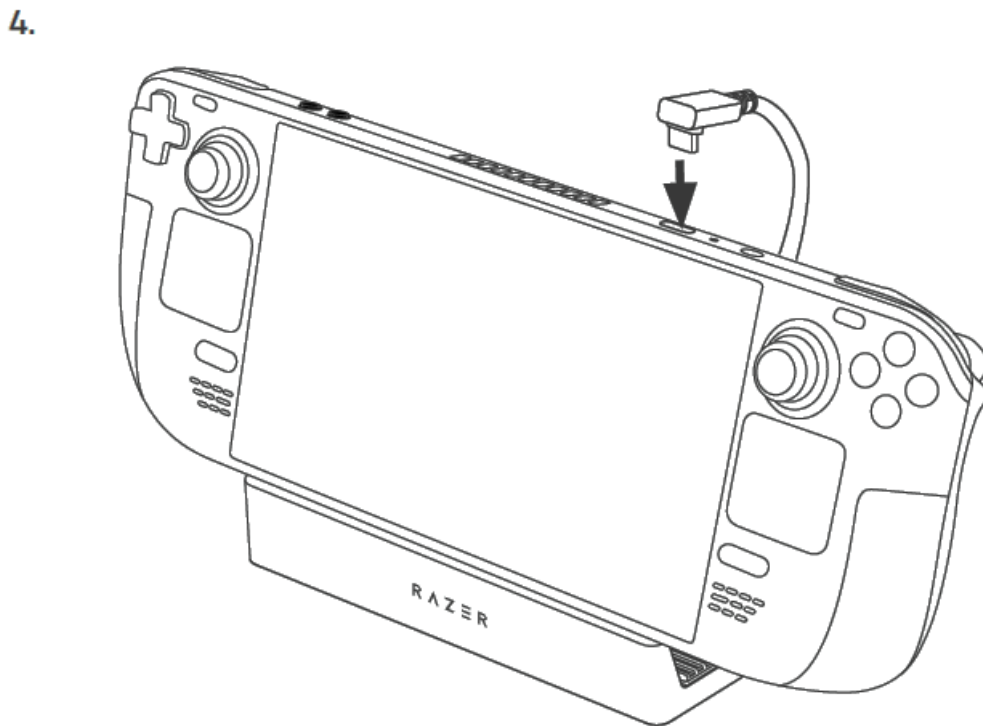

Install Razer Synapse when prompted or download the installer from [razer.com/synapse](https://www.razer.com/synapse).



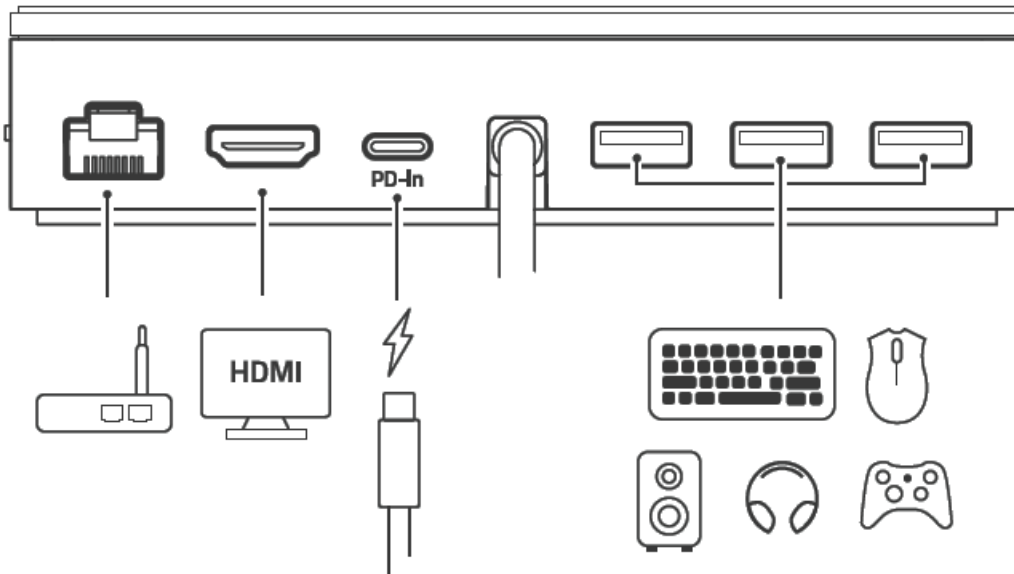

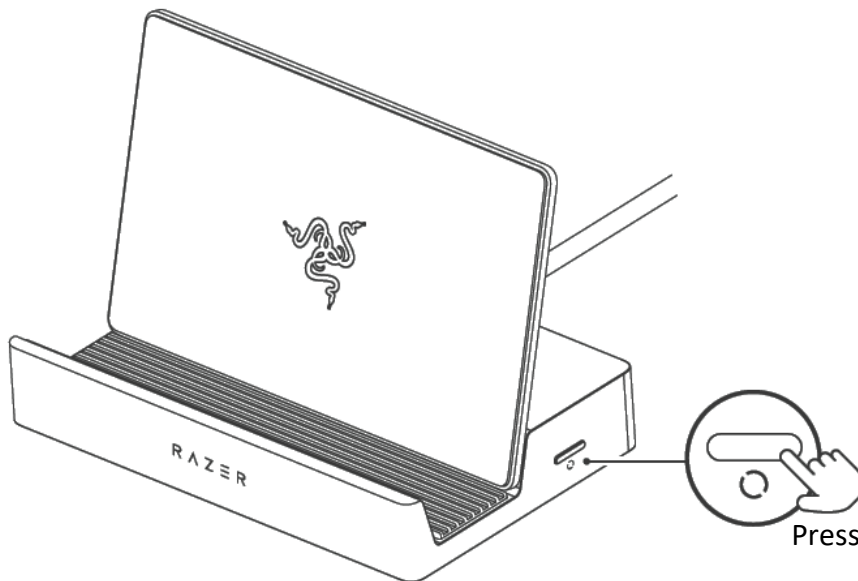

ADD OPTIONAL ACCESSORIES



PERSONALIZE THE LED BACKLIGHT



Chroma Effects List

	Breathing
	Fire
	Spectrum Cycling
	Starlight
	Static
	Wave

Use the Razer Synapse app to customize your device's lighting further.

Find out more about your gaming-grade mobile accessory at support.razer.com

6. CONFIGURING YOUR RAZER HANDHELD DOCK CHROMA

 *Disclaimer: This guide provides an overview of the New Razer Synapse app and may only partially cover some of the features of your device. The New Razer Synapse requires an Internet connection to install, update, access, and save cloud-based features. Registering for a Razer ID account is recommended but optional. All features listed here are subject to change based on the current version, connected device(s), and supported add-ons.*

SYNAPSE

The Synapse tab is your default tab when you first launch Razer Synapse. Use the following buttons below to navigate the user interface:

— Minimize

Clicking this button will minimize the app to the taskbar while it runs in the background.

□ Maximize

This button expands the browser window to fill the entire screen. To restore the window to its original size, click the maximize button again.

× Close

This button will close all relevant tabs and terminate the application completely.

< Previous Tab

Clicking this button will return you to the last tab you have visited.

> Next Tab

Clicking this button will move you to the next page if you've recently used the Previous Tab button.

↻ Refresh Tab

This button reloads the current page. Use this if a page isn't displaying correctly or you want to see the latest content.

⬇ Download Update

If this button appears, that means there are changes to the app. Use this if a page isn't displaying correctly or you want to see the latest content.

 More

Clicking this button will open a pop-up so you can easily access your Devices, Modules, and Other Installed Apps tabs.

 Settings

Clicking this button will open the Settings tab, so you can quickly change the settings to this app.

 Profile

This button will open a pop-up to access the Log In, Feedback, Rate This Software, Add WiFi Device, and Exit options.

 Info

Hovering over this button will pop up an additional information about a feature or function.

Dashboard

The Dashboard subtab is an overview of your Razer Synapse, where you can access all your Razer devices, modules, and online services.

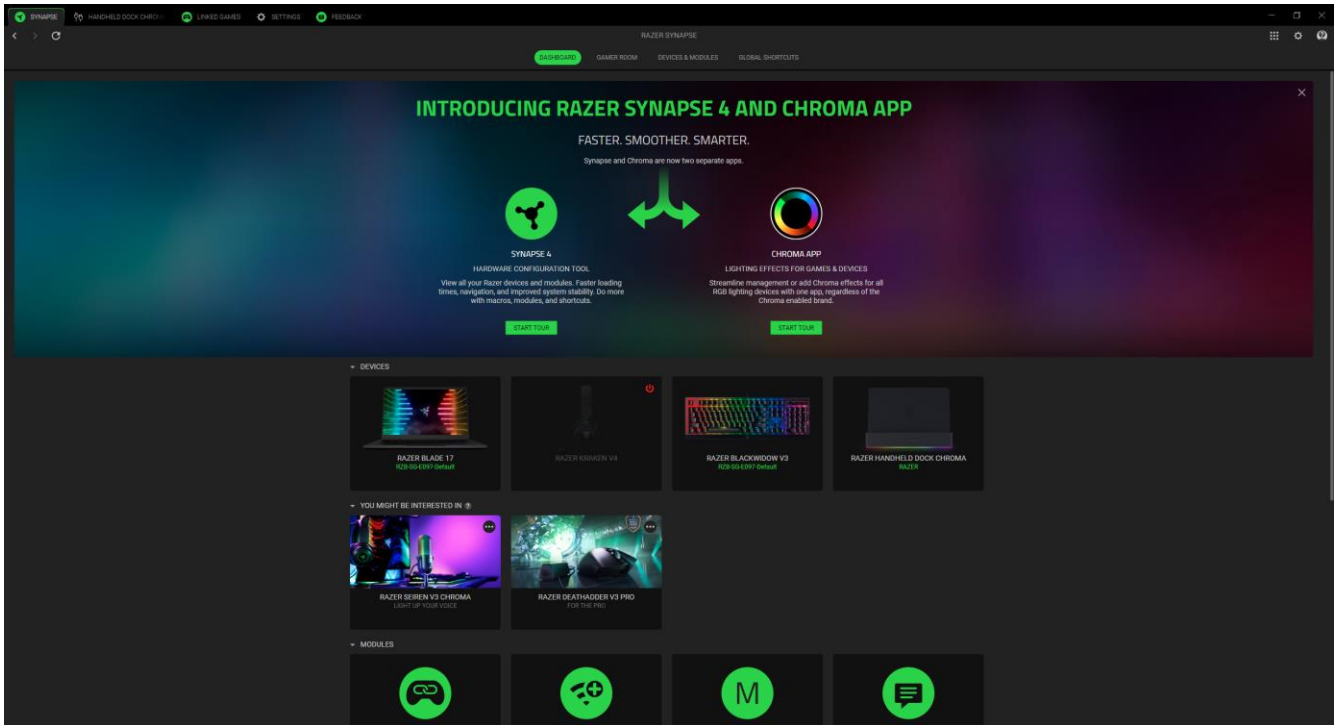

Gamer Room

The Gamer Room subtab shows all devices with the Razer Aether Light feature. From here, you can view and manage your Gamer Room-supported devices.

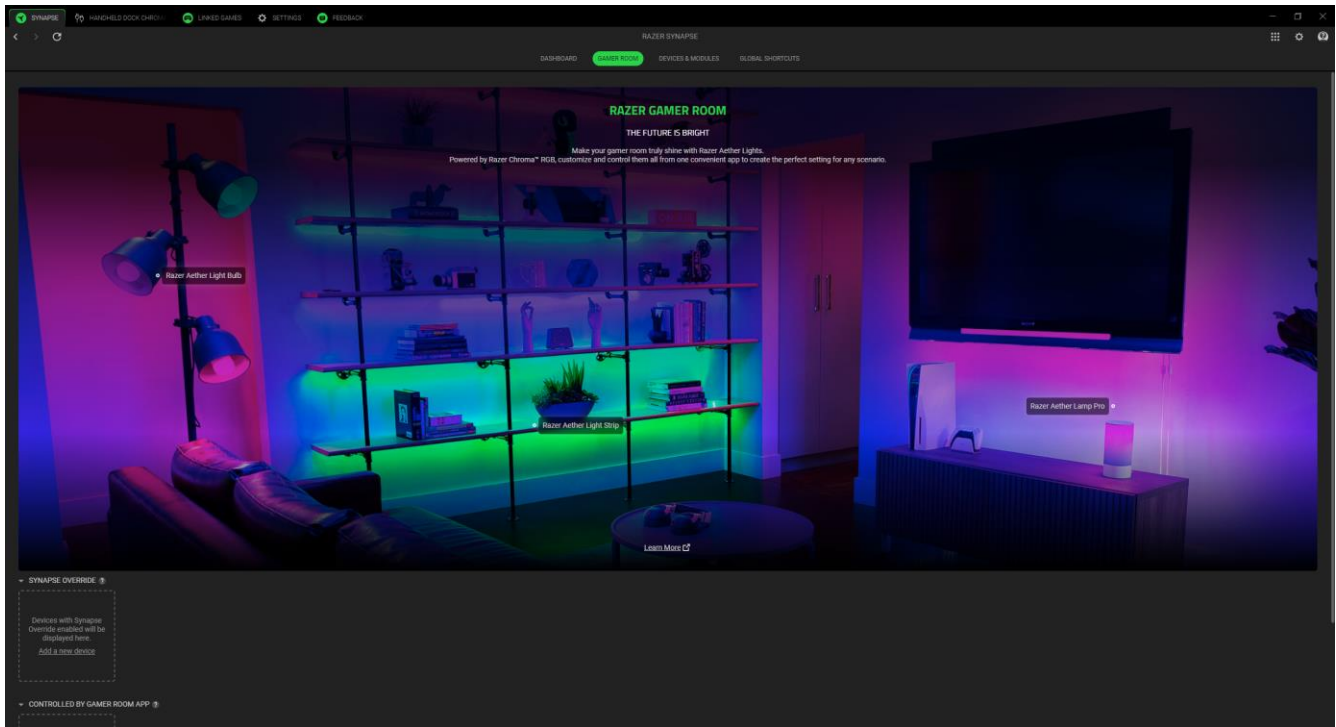

Synapse Override

This section allows you to select and customize your device's lighting and make it react to Chroma-enabled games and Chroma Connect apps using Razer Synapse.

Controlled By Gamer Room App

This section displays all supported devices controlled remotely by the Gamer Room app.

Devices & Modules

The Devices & Modules subtab displays all installed, recently updated, and available modules for installation.

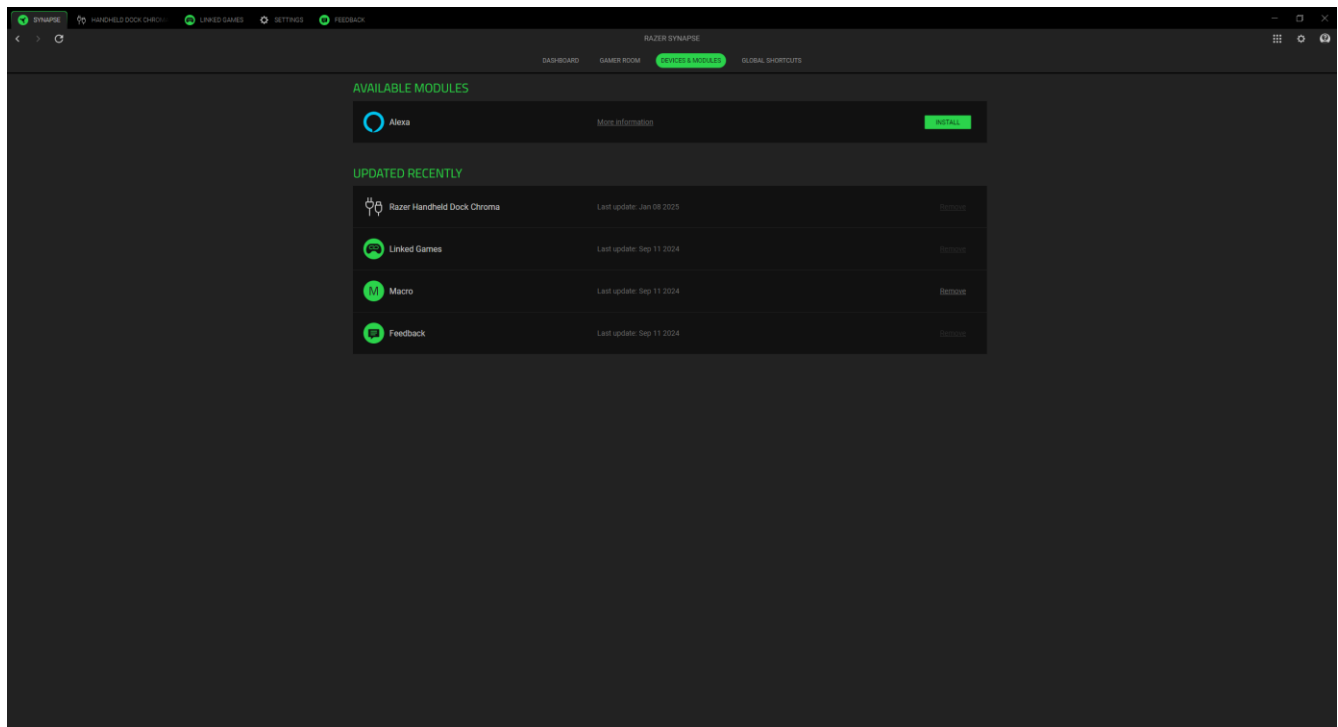

Global Shortcuts

Bind operations or Razer Synapse functions to custom key-combinations from any Razer Synapse-enabled device inputs, which apply across all device profiles.

 *Only Razer Synapse-enabled device inputs will be recognized.*

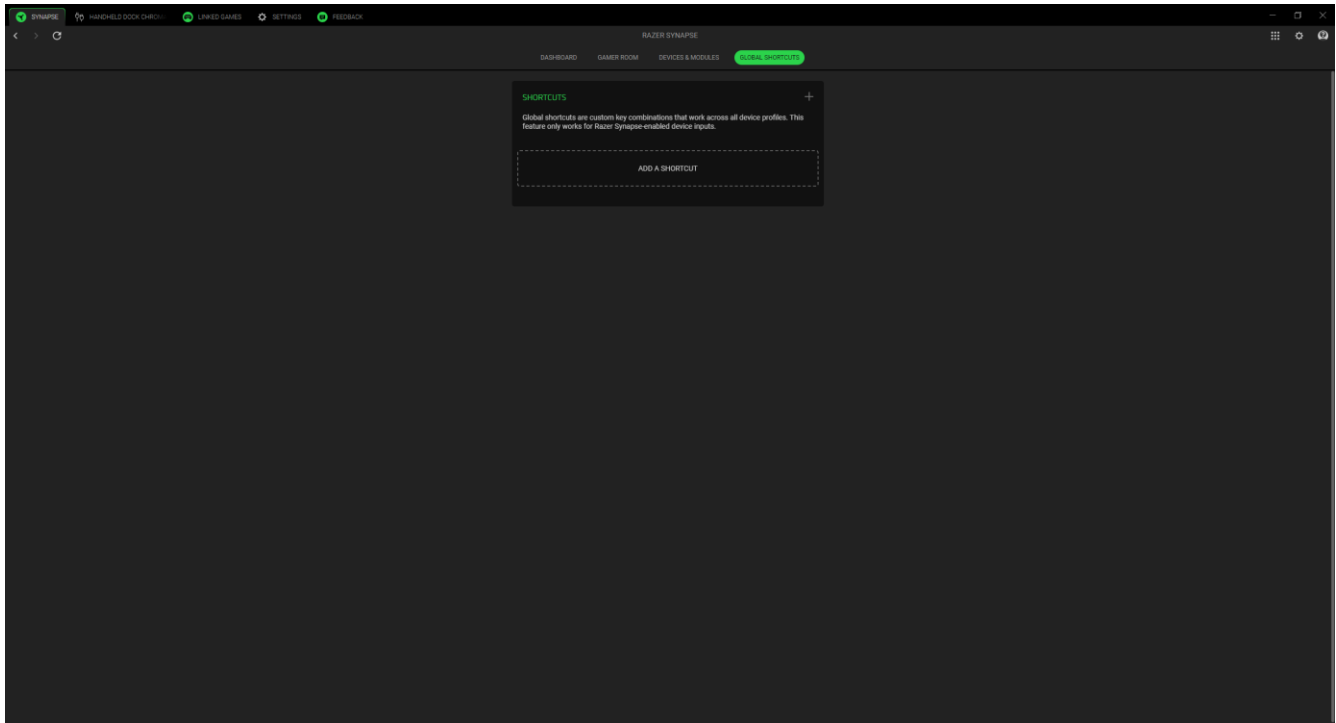

HANDHELD DOCK CHROMA

The Handheld Dock Chroma tab is the main tab for your Razer Handheld Dock Chroma. You can change your device settings from here, such as lighting (if supported), setting and customizing EQ profiles, and adjusting the overall system volume or individual volume of all active applications. Any changes under this tab will be saved automatically to your local system and cloud storage. Use the following buttons below to access your profile options:

▾ Profiles Dropdown Bar

Clicking this dropdown bar will display all the profiles for this device so you can quickly change profiles.

⋮ Miscellaneous

Clicking this button will open a pop-up with options related to your current profile.

Lighting

The Lighting subtab enables you to modify your Razer device's light settings.

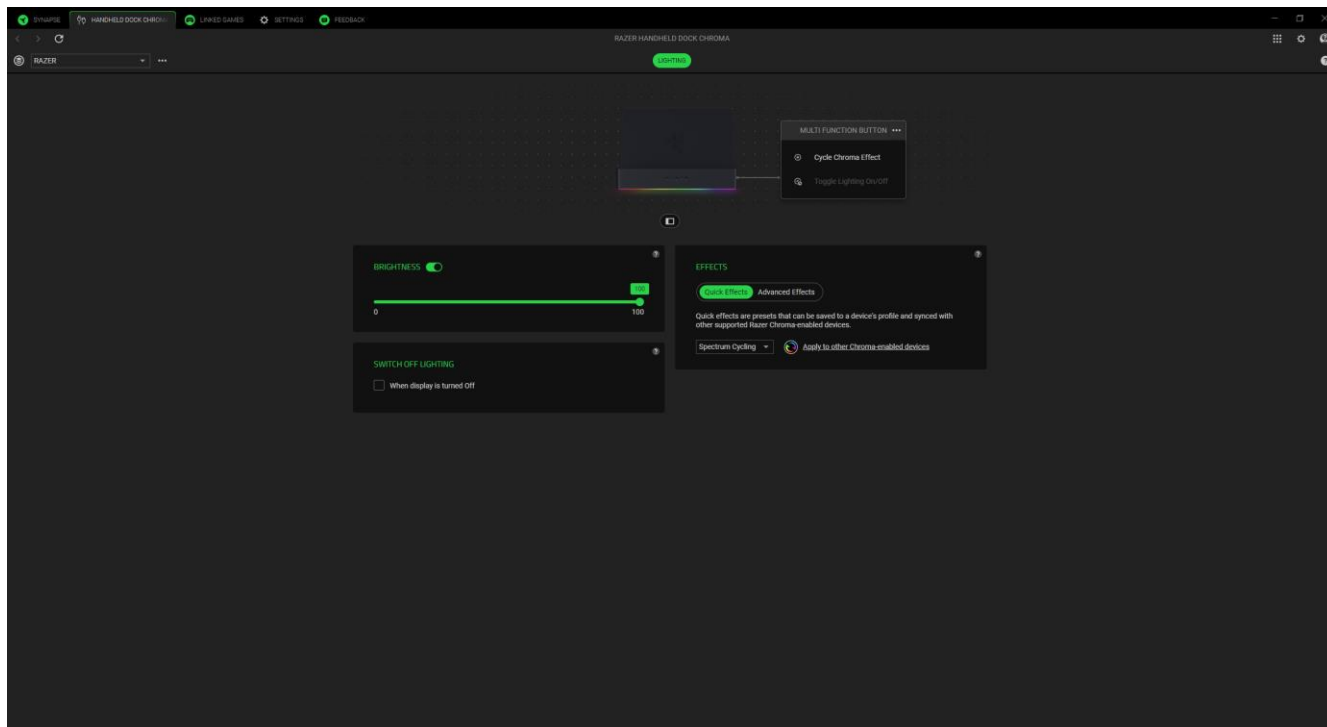

Profile

Profile is a data storage system that keeps all your Razer device settings. By default, the profile name is based on your system's name. Clicking the dropdown bar (▾) will display all profiles for this device







so you can quickly switch between them. To add, import, rename, duplicate, export, or delete a profile, press the profile's corresponding Miscellaneous button (⋮).

Brightness

You can turn off your Razer device's lighting by toggling the Brightness option or increase/decrease the luminance using the slider.

Quick Effects

A number of quick effects can be selected and applied to your device's lighting, as listed here:

	Name	Description	How to set up
	Audio meter	The device will light up according to the audio level with a default spectrum of colors.	Select a Color Boost level.
	Breathing	The lighting fades in and out of the selected color(s)	Select up to 2 colors or randomize
	Fire	The LEDs light up in warm colors to mimic the motion of flames	No further customization required
	Spectrum cycling	The lighting will cycle between 16.8 million colors indefinitely	No further customization required
	Starlight	Each LED will fade in and out at a random time and duration	Select up to 2 colors or randomize colors and select a duration
	Static	The LEDs will remain lit in the selected color	Select a color
	Wave	The lighting will move in the direction selected with a default spectrum of colors	Select either clockwise or counterclockwise wave direction

If you have other supported Razer Chroma-enabled devices, you can synchronize their quick effects with your Razer device by clicking the Chroma Sync button ().

Advanced Effects



The Advanced Effects option allows you to choose a Chroma Effect Profile you want to use on your Razer Chroma-enabled peripheral. To start making your own Chroma Effect Profile, press the Launch Chroma Studio button ().

 *Some lighting effects listed here may not be available for your device. Only other Razer devices that support the selected lighting effect will synchronize.*

LINKED GAMES

The Linked Games tab allows you to add apps, view peripherals linked to apps, or search for listed apps.

Games

The Games subtab enables you to link apps to your peripherals. You can also sort apps based on alphabetical order, last played, or most played. Apps will still be listed here, even if not linked to a Razer device. To add an app that is not listed on the screen, you can use the Add button () to search for it manually or use the Scan button () to search for it automatically. Click the Search button () to look for a specific game or program from the list.

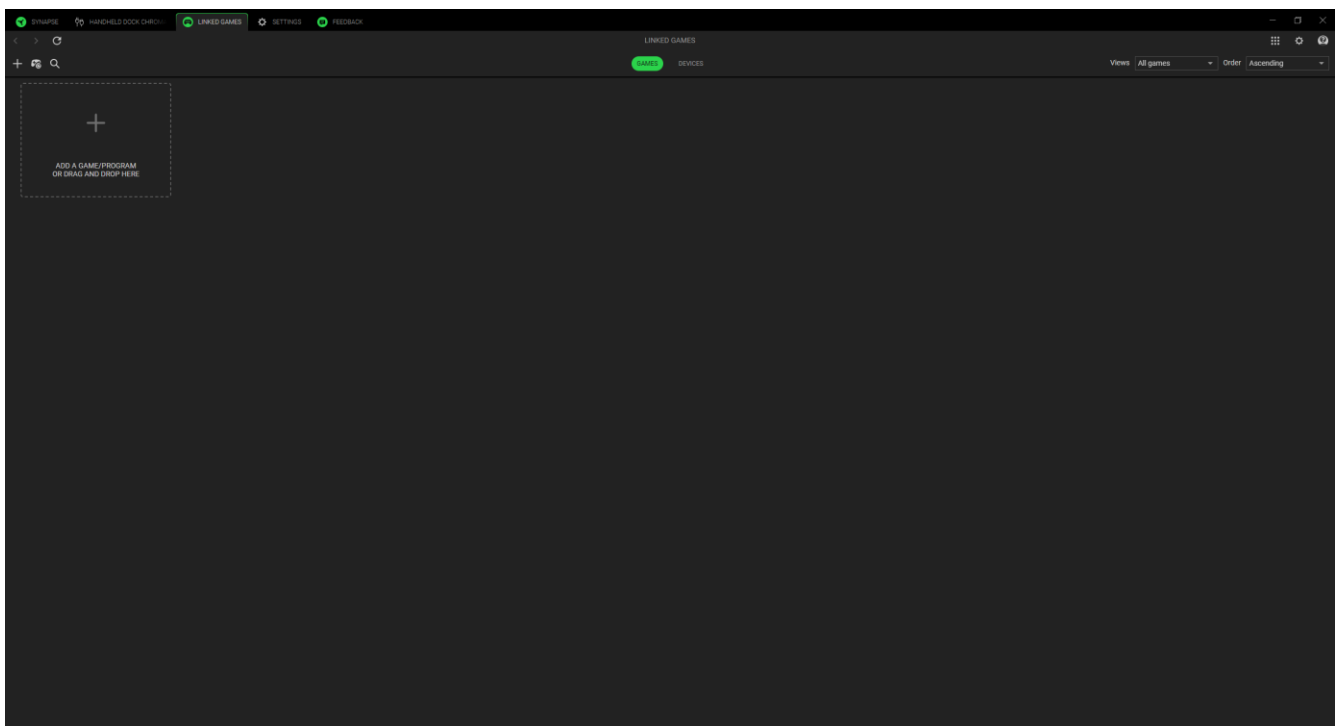

To link an app to your Razer device, click on it from the list and select a device and its profile. This will automatically set your device to the selected profile whenever you launch the app.

Devices

The Devices subtab lets you view your peripherals and determine which apps are linked to them. By selecting a device, you can see a list of linked apps, add new apps, or remove linked apps. You can filter these apps by using the Views and Order dropdown list. To add an app not listed on your peripheral, you can drag and drop the executable file inside the box or use the Add button (+) to open the search window. While inside the search window, you can click the Refresh button (↻) to rescan installed apps, the Search button (🔍) to look for a specific game or program from the list, or the Browse link to search for the app manually.

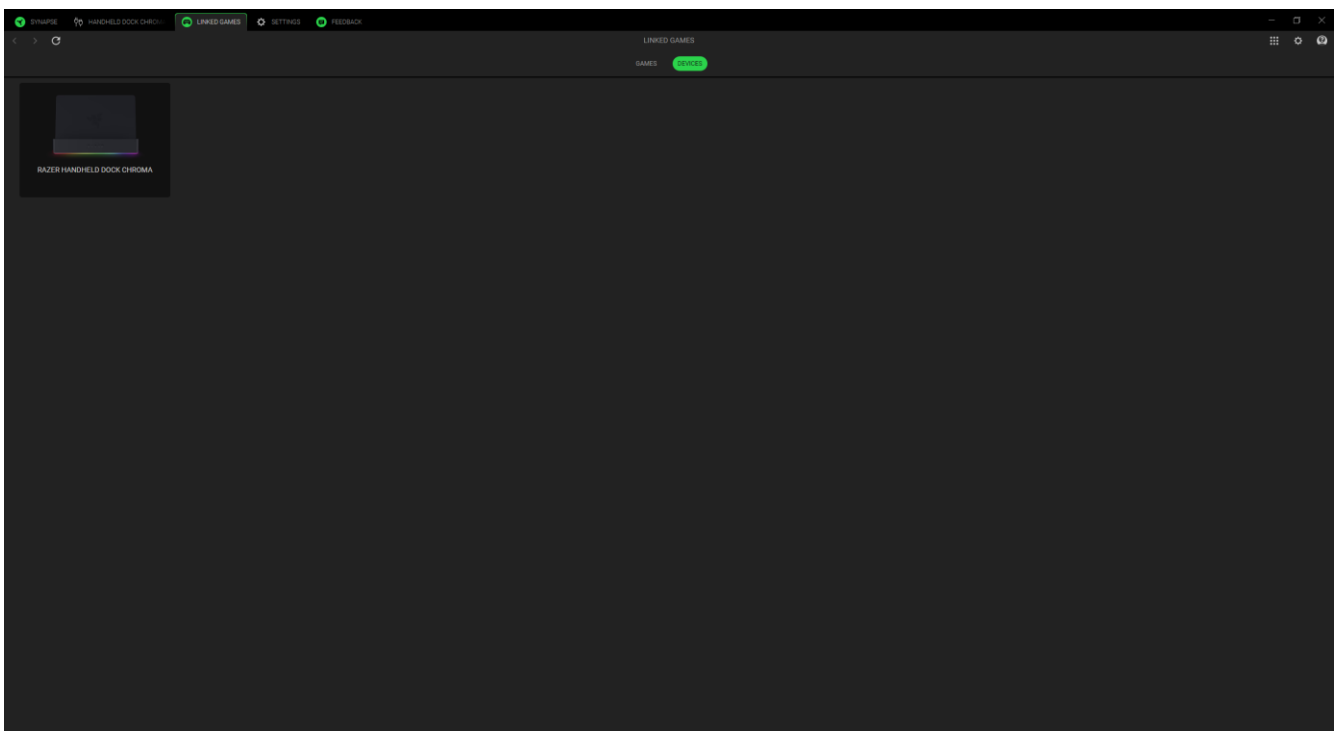

To link an app to your Razer device, click the tick box at the top left corner of the app while inside the search box. This will automatically set your device to the selected profile whenever you launch the app.

SETTINGS

The Settings tab, accessible by clicking the (⚙) button, enables you to configure numerous options as listed below:

Synapse

The Synapse subtab is where you can find options that are specific to the app.

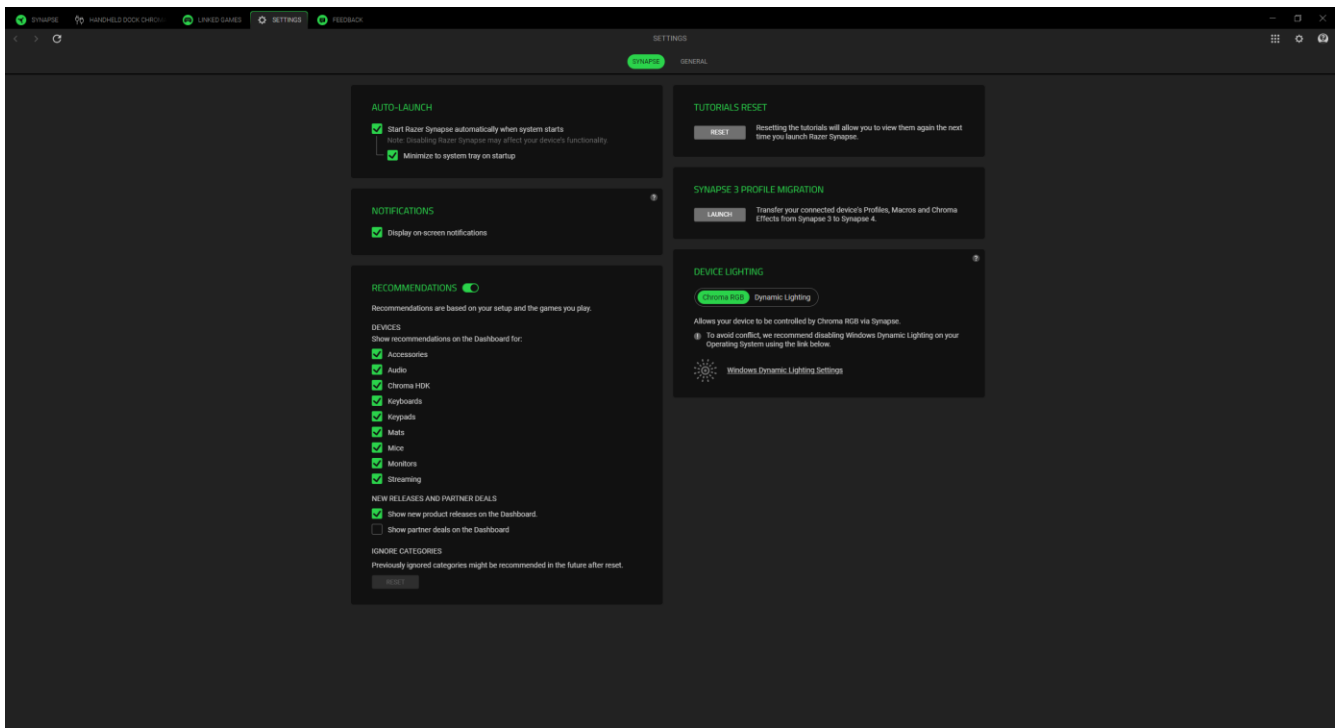

Auto Launch

The Auto Launch option allows you to configure the startup behavior the app.

Notifications

The Notifications option allows the app to display on-screen notifications even if you run full-screen apps.

Recommendations

Recommendations enable us to show the latest products and features on your Dashboard based on your installed devices and linked games.

Tutorials Reset

Selecting the Reset button will reactivate all tutorials that help you acquaint yourself with Razer Synapse's features.

Profile Migration

This function lets you transfer all your device's Profiles, Macros, and Chroma Effects from Synapse 3 to the new Synapse.

Device Lighting

This option lets you choose which app will control the lighting effects on your device.

General

The General subtab is the section where you can access miscellaneous options for your app, as well as find additional information about the software.

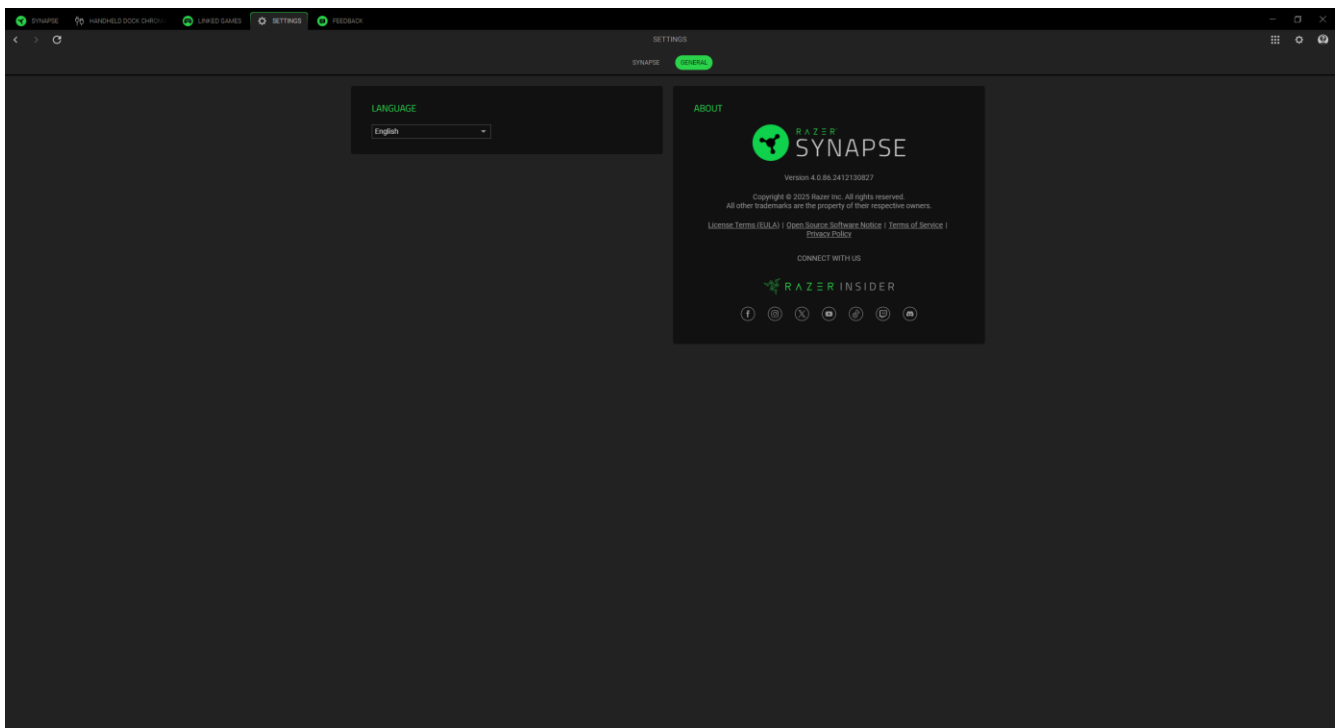

Language

This option lets you change the display language of Razer Synapse.

About

The About section shows the current software version, displays the copyright statement, and provides relevant links for Razer's terms of use. You may also use this option to access Razer's social communities quickly.

FEEDBACK

Help us improve Razer Synapse by giving your comments, suggestions, and problems with the software. You can contact us directly using this tab and even earn rewards for reporting bugs.

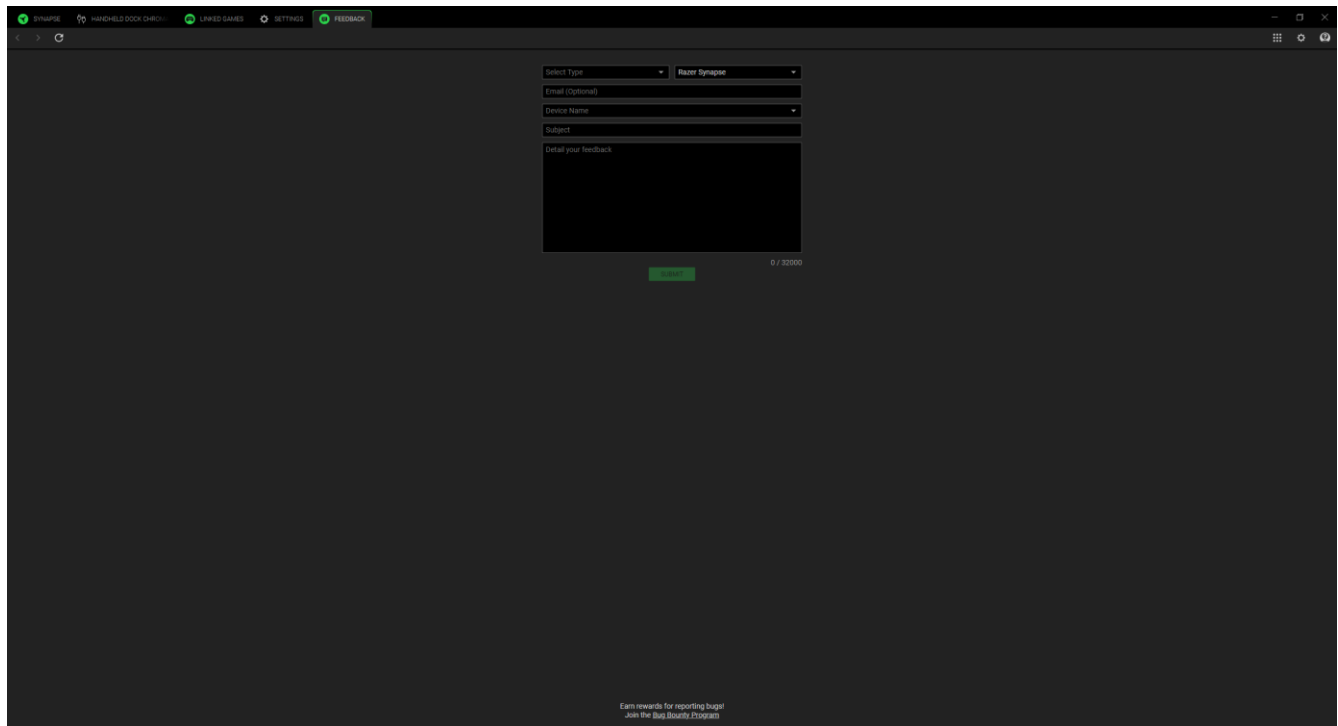

The screenshot shows the Razer Synapse software interface with the 'FEEDBACK' tab selected. The form includes the following fields:

- Select Type: Razer Synapse
- Email (Optional)
- Device Name
- Subject
- Detail your feedback (0 / 20000)

At the bottom of the form is a green 'SEND' button. At the bottom of the screen, there is a small text prompt: 'Earn rewards for reporting bugs! Join the Razer Rewards Program'.

7. SAFETY AND MAINTENANCE

SAFETY GUIDELINES

In order to achieve maximum safety while using your Razer Handheld Dock Chroma, we suggest that you adopt the following guidelines:

Should you have trouble operating the device properly and troubleshooting does not work, unplug the device and contact the Razer hotline or go to support.razer.com for assistance.

Do not take apart the device (doing so will void your warranty) and do not attempt to operate it under abnormal current loads.

Keep the device away from liquid, humidity or moisture. Operate the device only within the specific temperature range of 0°C (32°F) to 40°C (104°F). Should the temperature exceed this range, unplug and/or switch off the device in order to let the temperature stabilize to an optimal level.

MAINTENANCE AND USE

The Razer Handheld Dock Chroma requires minimum maintenance to keep it in optimum condition. Once a month we recommend you unplug the device from the computer and clean it using a soft cloth or cotton swab to prevent dirt buildup. Do not use soap or harsh cleaning agents.

8. LEGALESE

COPYRIGHT AND INTELLECTUAL PROPERTY INFORMATION

©2025 Razer Inc. All rights reserved. Razer, the triple-headed snake logo, Razer logo, and “For Gamers. By Gamers.”, are trademarks or registered trademarks of Razer Inc. and/or affiliated companies in the United States or other countries. All other trademarks are the property of their respective owners.

The terms HDMI, HDMI High-Definition Multimedia Interface, HDMI Trade dress and the HDMI Logos are trademarks or registered trademarks of HDMI Licensing Administrator, Inc.



Razer Inc. (“Razer”) may have copyright, trademarks, trade secrets, patents, patent applications, or other intellectual property rights (whether registered or unregistered) concerning the product in this guide. Furnishing of this guide does not give you a license to any such copyright, trademark, patent or other intellectual property right. The Razer Handheld Dock Chroma (the “Product”) may differ from pictures whether on packaging or otherwise. Razer assumes no responsibility for such differences or for any errors that may appear. Information contained herein is subject to change without notice.

LIMITED PRODUCT WARRANTY

For the latest and current terms of the Limited Product Warranty, please visit [razer.com/warranty](https://www.razer.com/warranty).

LIMITATION OF LIABILITY

Razer shall in no event be liable for any lost profits, loss of information or data, special, incidental, indirect, punitive or consequential or incidental damages, arising in any way out of distribution of, sale of, resale of, use of, or inability to use the Product. In no event shall Razer’s liability exceed the retail purchase price of the Product.

GENERAL

These terms shall be governed by and construed under the laws of the jurisdiction in which the Product was purchased. If any term herein is held to be invalid or unenforceable, then such term (in so far as it is invalid or unenforceable) shall be given no effect and deemed to be excluded without invalidating any of the remaining terms. Razer reserves the right to amend any term at any time without notice.