



RAZER BASILISK V3 PRO 35K

MASTER GUIDE

CONTENTS

1. WHAT'S INSIDE	2
2. WHAT'S NEEDED	4
3. LET'S GET YOU COVERED	4
4. GETTING STARTED	5
5. USING YOUR RAZER BASILISK V3 PRO 35K.....	9
6. CONFIGURING YOUR RAZER BASILISK V3 PRO 35K.....	11
7. SAFETY AND MAINTENANCE	35
8. LEGALESE.....	37

1. WHAT'S INSIDE

- Razer Basilisk V3 Pro 35K

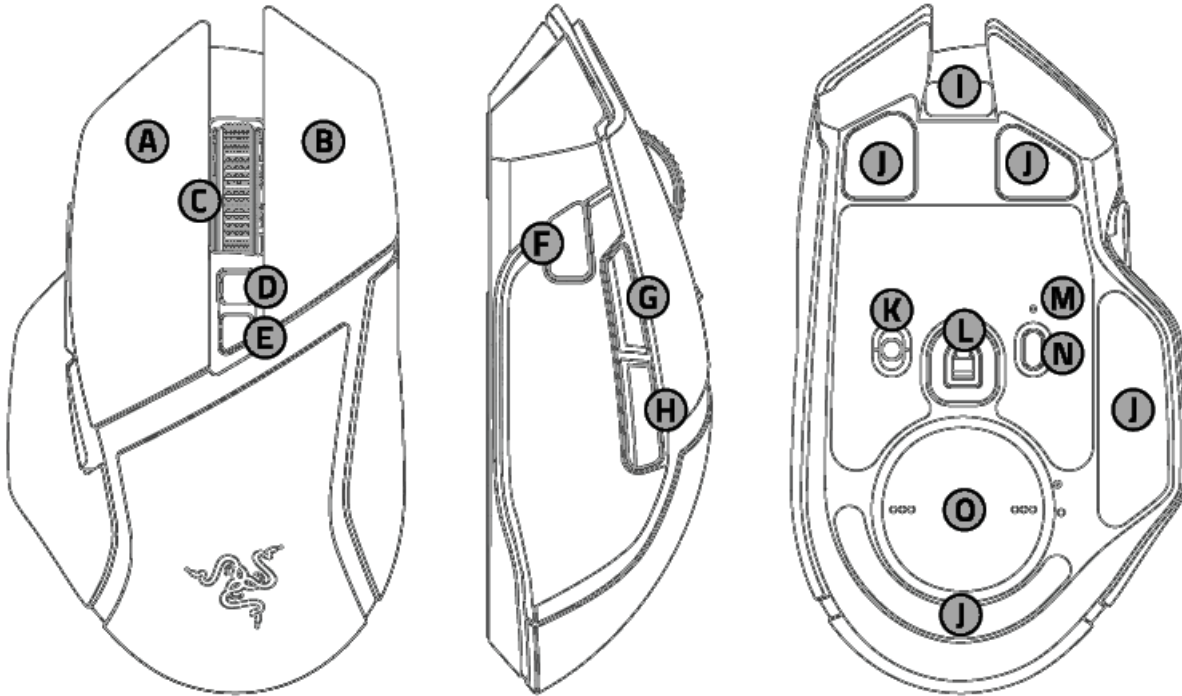

- A.** Left mouse button
- B.** Right mouse button
- C.** Razer™ HyperScroll Tilt Wheel
- D.** Scroll mode button
 - Free-Spin Scrolling mode
 - Tactile Cycling mode
- E.** DPI cycle button
- F.** Multi-function trigger
- G.** Mouse button 5
- H.** Mouse button 4
- I.** USB Type C port

- J.** PTFE mouse feet
- K.** Slider switch
 - Bluetooth mode
 - Power off mode
 - Razer™ HyperSpeed Wireless (2.4 GHz) mode
- L.** Razer™ Focus Pro 35K Optical Sensor Gen-2
- M.** Profile indicator
- N.** Profile button
- O.** Wireless USB dongle compartment / cover puck**



*The DPI stages are as follows: 400, 800, 1600 (default), 3200 and 6400. The DPI stages can be customized using Razer Synapse. **The cover puck is interchangeable with the Razer Wireless Charging Puck for wireless charging via Razer Mouse Dock Pro (each sold separately).*

- Razer™ Hyperspeed Wireless dongle + USB dongle adapter



- USB Type A to USB Type C cable

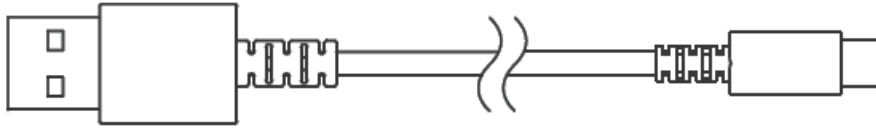

- Important Product Information Guide

2. WHAT'S NEEDED

PRODUCT REQUIREMENTS

- USB Type A port or Bluetooth connectivity

RAZER SYNAPSE REQUIREMENTS

- Windows® 10 64-bit (or higher)
- macOS 15 with Apple Silicon "M" series (or higher)
- Internet connection for software installation

3. LET'S GET YOU COVERED

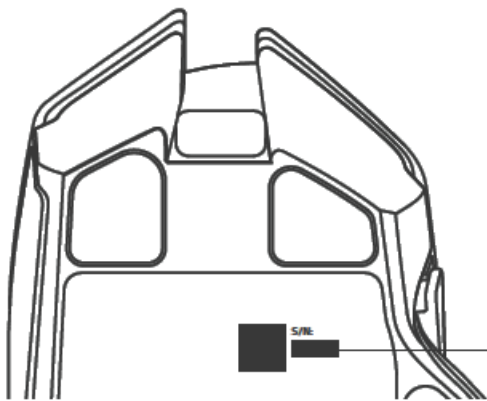

Your product's serial number can be found here.



Register your product and score exclusive benefits

razerid.razer.com/warranty

4. GETTING STARTED

CHARGE YOUR MOUSE

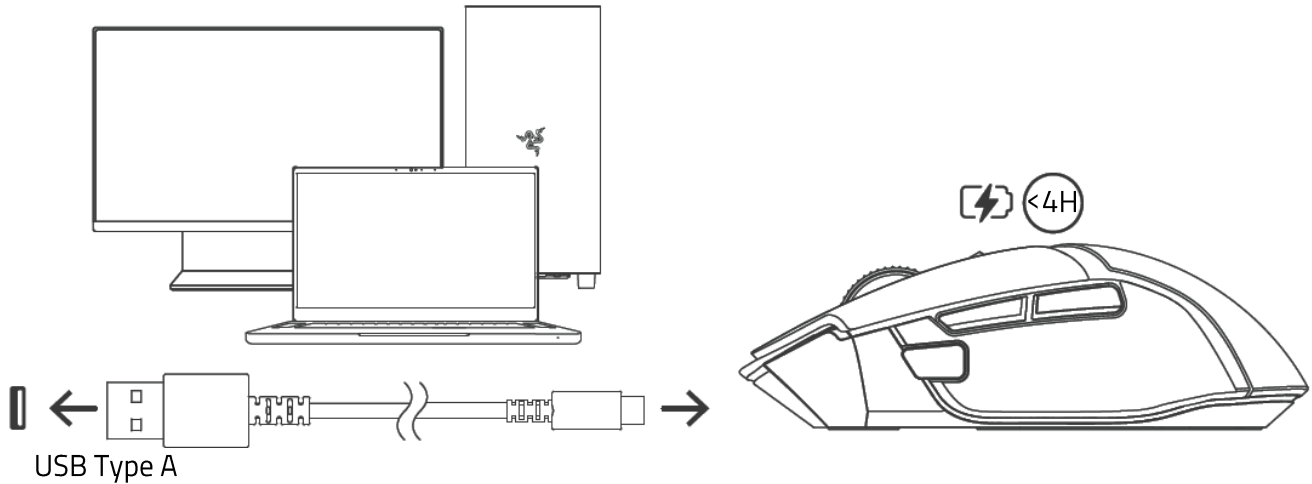

- i** For best results, connect your Razer Basilisk V3 Pro 35K directly to the USB port of your computer using the provided cable.

CONNECT TO YOUR DEVICE

WIRED MODE

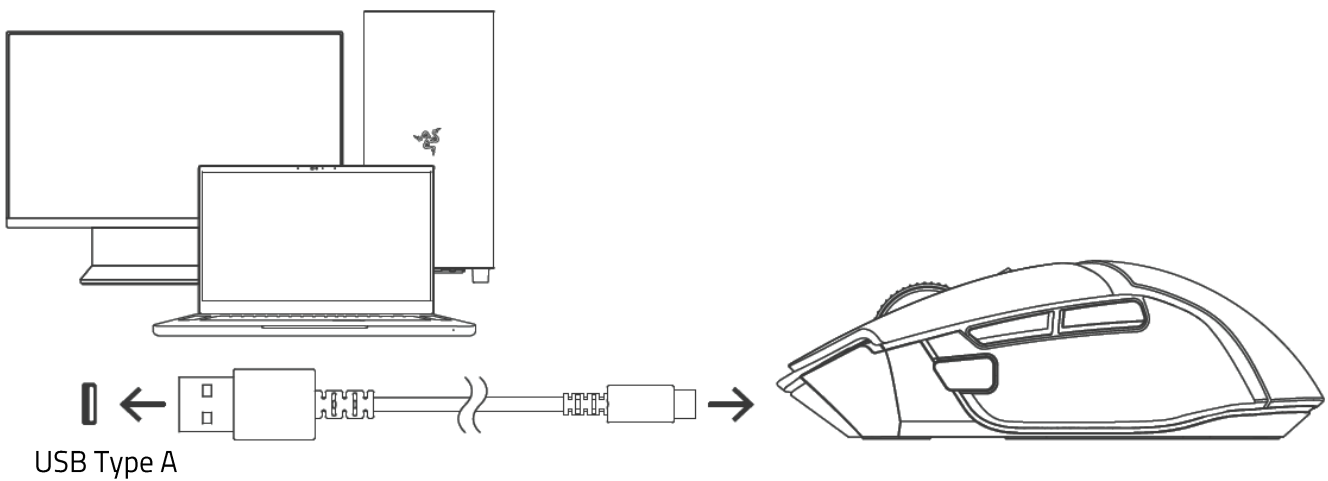

RAZER™ HYPERSPEED WIRELESS MODE

1.

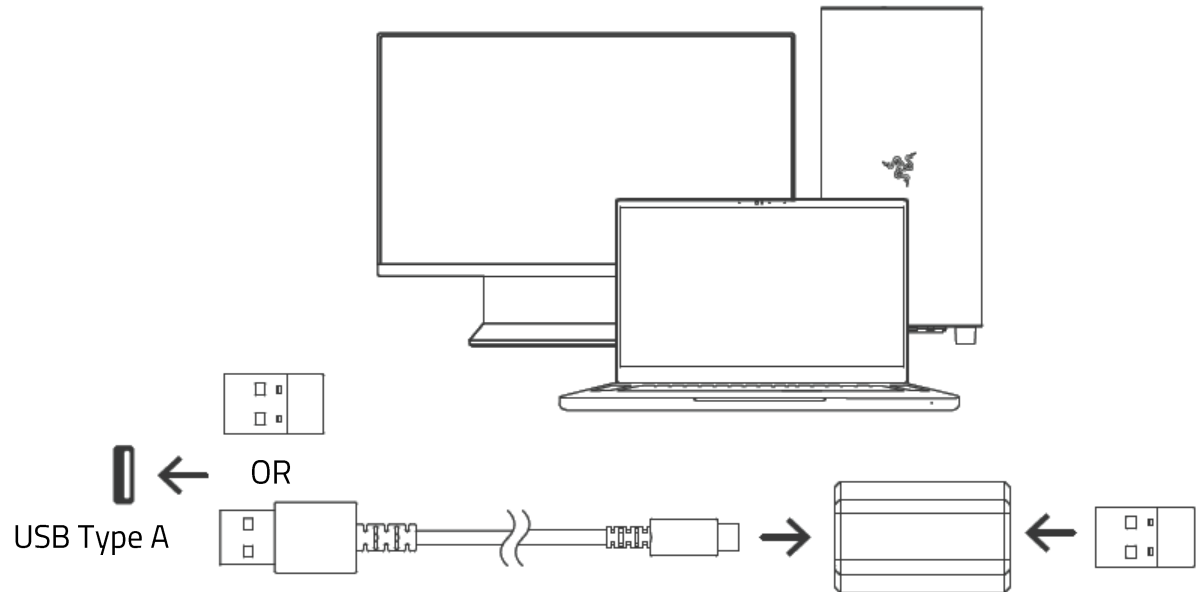

2.

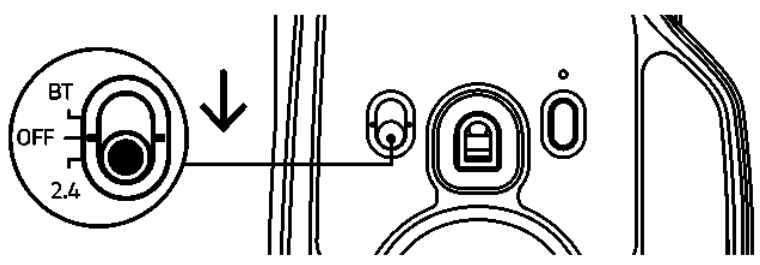

3.

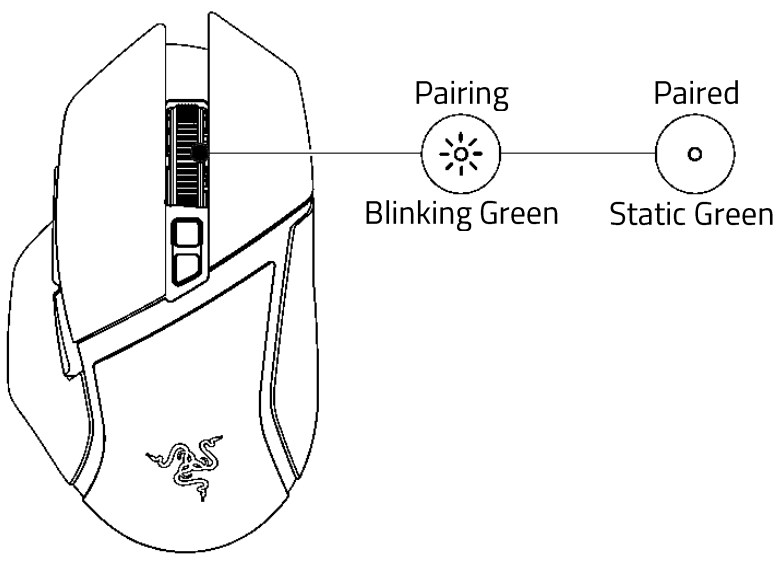

BLUETOOTH MODE

1.

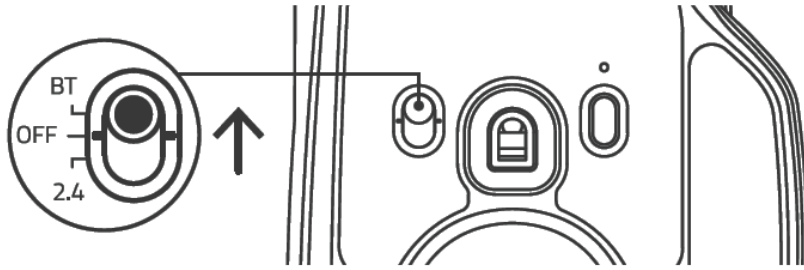

2.

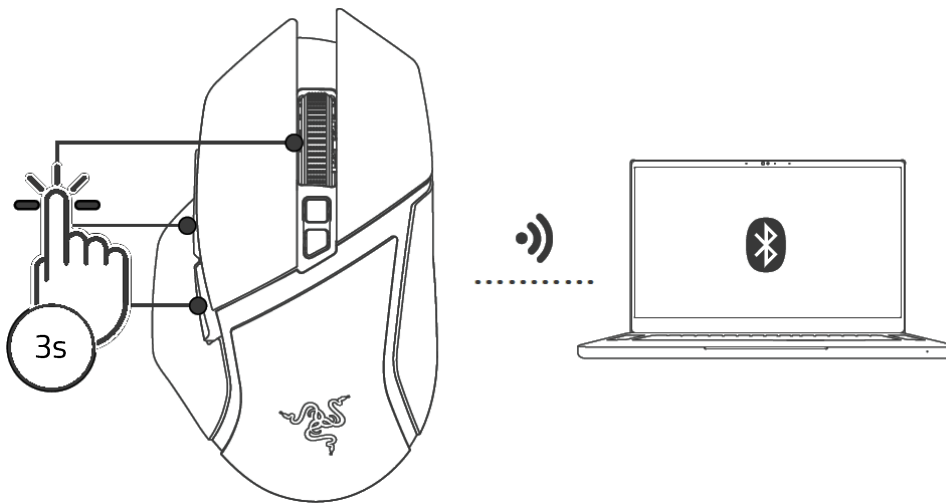

3.

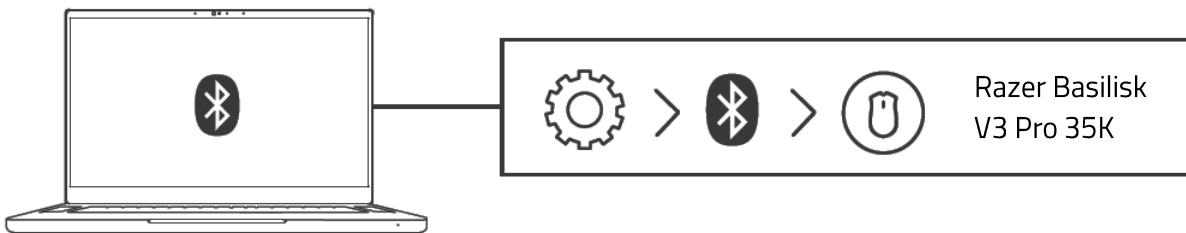

4.

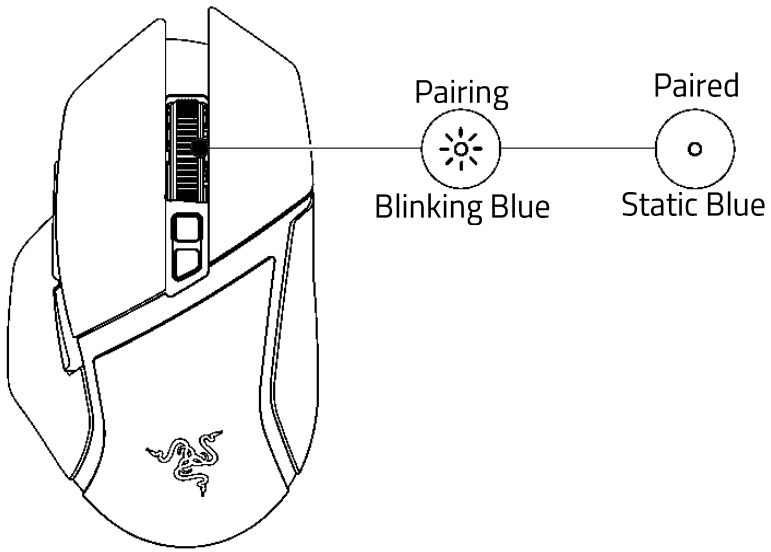

i Install Razer Synapse when prompted or download the installer from razer.com/synapse

5. USING YOUR RAZER BASILISK V3 PRO 35K

ACTIVATE THE MULTI-FUNCTION TRIGGER

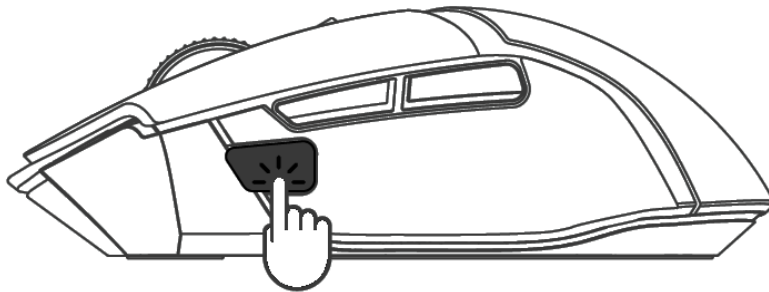

Press and hold

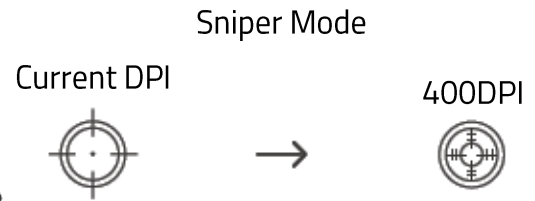

- i** *Customize the Sniper Mode's DPI or remap the Multi-Function Trigger for other tasks using Razer Synapse.*

SWITCH SCROLL MODES

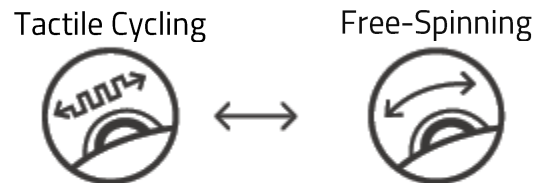
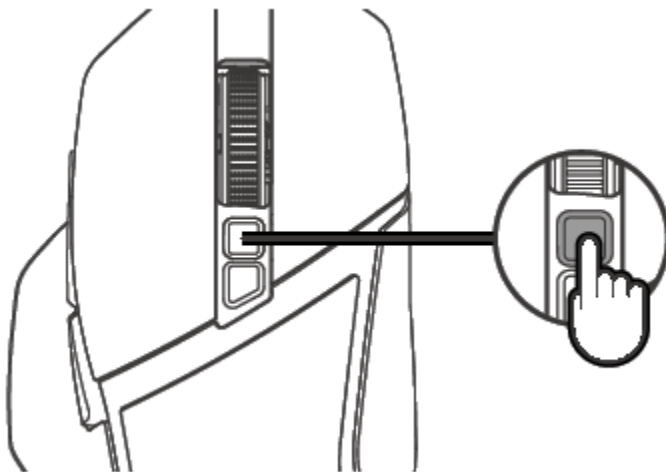

- i** *You can also use Razer Synapse to set the mouse to Smart-Reel mode where the Razer™ HyperScroll Tilt Wheel will automatically switch between Free-Spinning mode and Tactile Cycling mode.*

PERSONALIZE YOUR MOUSE

Your Razer Basilisk V3 Pro 35K can store up to 5 profiles from the Razer Synapse app, allowing you to use these profiles even on systems without the app installed. Pressing the profile button will cycle through the different profiles, with the profile indicator's color showing which profile is currently selected.

Profile	Designated color
Active Profile	White
Profile 1	Red
Profile 2	Green
Profile 3	Blue
Profile 4	Cyan

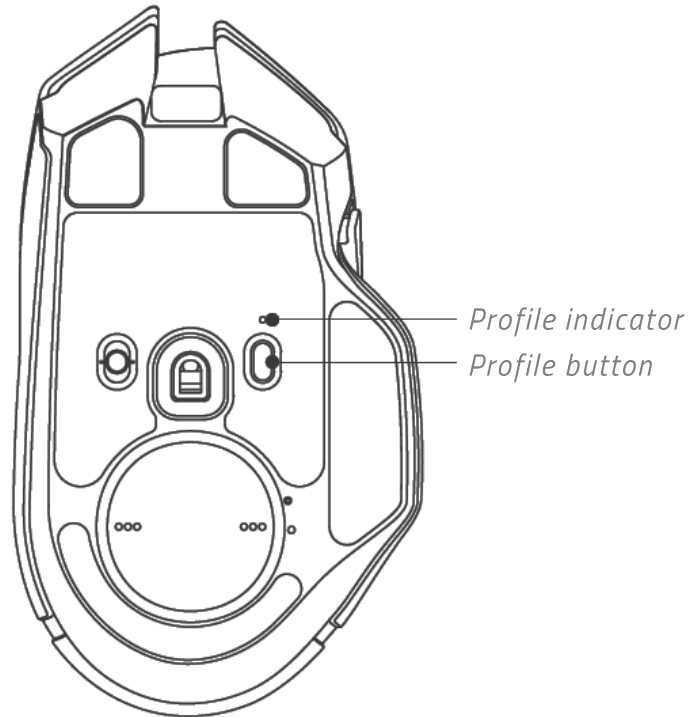

Install Razer Synapse when prompted or download the installer from razer.com/synapse. Use the Razer Synapse app to customize your mouse's lighting, configure its multi-function trigger and buttons, and even create various profiles suited for different playstyles.

Find out more about your gaming-grade mouse at support.razer.com

6. CONFIGURING YOUR RAZER BASILISK V3 PRO 35K



i *Disclaimer: This guide provides an overview of the New Razer Synapse app and may only partially cover some of the features of your device. The New Razer Synapse requires an Internet connection to install, update, access, and save cloud-based features. Registering for a Razer ID account is recommended but optional. All features listed here are subject to change based on the current version, connected device(s), and supported add-ons.*

SYNAPSE

The Synapse tab is your default tab when you first launch Razer Synapse. Use the following buttons below to navigate the user interface:

— Minimize (or  for Mac)

Clicking this button will minimize the app to the taskbar while it runs in the background.

 Maximize (or  for Mac)

This button expands the browser window to fill the entire screen. To restore the window to its original size, click the maximize button again.

× Close (or  for Mac)

This button will close all relevant tabs and terminate the application completely.

< Previous Tab

Clicking this button will return you to the last tab you have visited.

> Next Tab

Clicking this button will move you to the next page if you've recently used the Previous Tab button.

 Refresh Tab

This button reloads the current page. Use this if a page isn't displaying correctly or you want to see the latest content.

⬇ Download Update

If this button appears, that means there are changes to the app. Use this if a page isn't displaying correctly or you want to see the latest content.

More

Clicking this button will open a pop-up so you can easily access your Devices, Modules, and Other Installed Apps tabs.

Settings

Clicking this button will open the Settings tab, so you can quickly change the settings to this app.

Profile

This button will open a pop-up to access the Log In, Feedback, Rate This Software, Add WiFi Device, and Exit options.

Info

Hovering over this button will pop up an additional information about a feature or function.

Dashboard

The Dashboard subtab is an overview of your Razer Synapse, where you can access all your Razer devices, modules, and online services.

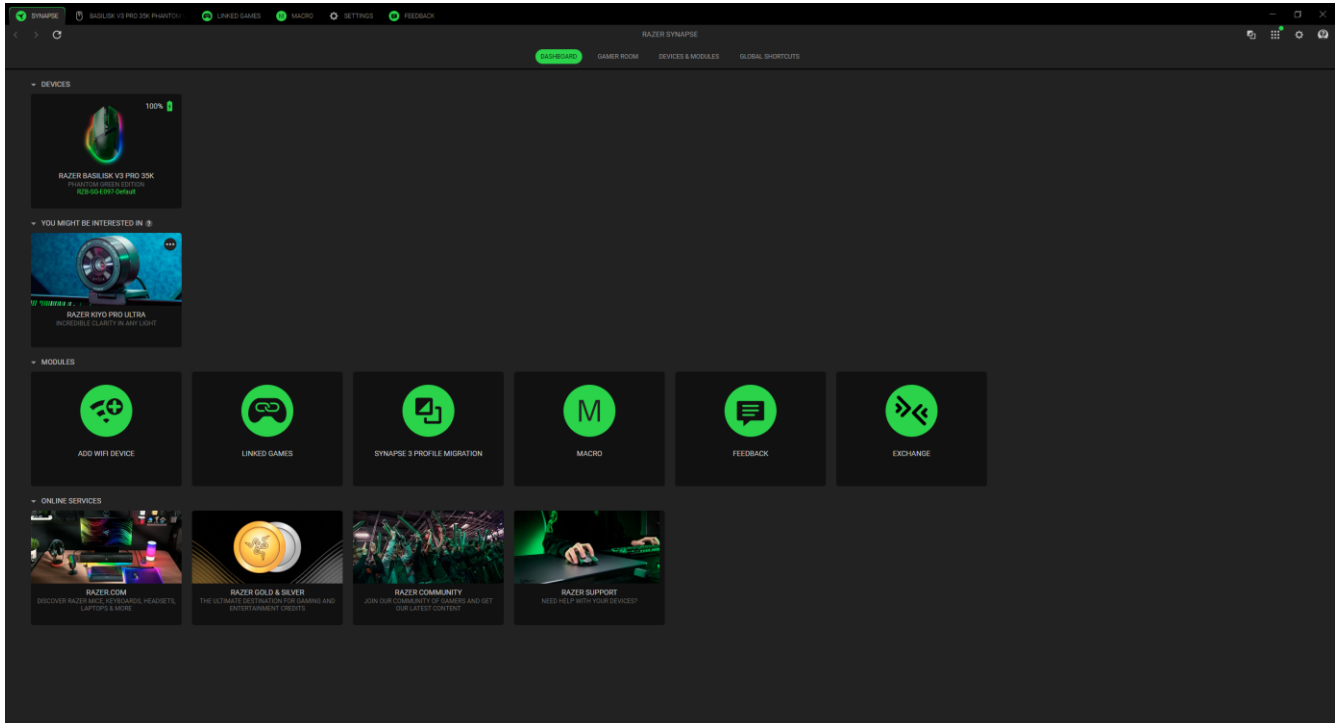

Gamer Room

The Gamer Room subtab shows all devices with the Razer Aether Light feature. From here, you can view and manage your Gamer Room-supported devices.

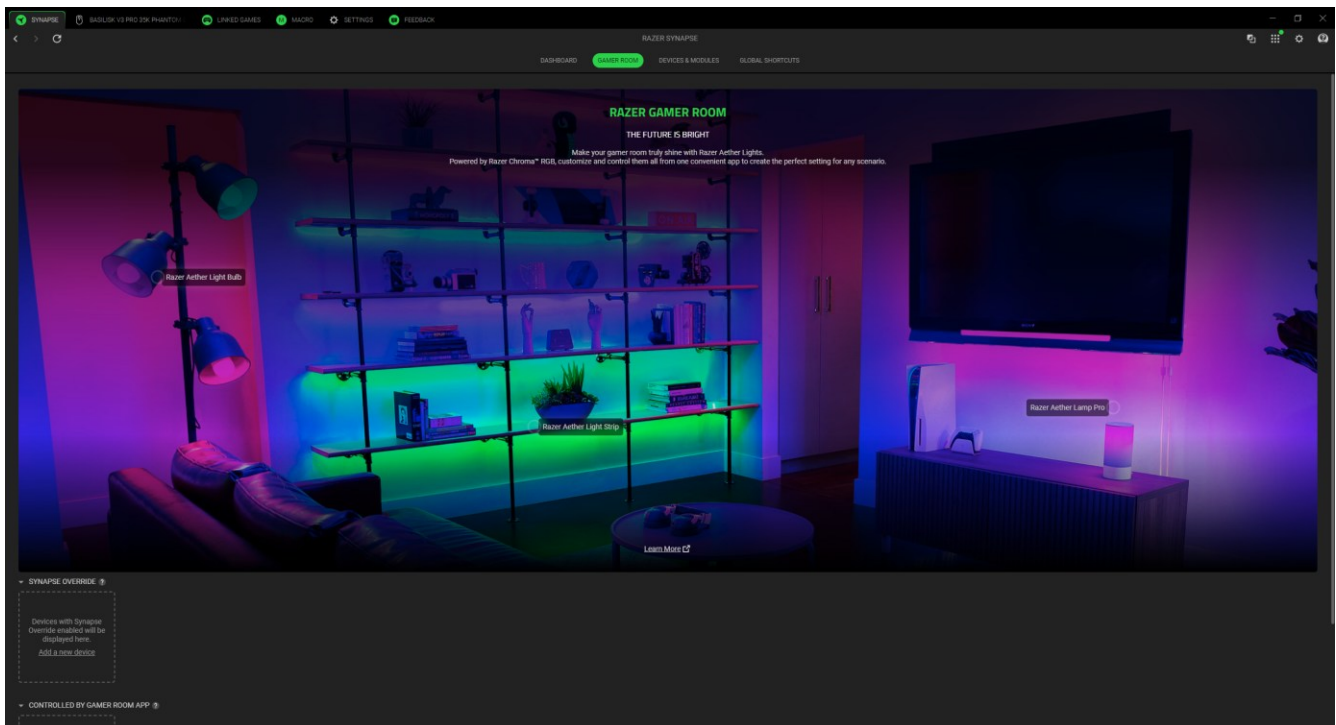

Synapse Override

This section allows you to select and customize your device's lighting and make it react to Chroma-enabled games and Chroma Connect apps using Razer Synapse.

Controlled By Gamer Room App

This section displays all supported devices controlled remotely by the Gamer Room app.

Devices & Modules

The Modules subtab displays all installed and available modules for installation.

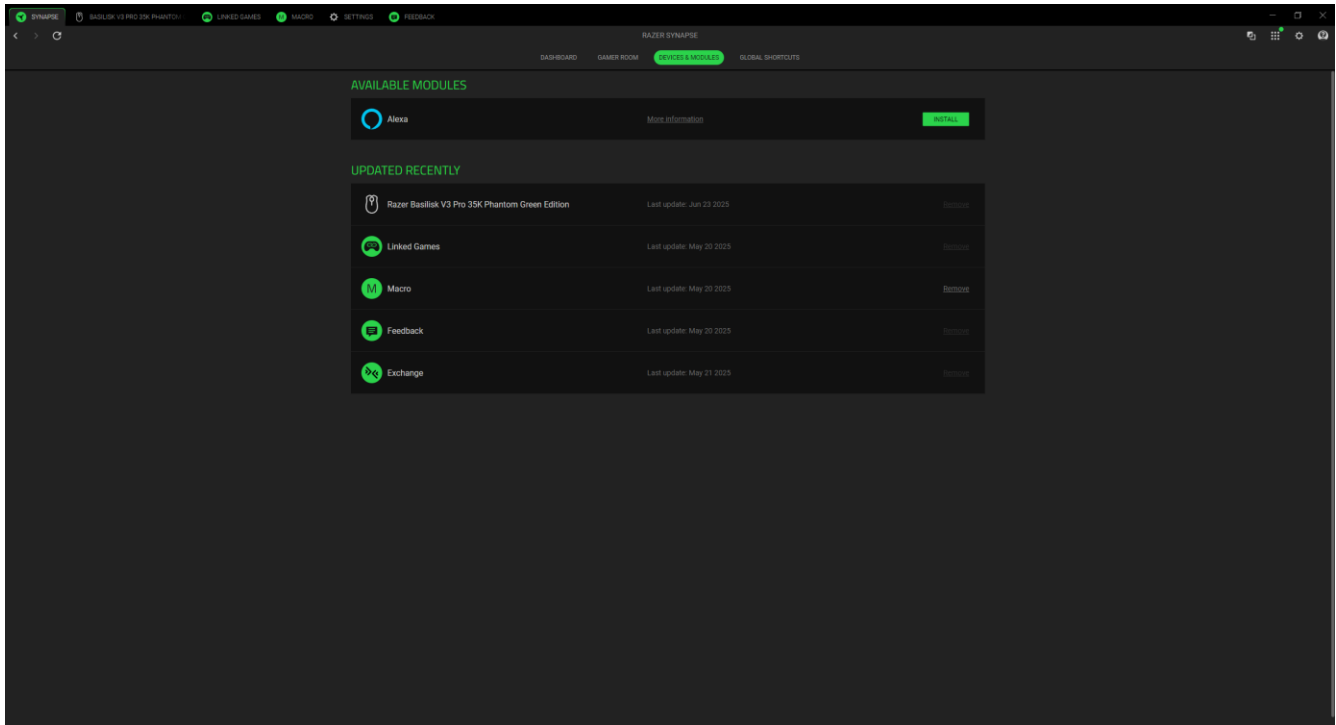

Global Shortcuts

Bind operations or Razer Synapse functions to custom key-combinations from any Razer Synapse-enabled device inputs, which apply across all device profiles.

 *Only Razer Synapse-enabled device inputs will be recognized.*

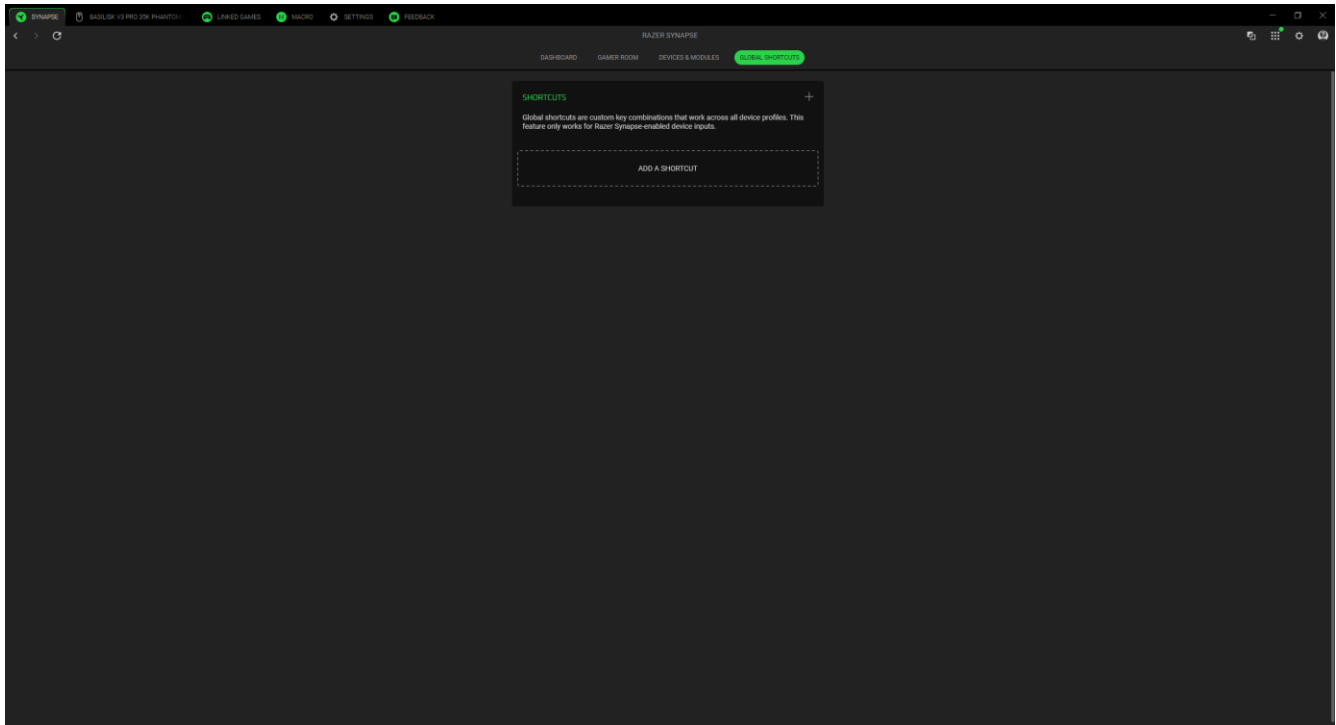

BASILISK V3 PRO 35K

The Basilisk V3 Pro 35K tab is the main tab for your Razer mouse. You can change your device settings from here, such as button assignment, stored profiles, DPI sensitivity, polling rate and lighting. Any changes under this tab will be saved automatically to your local system and cloud storage. Use the following buttons below to access your profile options:

▾ Profiles Dropdown Bar

Clicking this dropdown bar will display all the profiles for this device so you can quickly change profiles.

⋮ Miscellaneous

Clicking this button will open a pop-up with options related to your current profile.

💾 On-board Profiles

If your device supports on-board memory, clicking this button shows the remaining storage and allows you to transfer or change the saved profiles on your device.

Customize

The Customize subtab is for modifying your mouse's button assignments.

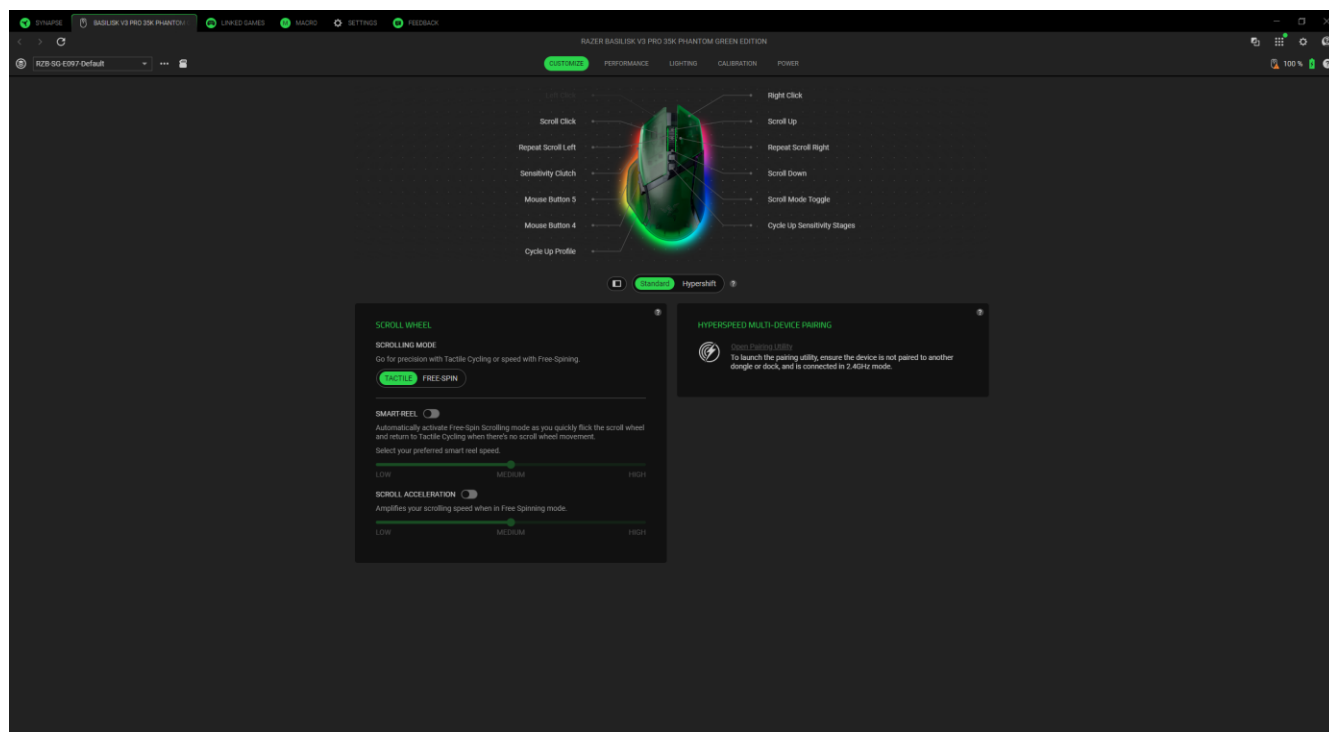

Profile

Profile is a data storage system that keeps all your Razer device settings. By default, the profile name is based on your system's name. Clicking the dropdown bar (▾) will display all profiles for this device so you can quickly switch between them. To add, import, rename, duplicate, export, or delete a profile, press the profile's corresponding Miscellaneous button (⋮).

Scroll wheel

Customize the way the Razer™ HyperScroll Tilt Wheel speeds through content.

Scrolling mode

Switch between Tactile mode to enjoy more precision with satisfying feedback or Free-spin mode to speed through content with ease.

Smart-Reel

Smart-reel enables the mouse to switch between Free-Spin and Tactile mode automatically. When enabled, the scroll wheel will automatically activate Free-Spin mode when performing fast scrolling movements and revert to Tactile mode when there's no scroll movement.

Scroll acceleration

Enable Razer Synapse to detect how fast you scroll and virtually amplify the scroll wheel's movement the faster you scroll through content.

Hypershift

Hypershift mode is a secondary set of button assignments activated when the Hypershift key is held down. By default, the Hypershift key is assigned to the fn key of your Razer Synapse-supported keyboard. However, you can also set any mouse button as a Hypershift key.

HyperSpeed Multi-Device Pairing

Use this feature to pair an additional HyperSpeed-compatible device with the wireless USB dongle of your Razer Basilisk V3 Pro 35K. As its wireless USB dongle can support a keyboard and mouse simultaneously, you'll be able to remove the usage of separate dongles for each peripheral.



Your Razer Basilisk V3 Pro 35K must be connected via HyperSpeed (2.4 GHz) wireless mode to use this feature. Each peripheral can only connect to one dongle at a time.

Remap Menu

Clicking the Remap Menu button () will reveal all current assignments for your Razer mouse and allow you to modify them.

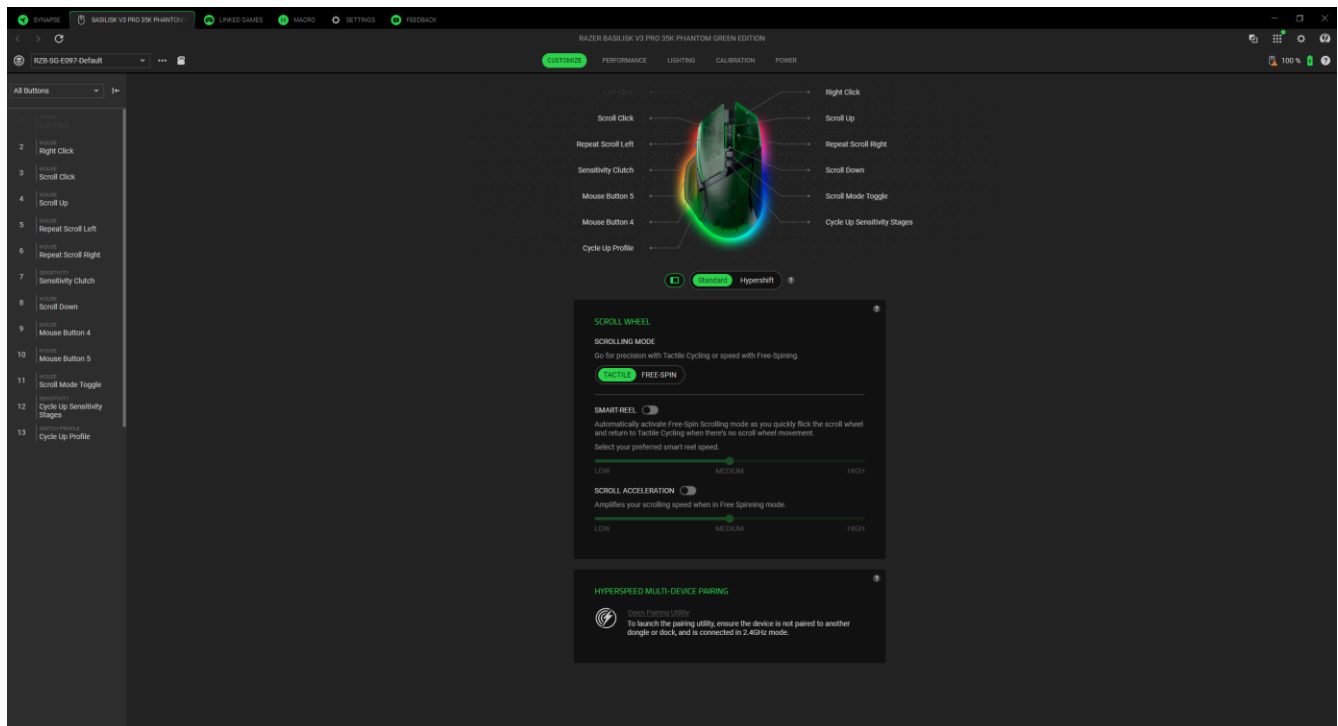

Alternatively, you can skip to a specific assignment by selecting it on the Customize tab.

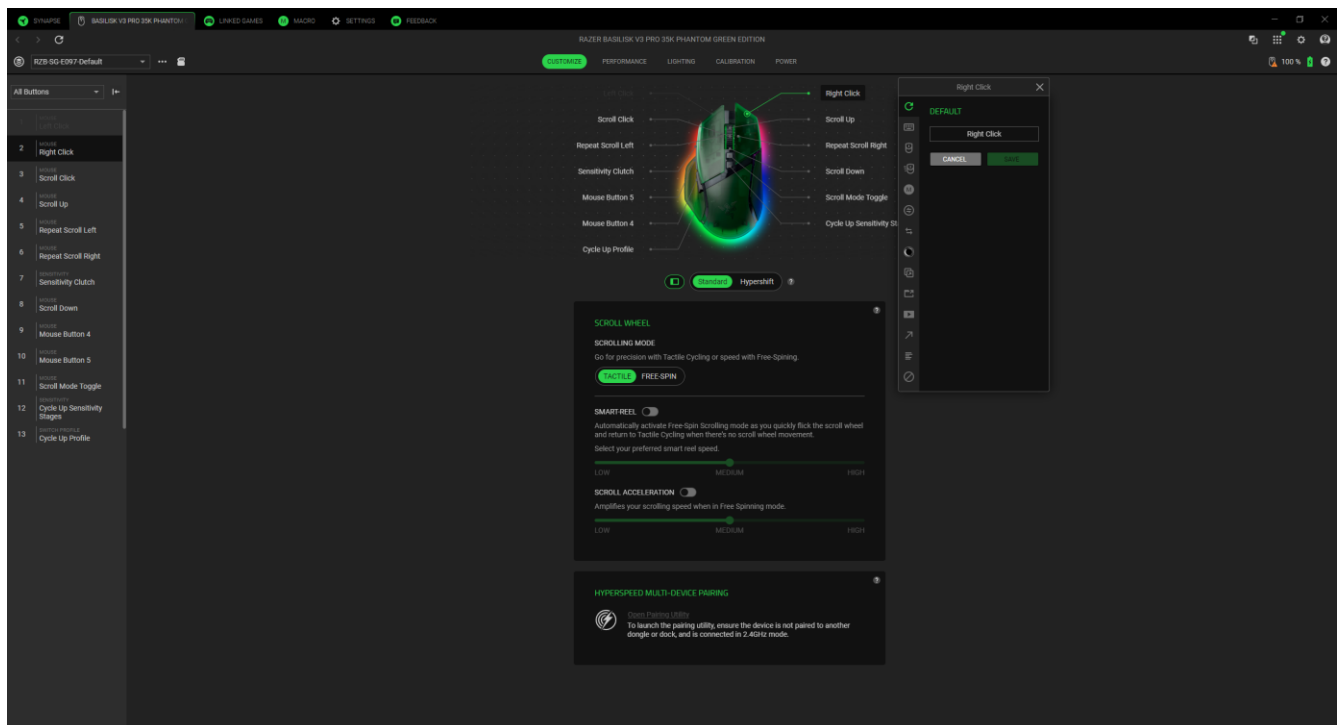

Upon selecting an assignment, you may then change it to one of the following functions:

Default

This option enables you to return the selected button to its original setting.

Keyboard Function

This option changes the button assignment into a keyboard function. You can also enable Turbo mode, which allows you to emulate a repeated keyboard function while the button is held down.

Mouse Function

This option substitutes the current button assignment for another mouse function. Listed below are the functions which you can choose from:

- Left Click - Performs a left mouse click using the assigned button.
- Right Click - Performs a right mouse click using the assigned button.
- Scroll Click - Activates the universal scrolling function.
- Double Click - Performs a double left click using the assigned button.
- Scroll Up - Performs a "Scroll Up" command using the assigned button.
- Scroll Down - Performs a "Scroll Down" command using the assigned button.
- Mouse Button 4 - Performs a "Backward" command for most internet browsers.
- Mouse Button 5 - Performs a "Forward" command for most internet browsers.
- Scroll Left - Performs a "Scroll Left" command using the assigned button.
- Scroll Right - Performs a "Scroll Right" command using the assigned button.

You can also choose to enable Turbo mode in some of the mouse functions, which allow you to emulate repeatedly pressing and releasing said function while the button is held down.

Sensitivity

This function allows you to manipulate the DPI setting of your Razer Basilisk V3 with a touch of a button. Listed below are the Sensitivity options and their description:

- Sensitivity Clutch - Changes the sensitivity to a predefined DPI while the designated button is held down. Releasing the button will return it to the previous sensitivity.
- Sensitivity Stage Up - Increases the current sensitivity by one stage.
- Sensitivity Stage Down - Decreases the current sensitivity by one stage.

- On-The-Fly Sensitivity - Pressing the designated button and moving the scroll wheel either up or down will increase or decrease the current DPI respectively.
- Cycle Up Sensitivity Stages - Increases the current sensitivity stage by one. Once it reaches the highest sensitivity stage, it will return to stage 1 when the button is pressed again.
- Cycle Down Sensitivity Stages - Decreases the current sensitivity stage by one. Once it reaches stage 1, it will return to the highest sensitivity stage when the button is pressed again.

Macro

A Macro is a prerecorded sequence of keystrokes and button presses that is executed with precise timing. By setting the button function to Macro, you can conveniently execute a chain of commands. This function will only be visible when the Macro module is installed.

Inter-device

Inter-device allows you to change the functionality of other Razer Synapse-enabled devices. Some of these functionalities are device-specific such as using your Razer gaming keyboard to change the Sensitivity Stage of your Razer gaming mouse.

Switch Profile

Switch Profile lets you quickly change profiles and load a new set of button assignments. An on-screen notification will appear whenever you switch profiles.

Switch Chroma Effect

Switch Chroma Effect allows you to easily switch between all Chroma Effect Profiles in Chroma Studio. This function will only be visible when the Chroma Studio module is installed.

Razer Hypershift

Setting the button to Razer Hypershift will allow you to activate Hypershift mode as long as the button is held down.

Launch

Launch Program lets you open an app or a website using the assigned button. When you select Launch Program, two choices will appear, which require you to search for a specific app you want to open or write the website address you want to visit.

Multimedia

This option allows you to assign multimedia controls to your Razer device. Listed below are the multimedia controls you can choose from:

- Volume Down - Decreases the audio output.
- Volume Up - Increases the audio output.
- Mute Volume - Mutes the audio.
- Mic Volume Up - Increases the microphone volume.
- Mic Volume Down - Decreases the microphone volume.
- Mute Mic - Mutes the microphone.
- Mute All - Mutes both microphone and audio output.
- Play / Pause - Play, pause, or resume current media playback.
- Previous Track - Play the previous media track.
- Next Track - Play the next media track.

Windows Shortcuts

This option allows you to assign your preferred button to a Windows Operating System shortcut command. For more information, please visit: support.microsoft.com/kb/126449

Text Function

Text Function enables you to type a prewritten text with a touch of a button. Simply write your desired text on the given field, and your text will be typed whenever the assigned button is pressed. This function has full Unicode support, and you can also insert special symbols from character maps.

Disable

This option renders the assigned button unusable. Use Disable if you do not want to use the selected button or if it interferes with your gaming.

Performance

The Performance subtab enables you to adjust the sensitivity, acceleration, and polling rate of your Razer mouse.

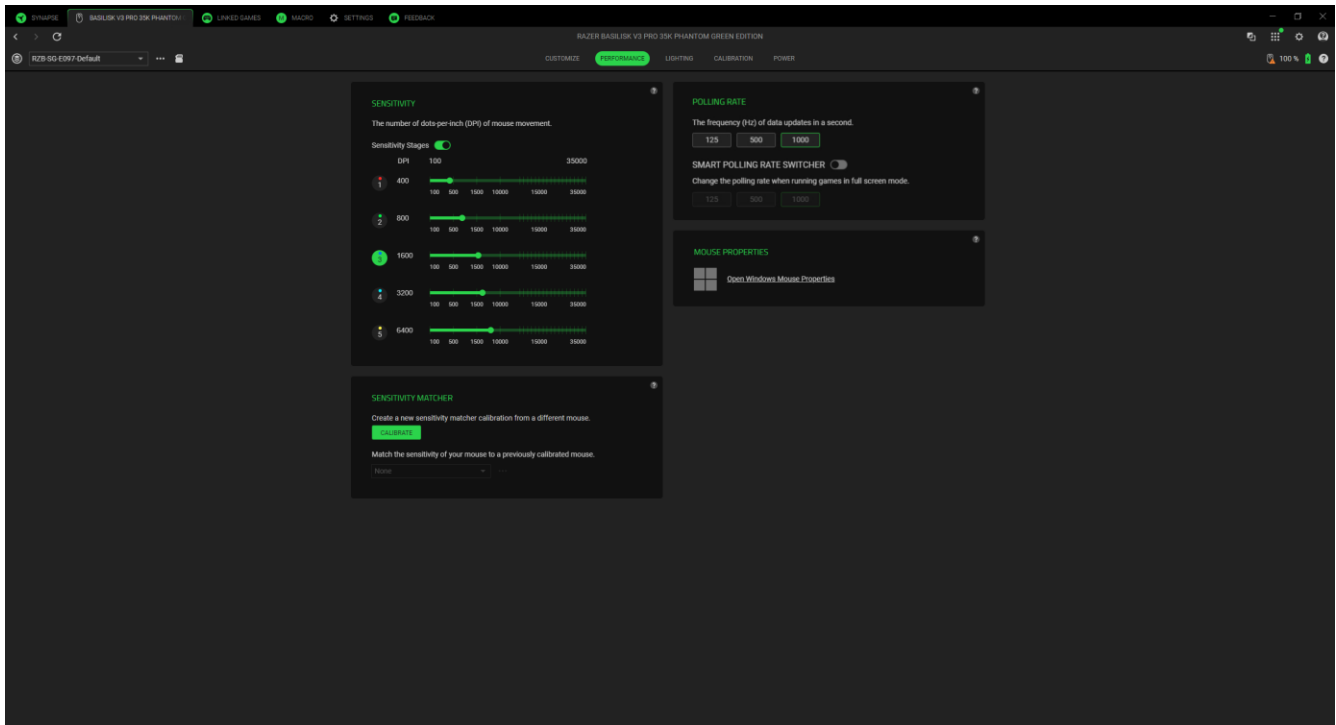

Sensitivity

Sensitivity refers to the distance the cursor travels based on the distance the mouse moves. The higher the DPI, the farther the cursor will travel, given the same distance of mouse movement.

Sensitivity Stages

A sensitivity stage is a preset sensitivity value. You can create up to 5 different sensitivity stages, which you can cycle through using the DPI cycle button or DPI Stage Up/down buttons on your Razer mouse. Hovering over any sensitivity stage allows you to toggle each stage or enable the Enable X-Y function for each one.

Sensitivity Matcher

Adjust your mouse settings to make it feel like you're using a different mouse. You'll need to connect to a second mouse to use this feature.

Polling Rate

You can switch between any of the polling rate options by selecting your desired polling rate. The higher the polling rate, the more frequently the computer receives information about your mouse's status, effectively reducing input latency and improving your mouse pointer's responsiveness.

Smart Polling Rate Switcher

When you enable this feature, your mouse will automatically switch to a different polling rate when an app is in full-screen mode.

Mouse Properties

Access the Windows Mouse Properties, where you can modify operating system settings that directly affect your Razer mouse.

Lighting

The Lighting subtab enables you to modify your Razer device's light settings.

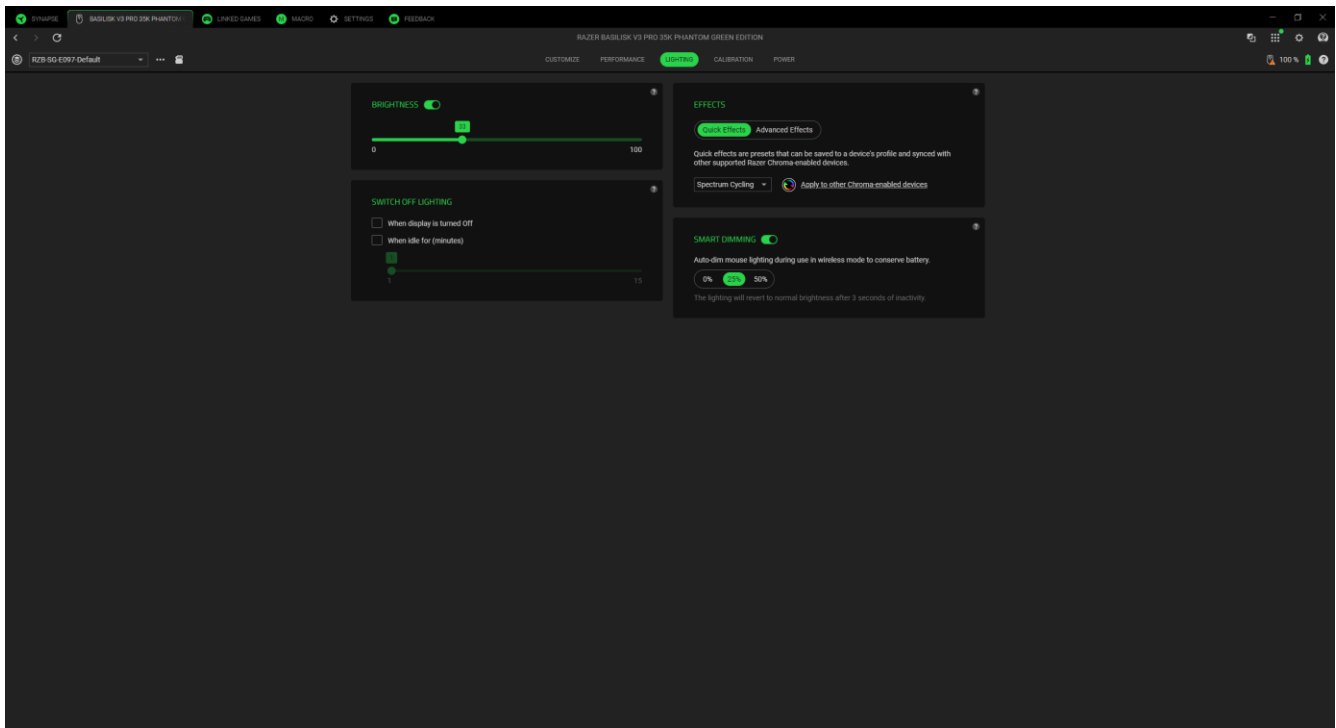

Brightness







You can turn off your Razer device's lighting by toggling the Brightness option or increase/decrease the luminance using the slider.

Switch Off Lighting

This is a power saving tool which allows you to disable your device's lighting in response to your system's display turning off and/or automatically power down when your device has been idle for a set amount of time.

Quick Effects

A number of quick effects can be selected and applied to your device's lighting, as listed here:

	Name	Description	How to set up
	Audio meter	The mouse will light up according to the audio level with a default spectrum of colors	Select a Color Boost level
	Breathing	The lighting will fade in and out of the selected color(s)	Select up to 2 colors or randomize colors
	Fire	The LEDs will light up in warm colors to mimic the motion of flames	No further customization required
	Reactive	The mouse will light up when you click any of the mouse buttons	Select a color and a duration
	Spectrum cycling	The lighting will cycle between 16.8 million colors indefinitely	No further customization required
	Starlight	Each LED will have a chance of fading in and out at a random time and duration	Select up to 2 colors or randomize colors and select a duration
	Static	The mouse will remain lit in the selected color	Select a color
	Wave	The lighting will scroll in the direction selected	Select a wave direction

If you have other supported Razer Chroma-enabled devices, you can synchronize their quick effects with your Razer device by clicking the Chroma Sync button ().

Advanced Effects

The Advanced Effects option allows you to choose a Chroma Effect Profile you want to use on your Razer Chroma-enabled peripheral. To start making your own Chroma Effect Profile, press the Launch Chroma Studio button ().

 *Some lighting effects listed here may not be available for your device. Only other Razer devices that support the selected lighting effect will synchronize. Indicator LEDs are not customizable.*

Calibration

The Calibration subtab allows you to optimize the sensor of your Razer mouse to any surface for better tracking.

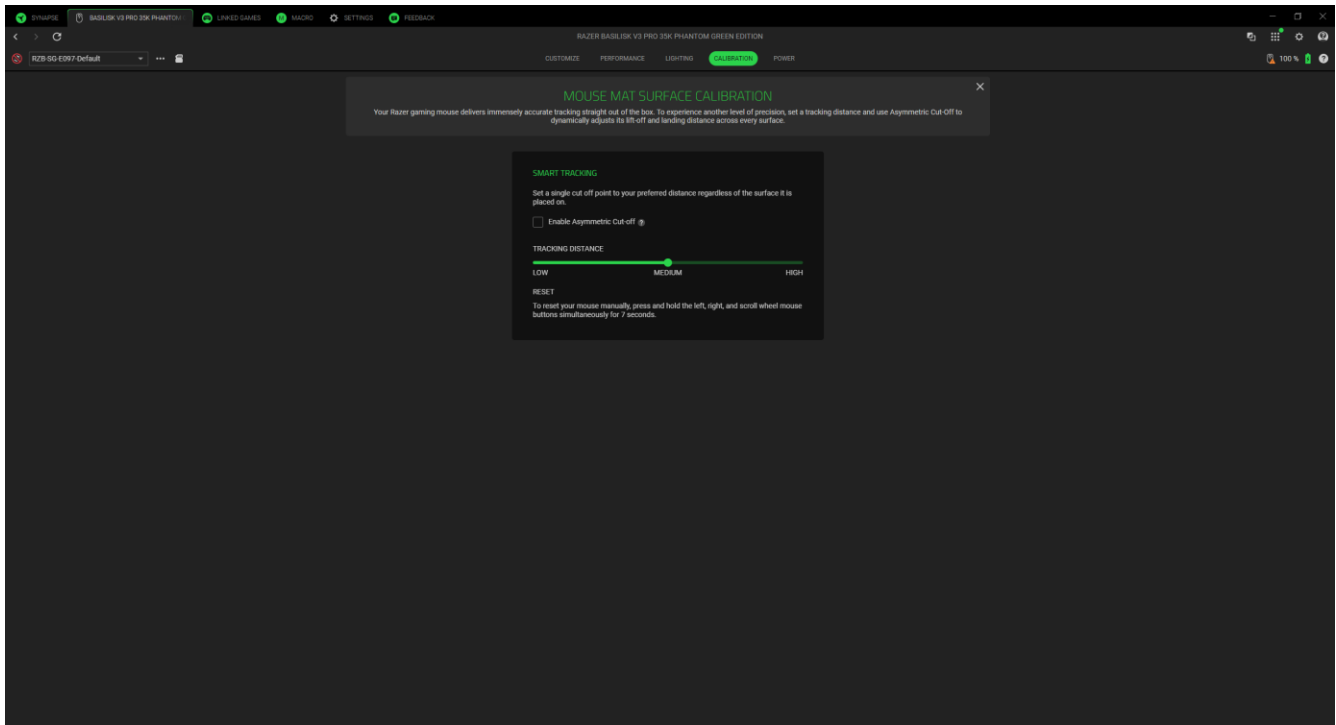

Smart Tracking

Smart Tracking lets you set the distance at which the sensor stops tracking when it is lifted from its surface to avoid unwanted cursor movement.

Enable Asymmetric Cut-Off

By selecting the Enable Asymmetric Cut-Off option, you may set different values for the lift-off and landing distances. Please ensure that you test these distances thoroughly, as setting them too low may cause compatibility issues with the surface.

Tracking Distance

Adjust the slider to set the specific vertical height at which the sensor stops tracking the mouse when it is lifted.

Power

The Power subtab allows you to manage your device's energy consumption when running on batteries. You can also set your device to enter sleep mode when it has been idle for a certain amount of time.

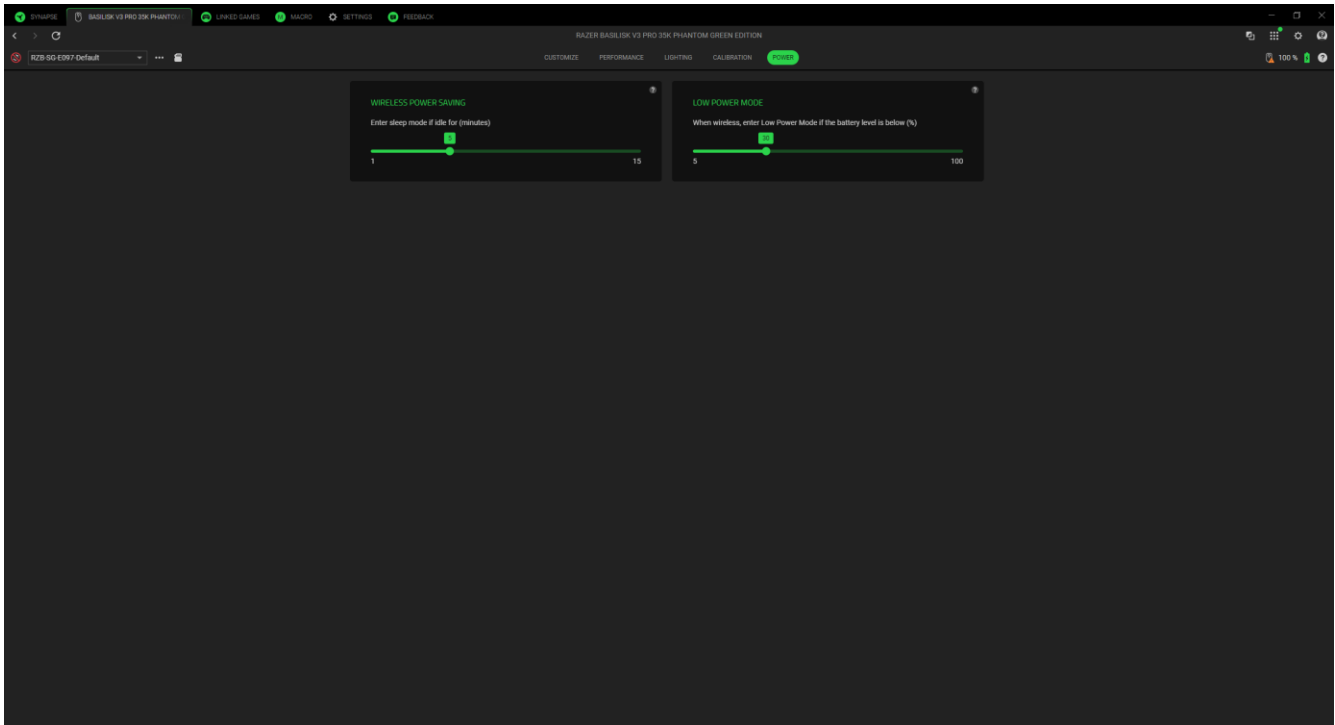

LINKED GAMES

The Linked Games tab allows you to add apps, view peripherals linked to apps, or search for listed apps.

Games

The Games subtab enables you to link apps to your peripherals. You can also sort apps based on alphabetical order, last played, or most played. Apps will still be listed here, even if not linked to a Razer device. To add an app that is not listed on the screen, you can use the Add button (+) to search for it manually or use the Scan button (🔍) to search for it automatically. Click the Search button (🔍) to look for a specific game or program from the list.

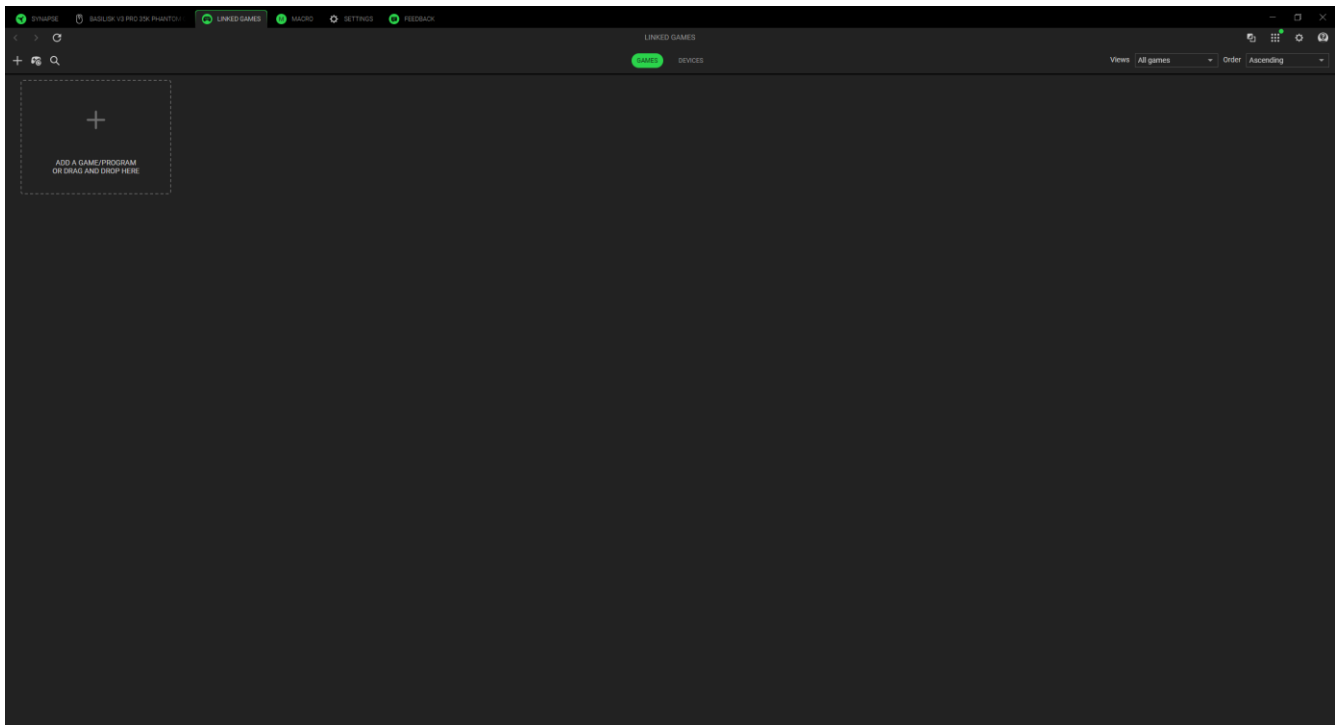

To link an app to your Razer device, click on it from the list and select a device and its profile. This will automatically set your device to the selected profile whenever you launch the app.

Devices

The Devices subtab lets you view your peripherals and determine which apps are linked to them. By selecting a device, you can see a list of linked apps, add new apps, or remove linked apps. You can filter these apps by using the Views and Order dropdown list. To add an app not listed on your peripheral, you can drag and drop the executable file inside the box or use the Add button (+) to open the search window. While inside the search window, you can click the Refresh button (↻) to rescan installed apps, the Search button (🔍) to look for a specific game or program from the list, or the Browse link to search for the app manually.

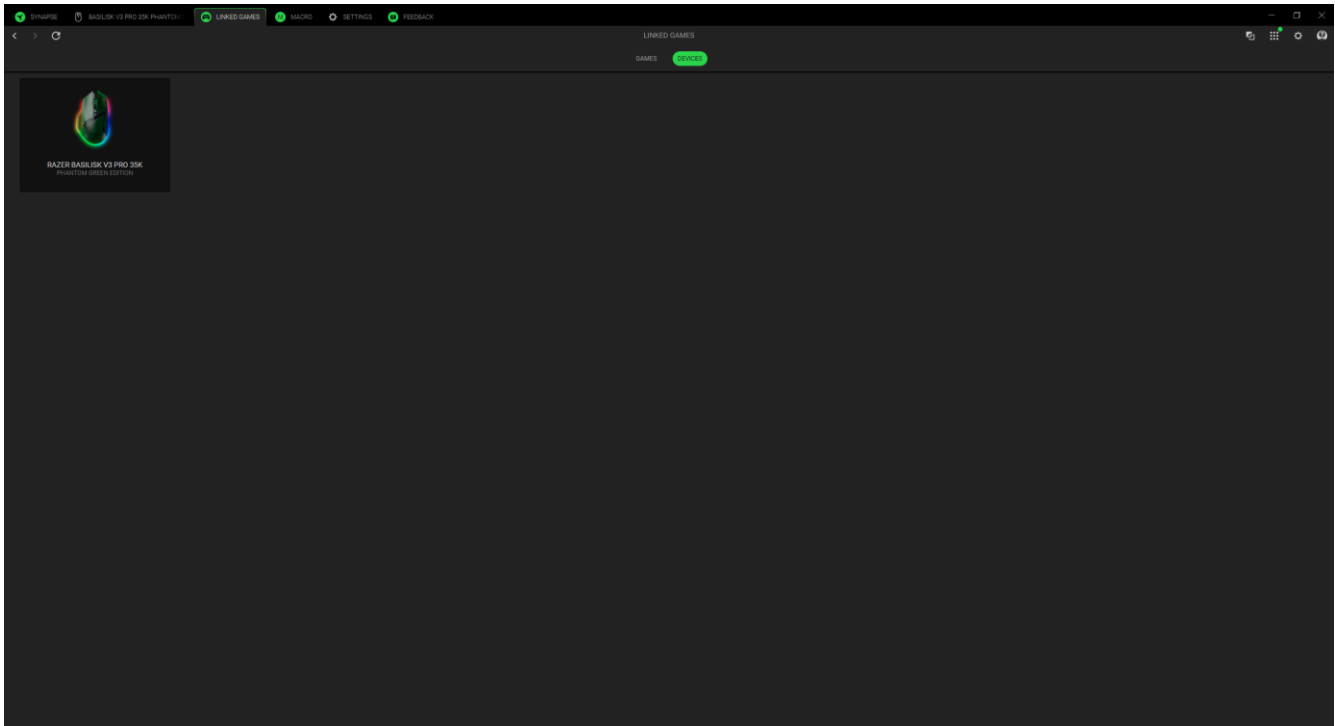

To link an app to your Razer device, click the tick box at the top left corner of the app while inside the search box. This will automatically set your device to the selected profile whenever you launch the app.

MACRO

If you need to execute a series of complex commands accurately, you need a macro. A macro is a set of recorded keystrokes, button presses, and cursor movements. that you can bind to your device and execute at any time.

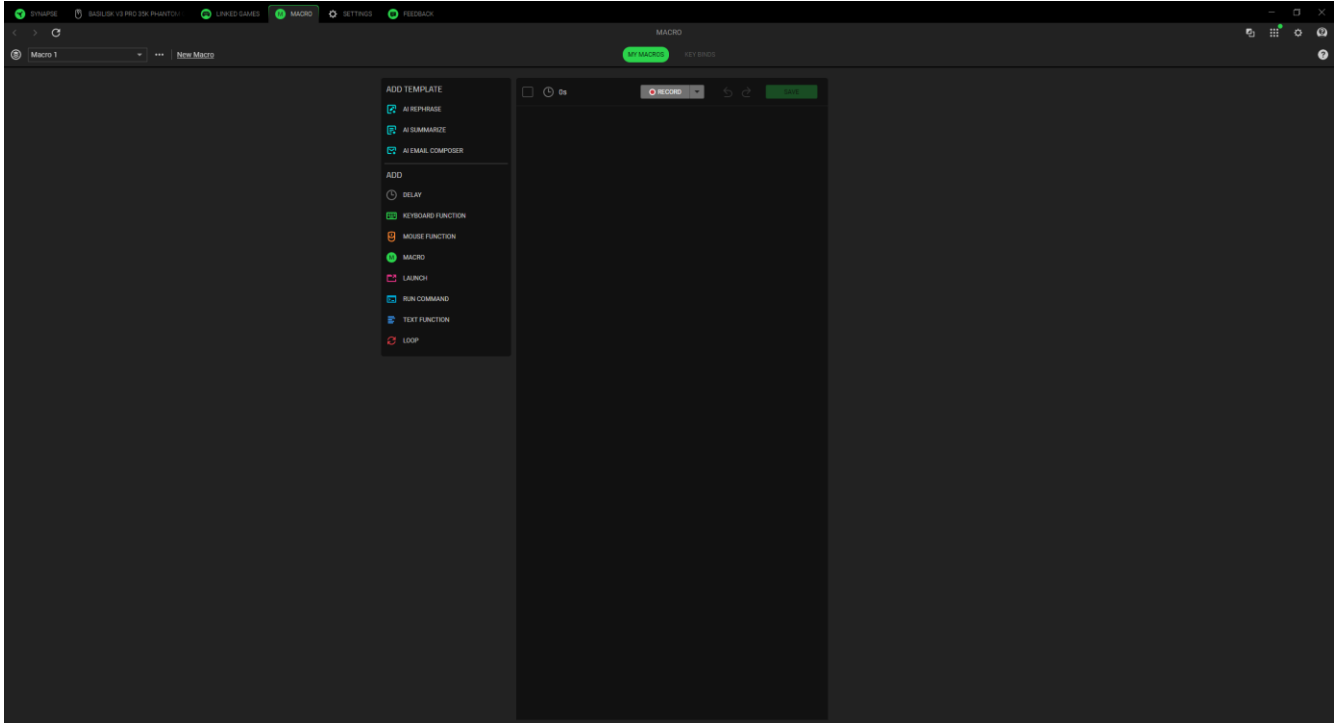

My Macros

The My Macros subtab allows you to create, edit, and organize these macros to assign them to your Razer device's keys or buttons. Use the following buttons below to access your macro options:

Macro Dropdown Bar



Clicking this dropdown bar will display all the macros for this device. From here, you can search for a specific macro, sort your macros, create a new folder, and create a new macro. Selecting a macro will enable miscellaneous options such as renaming, duplicating, or deleting the macro.

*** Miscellaneous

Clicking this button will open a pop-up with options related to your current macro.

New Macro

Use this link to create and select the new macro quickly.

Once you have a macro, you can record keystrokes, button presses, and cursor movements. by clicking the Record button () or you can customize the macro by clicking the dropdown menu button () before you start recording with the following options below:

- **Start Delay.** Set a short delay between 1 and 5 seconds before the recording starts.
- **Shortcut Key.** Assign a shortcut key to start a macro recording even when Razer Synapse is in the background.
- **Delay Settings.** Set the amount of time between each command.
- **Mouse Movement Tracking.** Enable mouse movement recording and set conditions for how it is recorded.

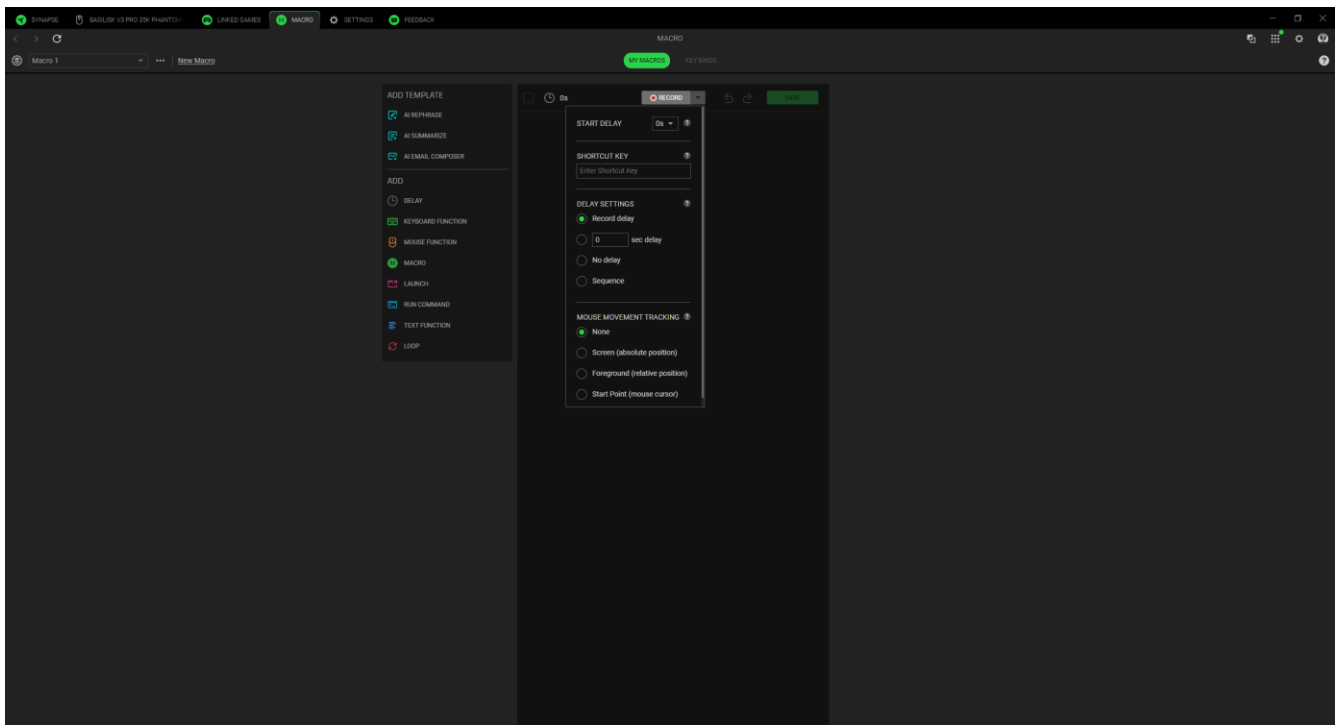

After recording your macro commands, click the Stop button () or press the Shortcut key to end the session. Once you have recorded a macro, you may edit the commands you have entered by selecting each command on the macro screen. Each keystroke or button press is arranged sequentially, with the first command at the top of the screen.

The Insert menu on the left side of the screen allows you to add delays, input keystrokes and button presses, insert an entire macro group within the macro, launch apps, run commands, type texts, and loop a set of commands within the macro.

Key Binds

The Key Binds subtab allows you to view the Shortcut Keys for the selected macro. You can bind a macro to the key or button of your choice without leaving the Macro tab by clicking the Assign Macro To Your Devices button (+).

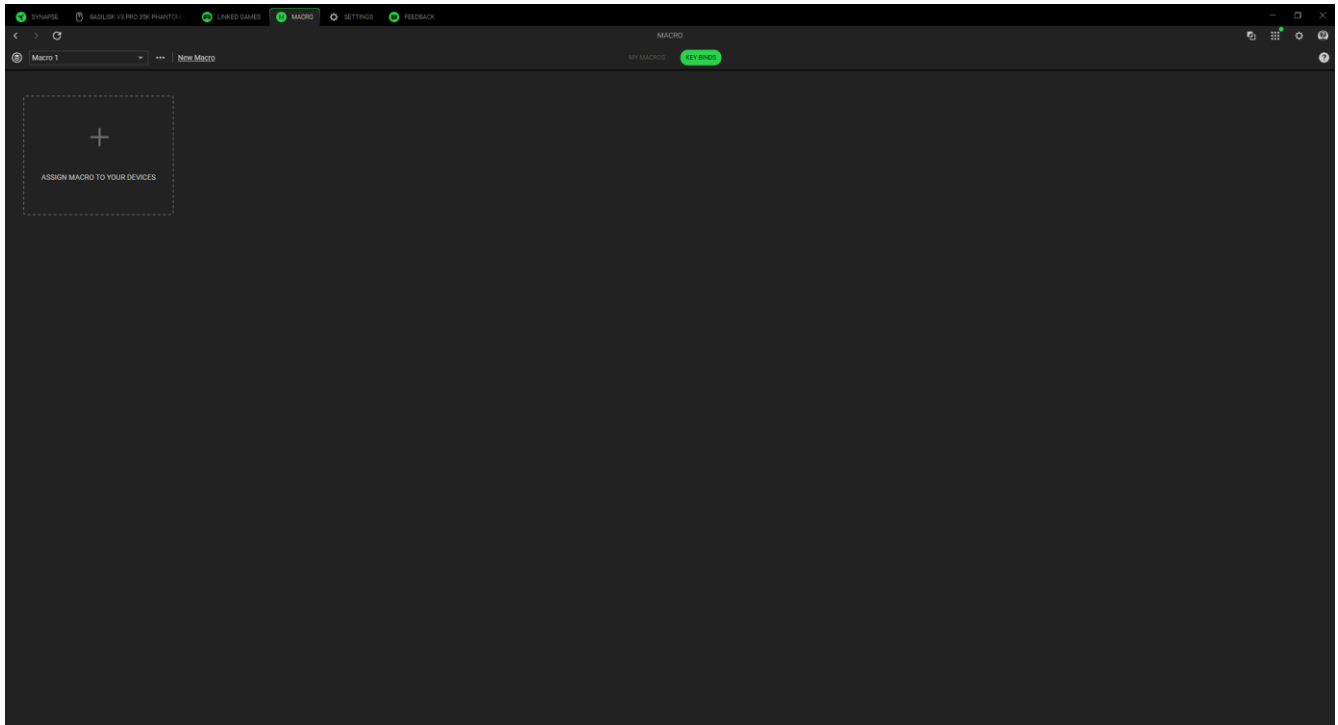

SETTINGS

The Settings tab, accessible by clicking the (⚙) button, enables you to configure numerous options as listed below:

Synapse

The Synapse subtab is where you can find options that are specific to the app.

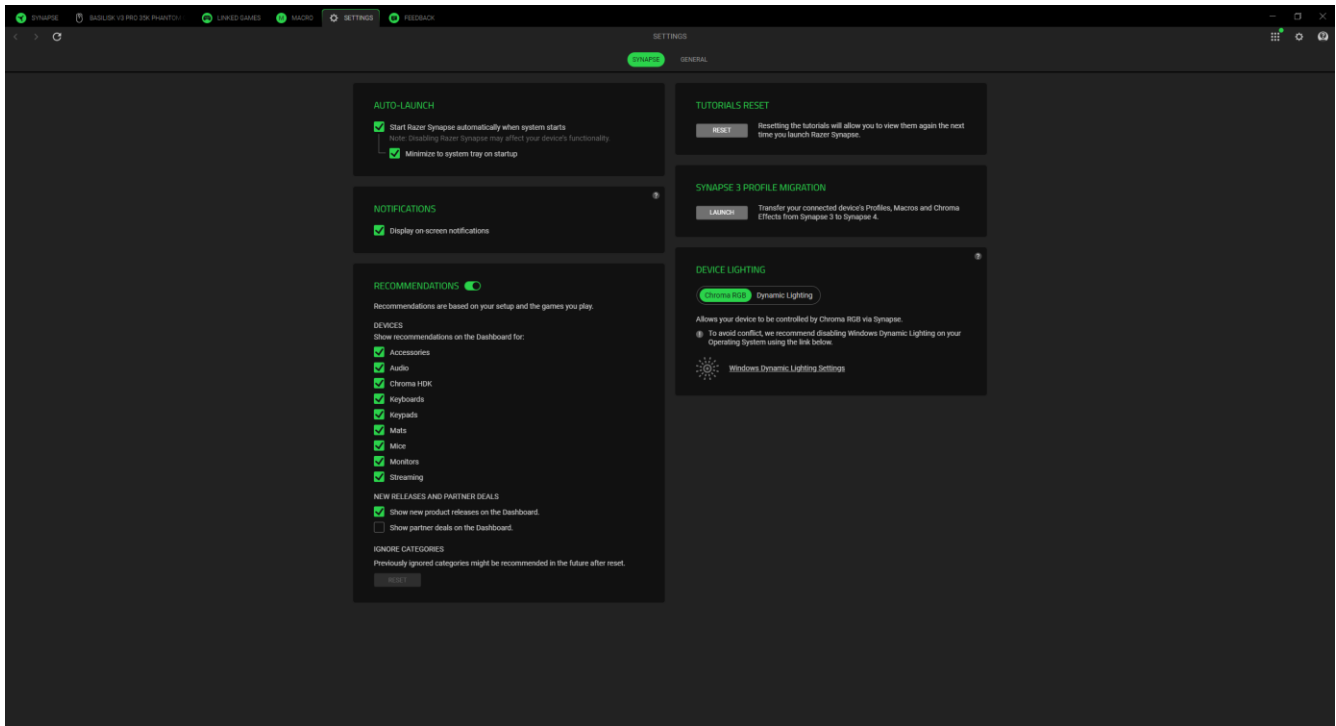

Auto Launch

The Auto Launch option allows you to configure the startup behavior the app.

Notifications

The Notifications option allows the app to display on-screen notifications even if you run full-screen apps.

Recommendations

Recommendations enable us to show the latest products and features on your Dashboard based on your installed devices and linked games.

Tutorials Reset

Selecting the Reset button will reactivate all tutorials that help you acquaint yourself with Razer Synapse's features.

Profile Migration

This function lets you transfer all your device's Profiles, Macros, and Chroma Effects from Synapse 3 to the new Synapse.

Device Lighting

This option lets you choose which app will control the lighting effects on your device.

General

The General subtab is the section where you can access miscellaneous options for your app, as well as find additional information about the software.

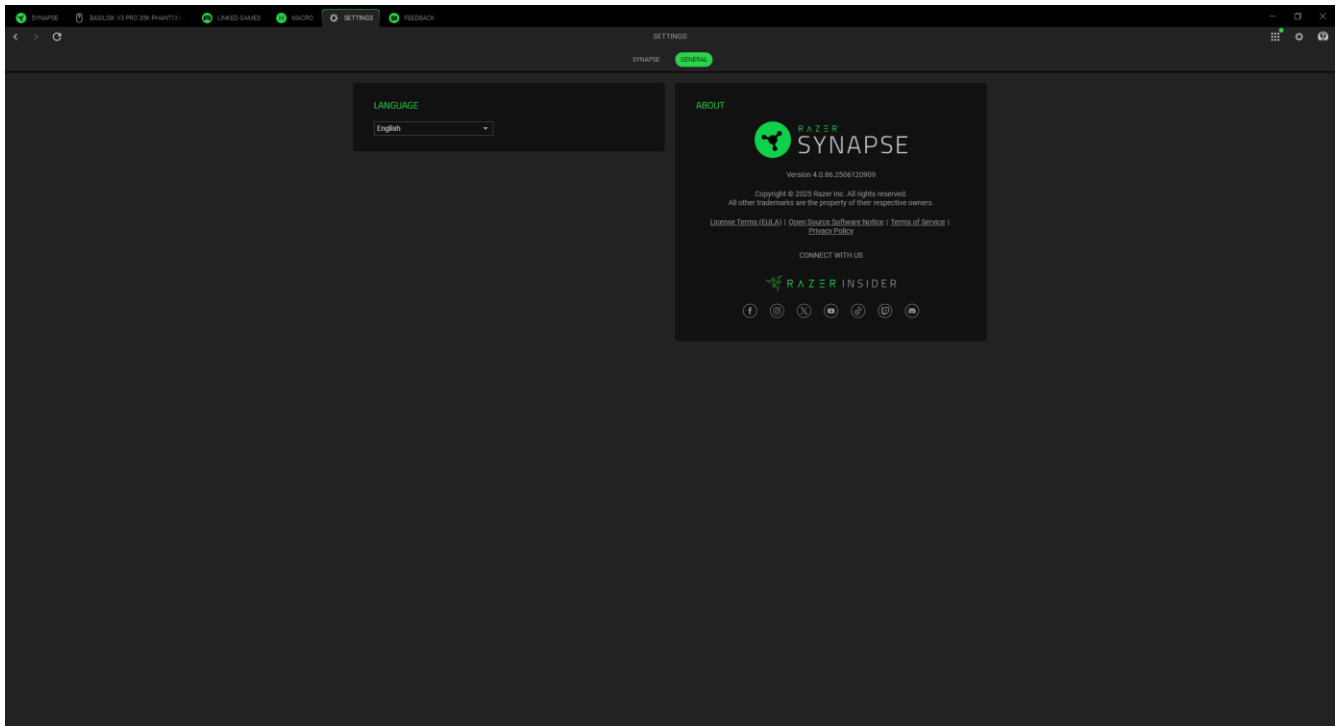

Language

This option lets you change the display language of Razer Synapse.

About

The About section shows the current software version, displays the copyright statement, and provides relevant links for Razer's terms of use. You may also use this option to access Razer's social communities quickly.

FEEDBACK

Help us improve Razer Synapse by giving your comments, suggestions, and problems with the software. You can contact us directly using this tab and even earn rewards for reporting bugs.

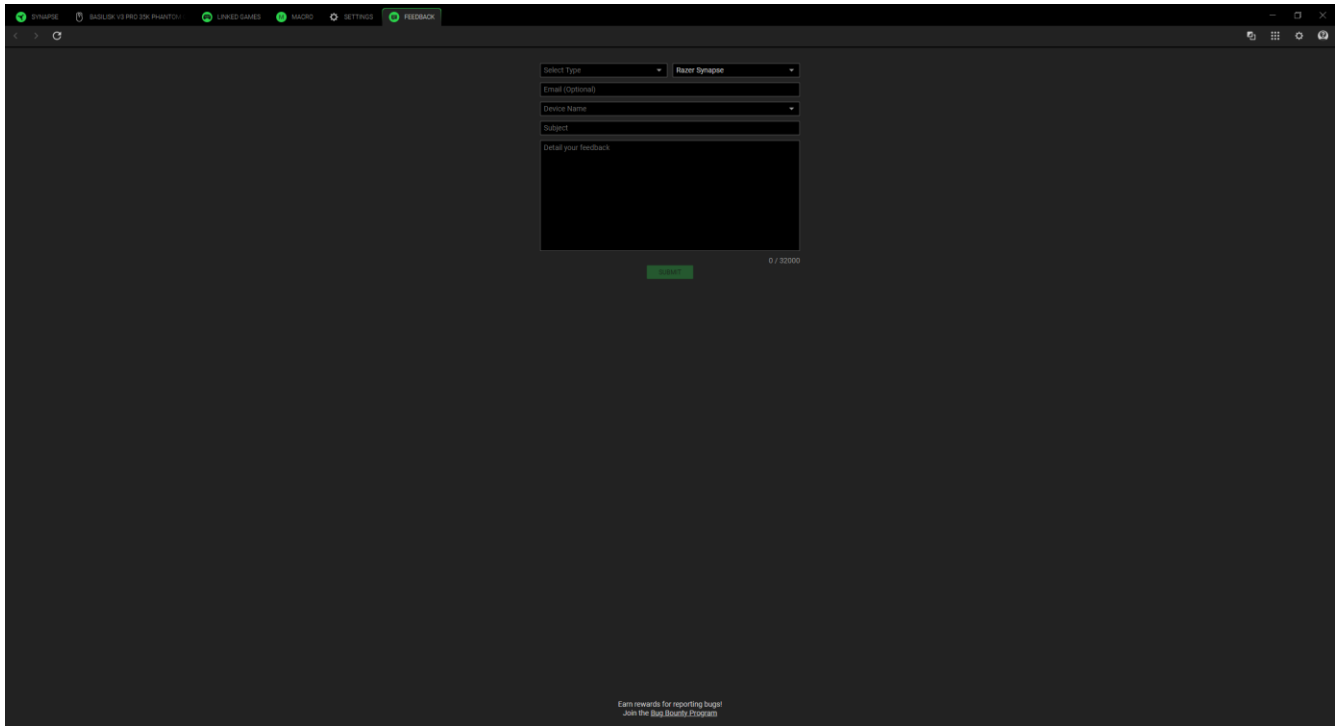

The screenshot shows the Razer Synapse Feedback interface. At the top, there is a navigation bar with tabs for SYNAPSE, RAZER V3 PRO DR. HEDDSE, LINKED GAMES, MACRO, SETTINGS, and FEEDBACK. The FEEDBACK tab is active. The form contains the following fields:

- Select Type: Razer Synapse
- Email (Optional):
- Device Name:
- Subject:
- Detail your feedback:

At the bottom right of the form, there is a character count: 0 / 50000. Below the form, there is a green button labeled "Submit". At the bottom center of the page, there is a small text link: "Earn rewards for reporting bugs! Join the Bug Bounty Program".

7. SAFETY AND MAINTENANCE

SAFETY GUIDELINES

In order to achieve maximum safety while using your Razer Basilisk V3 Pro 35K, we suggest that you adopt the following guidelines:

Should you have trouble operating the device properly and troubleshooting does not work, unplug the device and contact the Razer hotline or go to support.razer.com for support.

Do not take apart the device (doing so will void your warranty) and do not attempt to operate it under abnormal current loads.

Keep the device away from liquid, humidity or moisture. Operate the device only within the specific temperature range of 0°C (32°F) to 40°C (104°F). Should the temperature exceed this range, unplug and/or switch off the device in order to let the temperature stabilize to an optimal level.

Avoid looking directly at the tracking beam of your mouse or pointing the beam in anyone else's eye. Note that the tracking beam is NOT visible to the naked human eye and is set on an Always-On mode.

COMFORT

Research has shown that long periods of repetitive motion, improper positioning of your computer peripherals, incorrect body position, and poor habits may be associated with physical discomfort and injury to nerves, tendons, and muscles. Below are some guidelines to avoid injury and ensure optimum comfort while using your Razer Basilisk V3 Pro 35K.

- Position your keyboard and monitor directly in front of you with your mouse next to it. Place your elbows next to your side, not too far away and your keyboard within easy reach.
- Adjust the height of your chair and table so that the keyboard and mouse are at or below elbow-height.
- Keep your feet well supported, posture straight and your shoulders relaxed.
- During gameplay, relax your wrist and keep it straight. If you do the same tasks with your hands repeatedly, try not to bend, extend or twist your hands for long periods.
- Do not rest your wrists on hard surfaces for long periods. Use a wrist rest to support your wrist while gaming.
- Customize the keys on your keyboard to suit your style of gaming in order to minimize repetitive or awkward motions while gaming.

- Do not sit in the same position all day. Get up, step away from your desk and do exercises to stretch your arms, shoulders, neck and legs.

If you should experience any physical discomfort while using your mouse, such as pain, numbness, or tingling in your hands, wrists, elbows, shoulders, neck or back, please consult a qualified medical doctor immediately.

MAINTENANCE AND USE

The Razer Basilisk V3 Pro 35K requires minimum maintenance to keep it in optimum condition. Once a month we recommend you unplug the device from the computer and clean it using a soft cloth or cotton swab to prevent dirt buildup. Do not use soap or harsh cleaning agents.

To get the ultimate experience in movement and control, we highly recommend a premium mouse mat from Razer. Some surfaces will cause undue wear on the feet requiring constant care and eventual replacement.

Do note that the sensor of the Razer Basilisk V3 Pro 35K is 'tuned' or optimized especially for the Razer mouse mats. This means that the sensor has been tested extensively to confirm that the Razer Basilisk V3 Pro 35K reads and tracks best on Razer mouse mats.

8. LEGALESE

COPYRIGHT AND INTELLECTUAL PROPERTY INFORMATION

©2025 Razer Inc. All rights reserved. Razer, the triple-headed snake logo, Razer logo, “For Gamers. By Gamers.” and “Razer Chroma” are trademarks or registered trademarks of Razer Inc. and/or affiliated companies in the United States and other countries. Actual product may differ from pictures. All other trademarks are the property of their respective owners. Warranty not valid outside of product’s intended region.

Windows and the Windows logo are trademarks of the Microsoft group of companies.

Razer Inc. (“Razer”) may have copyright, trademarks, trade secrets, patents, patent applications, or other intellectual property rights (whether registered or unregistered) concerning the product in this guide. Furnishing of this guide does not give you a license to any such copyright, trademark, patent or other intellectual property right. The Razer Basilisk V3 Pro 35K (the “Product”) may differ from pictures whether on packaging or otherwise. Razer assumes no responsibility for such differences or for any errors that may appear. Information contained herein is subject to change without notice.

LIMITED PRODUCT WARRANTY

For the latest and current terms of the Limited Product Warranty, please visit razer.com/warranty.

LIMITATION OF LIABILITY

Razer shall in no event be liable for any lost profits, loss of information or data, special, incidental, indirect, punitive or consequential or incidental damages, arising in any way out of distribution of, sale of, resale of, use of, or inability to use the Product. In no event shall Razer’s liability exceed the retail purchase price of the Product.

GENERAL

These terms shall be governed by and construed under the laws of the jurisdiction in which the Product was purchased. If any term herein is held to be invalid or unenforceable, then such term (in so far as it is invalid or unenforceable) shall be given no effect and deemed to be excluded without invalidating any of the remaining terms. Razer reserves the right to amend any term at any time without notice.