



RAZER NOMMO V2 PRO

MASTER GUIDE

Experience absolute power and precision that blows you away with the **Razer Nommo V2 Pro**—a fully-loaded, full-range speaker system and wireless subwoofer combo. Amplified by THX® Spatial Audio and Razer Chroma™ RGB, set the stage for a cinematic audio-visual experience primed for your battlestation.

CONTENTS

1. WHAT'S INSIDE	3
2. WHAT'S NEEDED	7
3. LET'S GET YOU COVERED.....	8
4. TECHNICAL SPECIFICATIONS	9
5. SETTING UP YOUR RAZER NOMMO V2 PRO	10
6. CONNECTING TO YOUR GAMING SPEAKERS	13
7. USING YOUR GAMING SPEAKERS.....	17
8. CONFIGURING YOUR RAZER NOMMO V2 PRO VIA RAZER SYNAPSE.....	24
9. SAFETY AND MAINTENANCE	36
10. LEGALESE.....	37

1. WHAT'S INSIDE

- Razer Nommo V2 Pro



- A. Rear projection Razer Chroma™ RGB lighting
- B. USB Type C port
- C. Power port
- D. Left speaker port
- E. Left speaker connector

- Wireless subwoofer

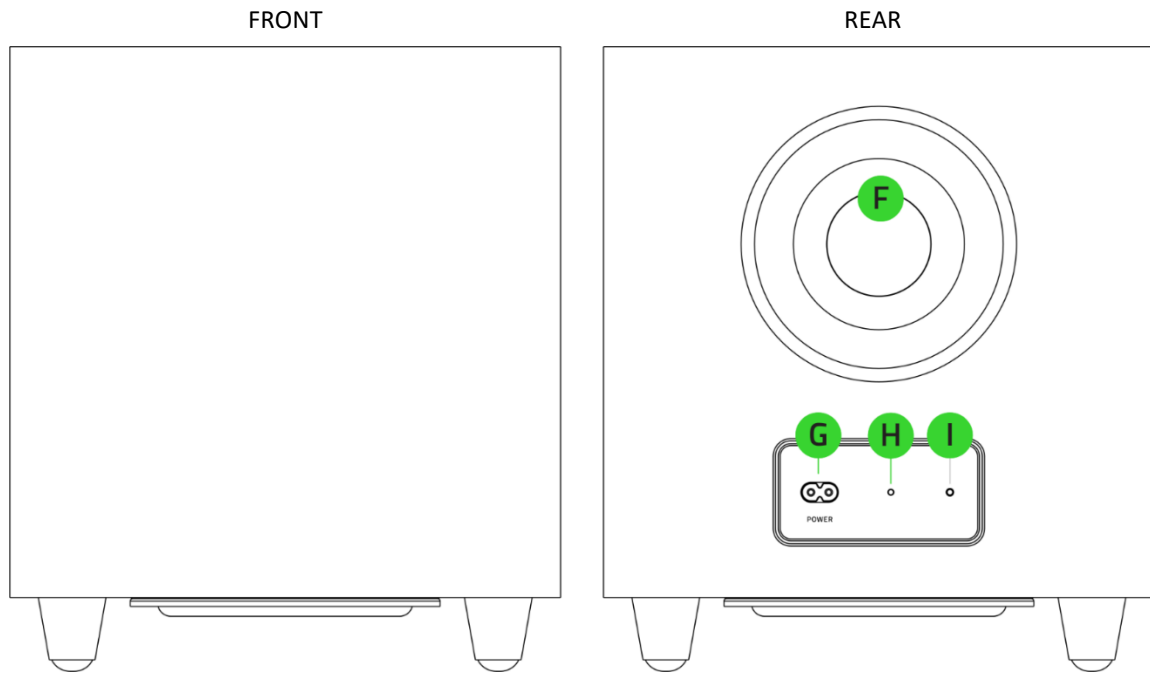

- F. Rear-facing bass port
- G. Power port

- H. Subwoofer pairing button
- I. Subwoofer status indicator

- Razer Wireless Control Pod

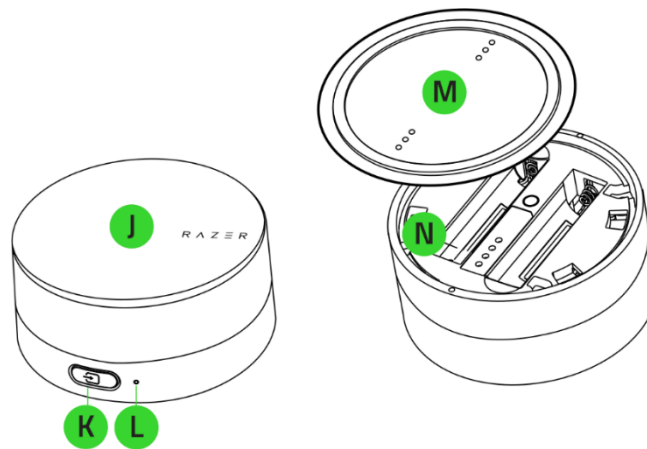

- J. Power button / Media control knob
- K. Source button
- L. Status indicator

- M. Bottom cover
- N. Battery compartment

- USB Type A to USB Type C cable

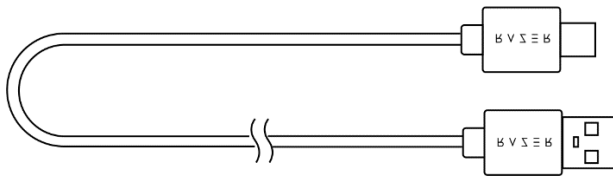

- Power adapter for speakers + regional plugs*

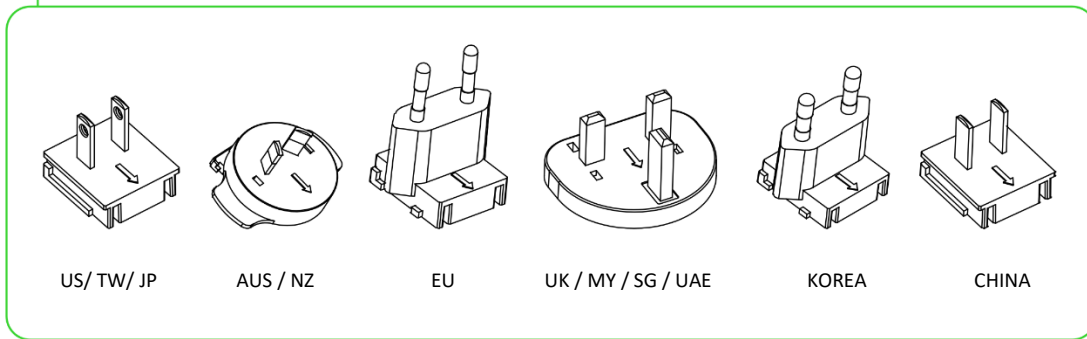
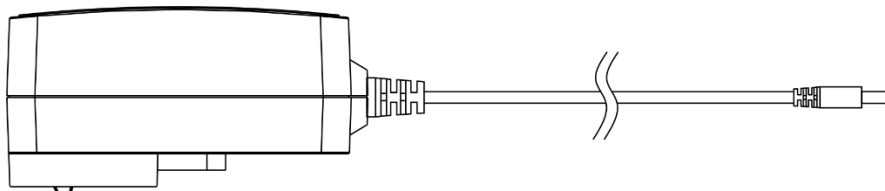

- Subwoofer regional power cords*

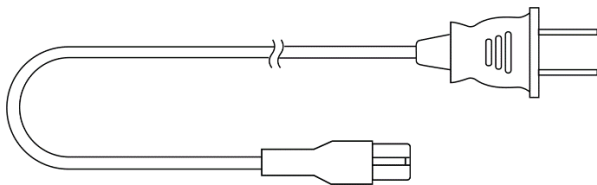

- 2 x AAA batteries

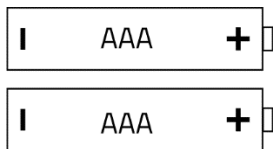

- Important Product Information Guide

**May vary for specific regions.*

2. WHAT'S NEEDED

PRODUCT REQUIREMENTS

- USB Type A port or devices with Bluetooth connectivity
- 2 x AAA batteries*

RAZER SYNAPSE REQUIREMENTS

- Windows® 10 64-bit (or higher)
- Internet connection for software installation

**Required for the Razer Wireless Control Pod.*

3. LET'S GET YOU COVERED



Register your product and score exclusive benefits

razerid.razer.com/warranty

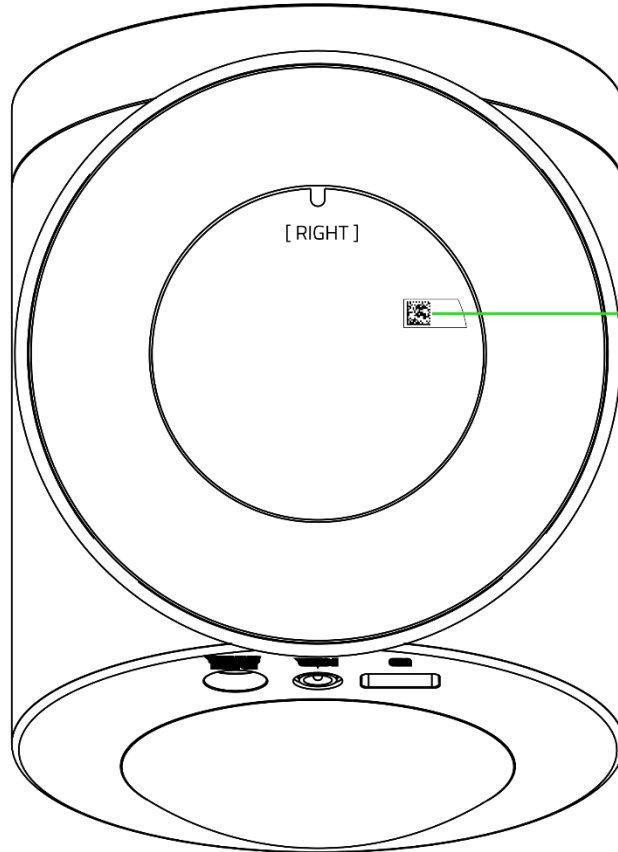

Your product's serial number can be found here.

4. TECHNICAL SPECIFICATIONS

TECHNICAL SPECIFICATIONS

- Razer Chroma™ RGB (Rear projection zones)
- THX® Spatial Audio
- Bluetooth 5.3
- USB audio input
- Wireless subwoofer
- Customizable EQ
- Frequency response: 40 Hz – 20 kHz
- Max SPL: 99 dB at 1 meter
- Input power: External power adapter
- Driver type: Full-range drivers with aluminum phase plugs and subwoofer driver
- Driver specifications:
 - Full range drivers: 2 x 3.2" / 83 mm
 - Subwoofer driver: 1 x 5.5" / 140 mm

CONNECTIVITY

- Bluetooth connection
- USB Type C to USB Type A
- Toggle PC audio devices (supported via Razer Synapse)
- Cable length:
 - USB Type C to USB Type A cable: 2 m
 - Speaker cable: 2 m
 - Power cord for speakers: 2 m
 - Power cord for subwoofer: 2 m

5. SETTING UP YOUR RAZER NOMMO V2 PRO

1. Connect the left speaker connector to the left speaker port on the right speaker.

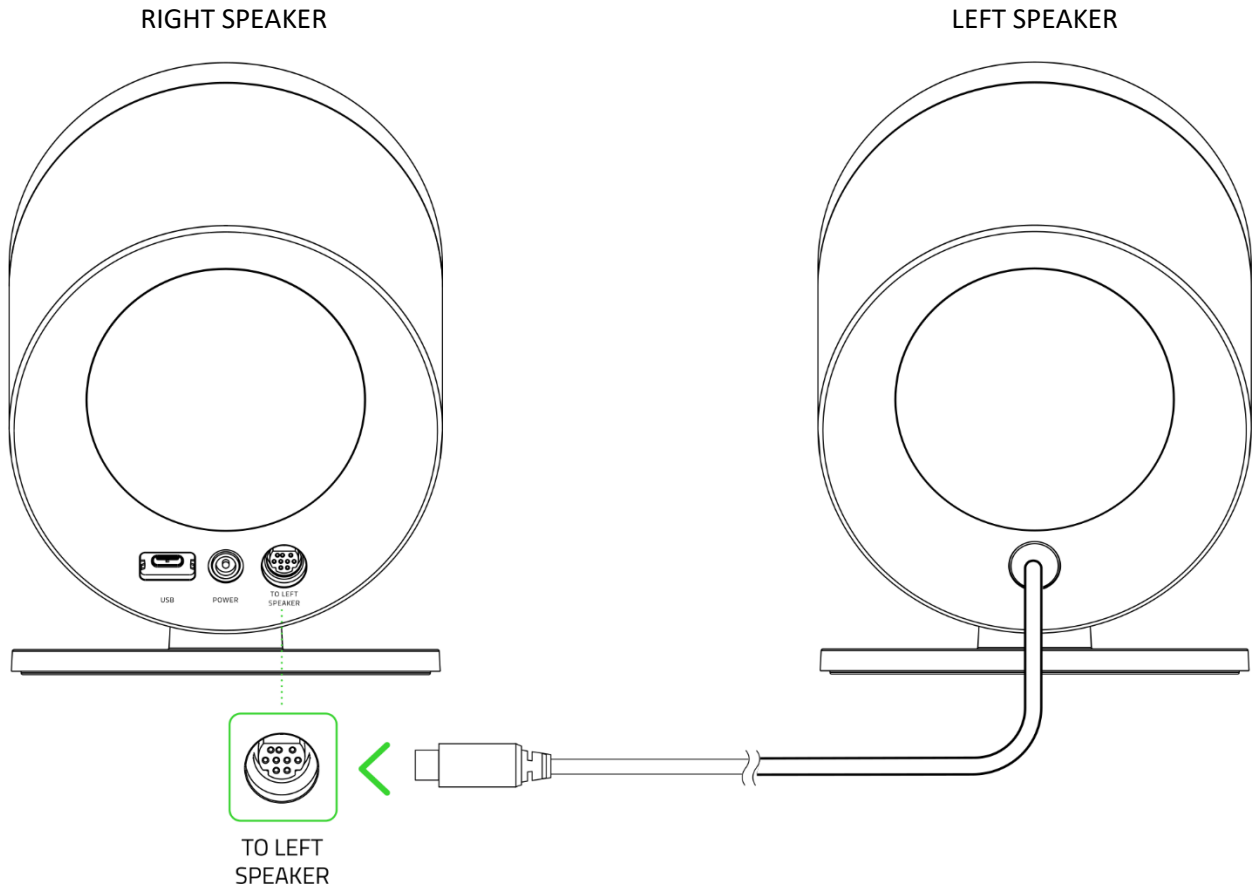

- !** Before connecting the left speaker connector, align its pins correctly to the left speaker port. **DON'T FORCEFULLY PLUG** the left speaker connector into the left speaker port.

2. With the appropriate AC plug for your region attached to the power adapter, connect it to the power port on the right gaming speaker and plug it into a power outlet.

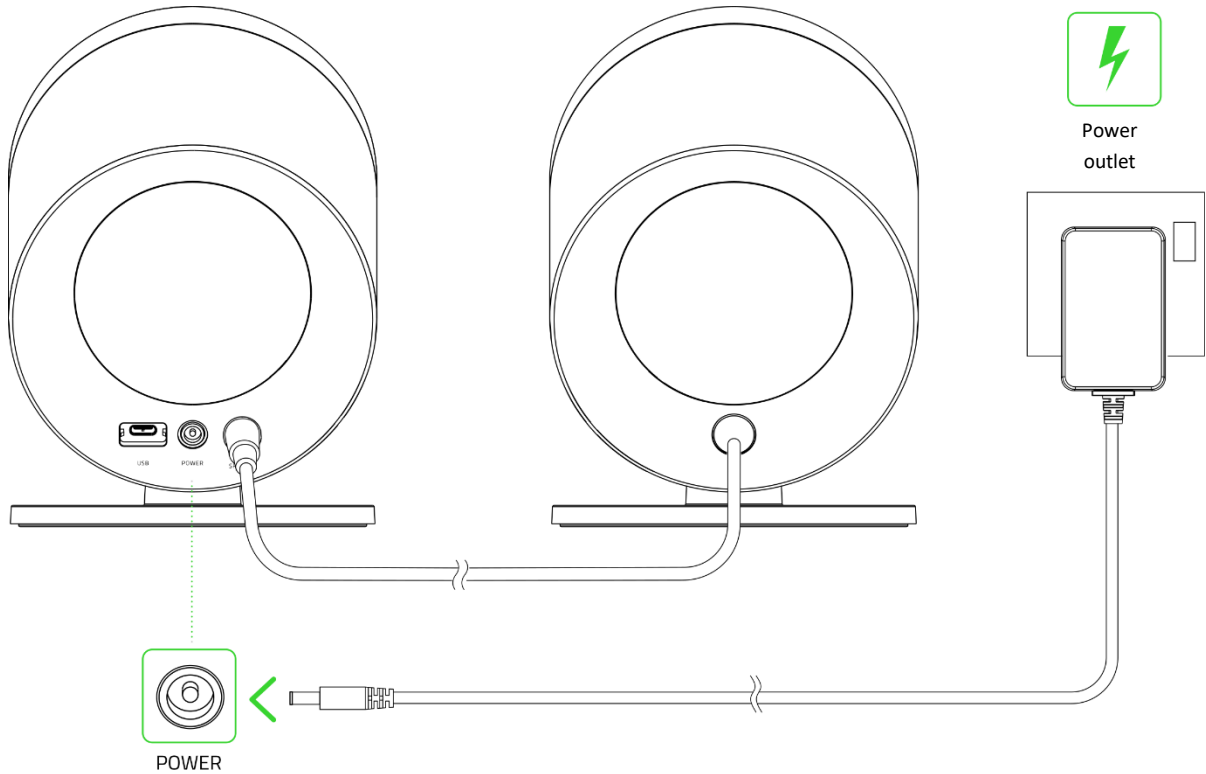

3. Connect the regional power cord to the power port on the subwoofer and plug it into a power outlet.

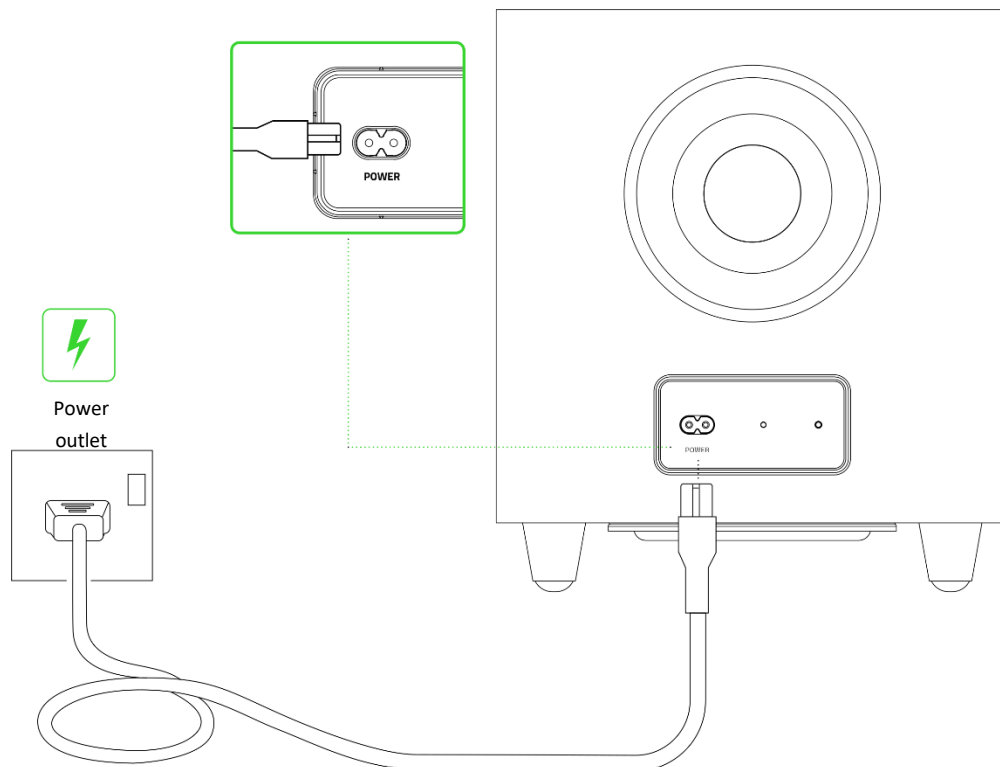

 Use the appropriate power cord for your region.

4. Rotate the bottom cover to detach and insert the AAA batteries as indicated in the battery compartment.

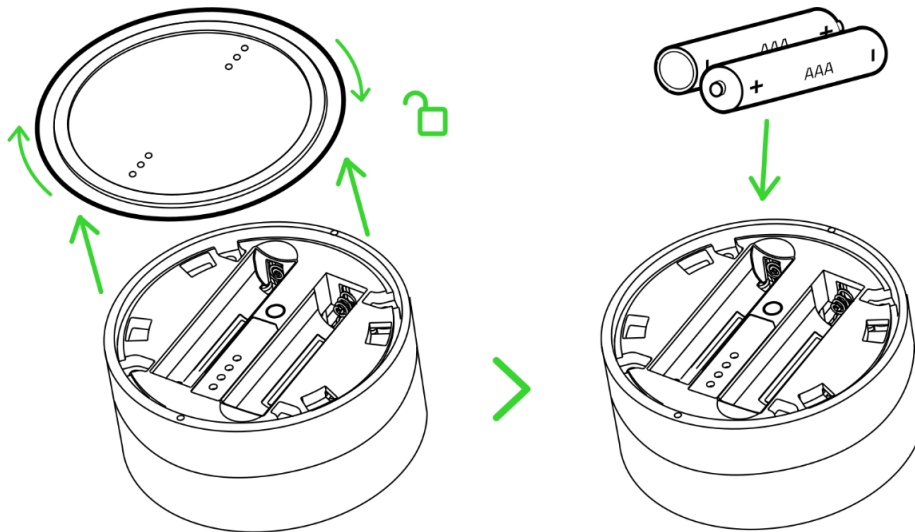

Caution: The included AAA batteries are non-rechargeable. Dispose of batteries in accordance with your local environmental laws. For your safety, use only lithium or alkaline batteries.

5. Reattach and rotate the bottom cover to lock it in place.

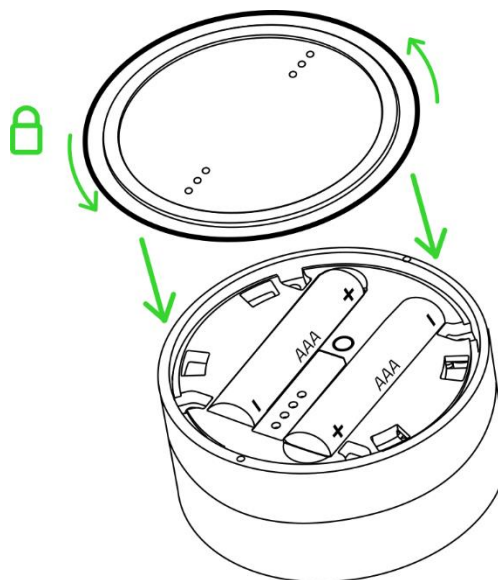

6. CONNECTING TO YOUR GAMING SPEAKERS

A. VIA PC MODE

1. Connect the gaming speakers to any of the USB Type A ports on your PC.

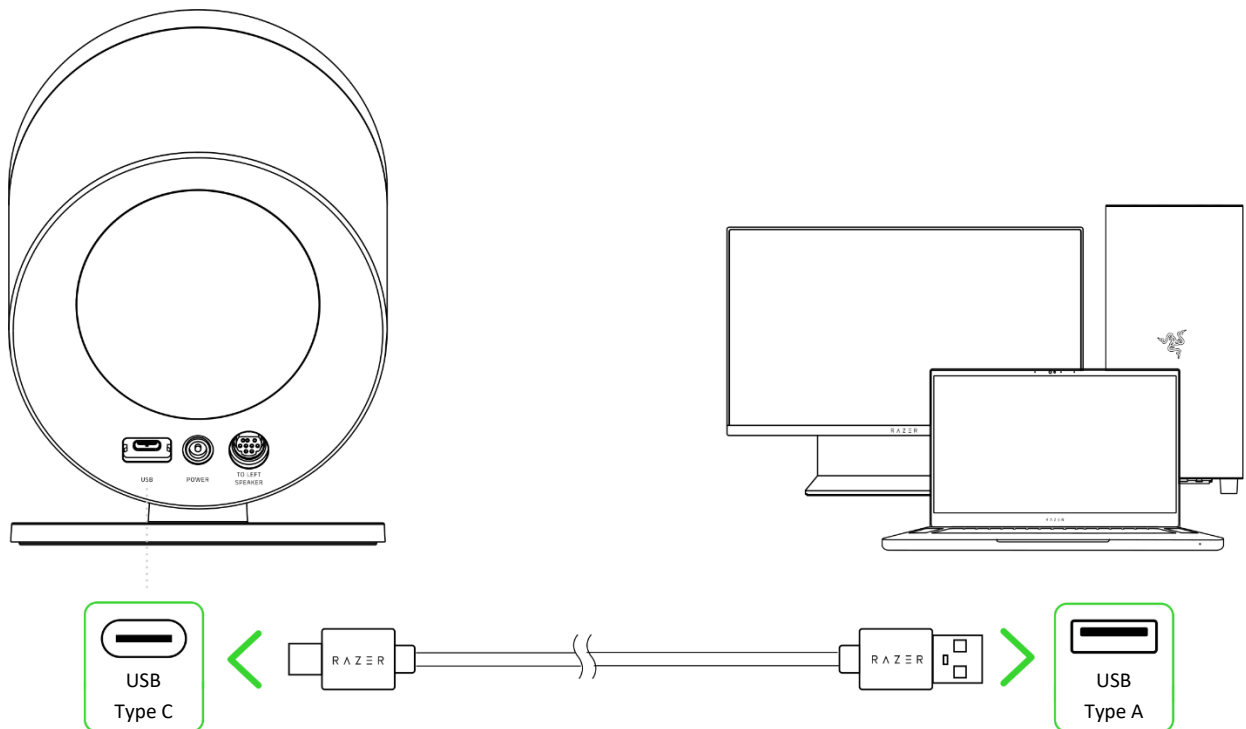

2. Press and hold the Power button on the control pod to power on the gaming speakers. The control pod's status indicator will turn white to indicate that it's connected to the gaming speakers, then turn solid green to indicate that the gaming speakers are in PC mode.

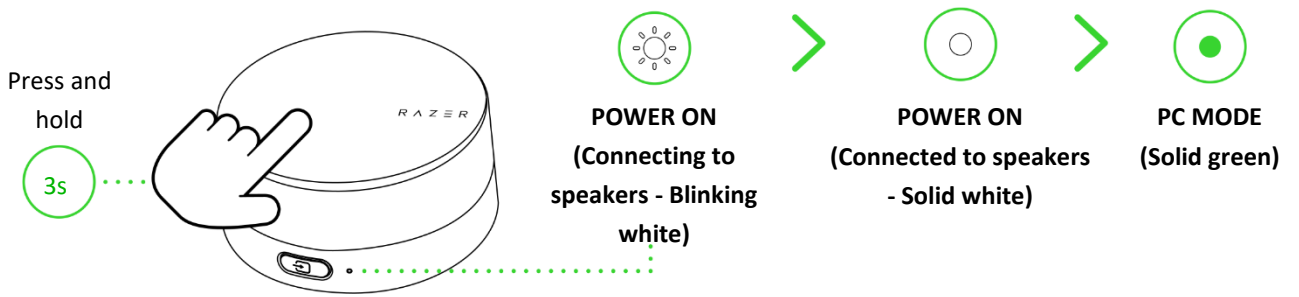

! *On PC mode, the gaming speakers' rear projection lighting will briefly light up in solid green and display the spectrum cycling (default) lighting effect.*

When powered on, the wireless subwoofer's status indicator will blink in green to indicate that it's connecting to the gaming speakers and turn solid green once connected.

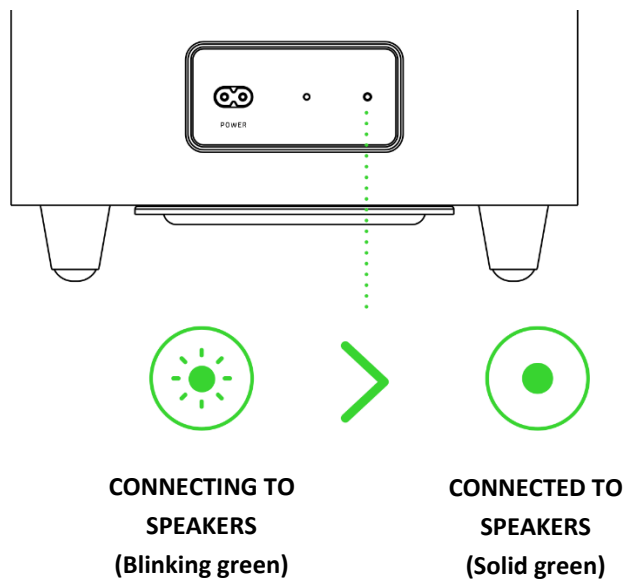

3. Set the **Razer Nommo V2 Pro** as the default **Output** device on your PC.

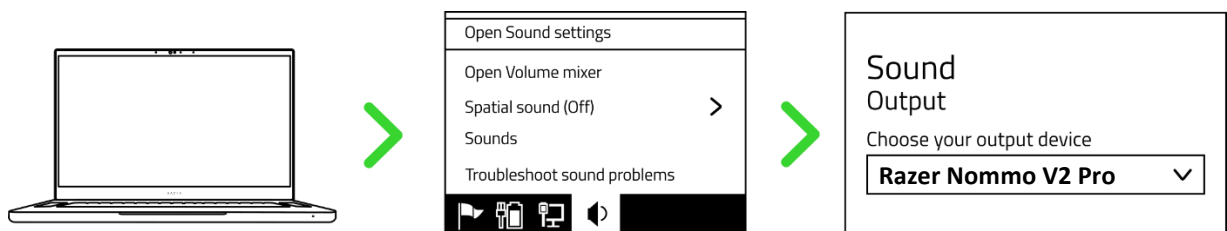

i *When using the gaming speakers with compatible devices, set the Razer Nommo V2 Pro as its default output device (if applicable).*

The Razer Nommo V2 Pro is now ready for use in PC mode.

B. VIA BLUETOOTH MODE

1. While powered on and in PC mode, press the Source button on the control pod to switch to Bluetooth mode. The status indicator on the control pod will blink in blue, and an audio prompt will be heard to indicate that the gaming speakers are in pairing mode.

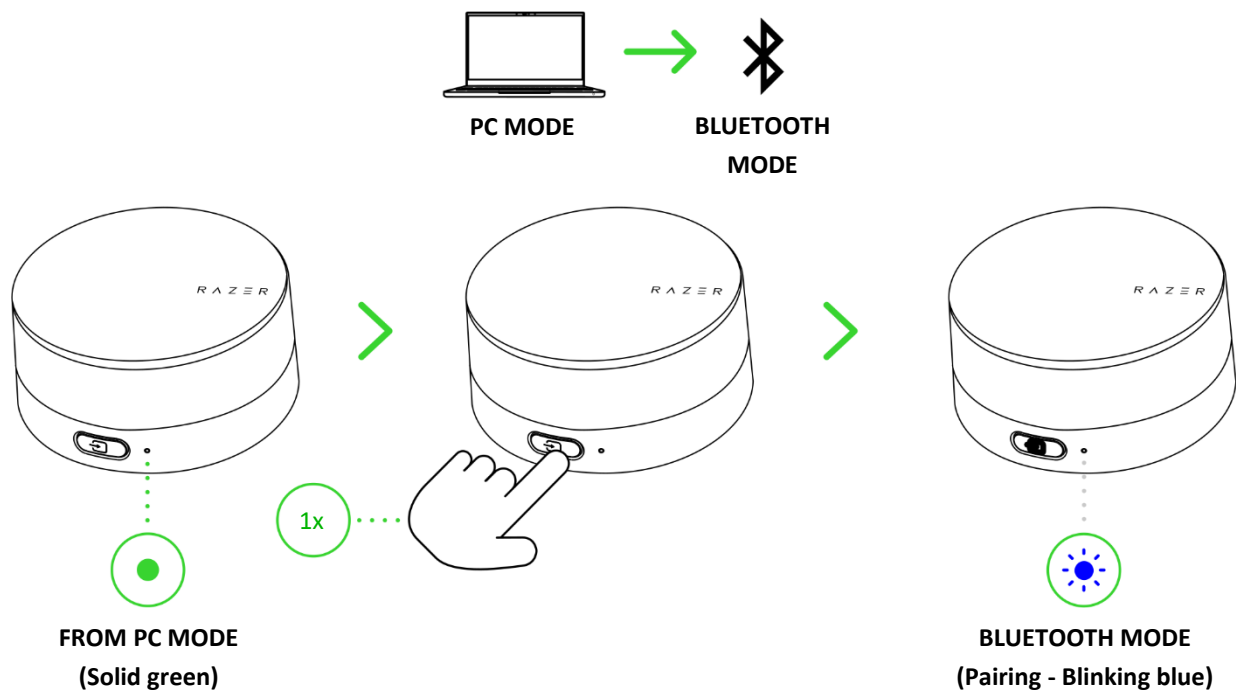

2. Activate Bluetooth on your device and select "**Razer Nommo V2 Pro (BT)**" from the available devices.



3. Wait until both devices are connected. The status indicator will turn solid blue to indicate that the gaming speakers are now connected to your device. In Bluetooth mode, the rear projection lighting will only light up according to your mobile device's current audio level (Audio reactive).

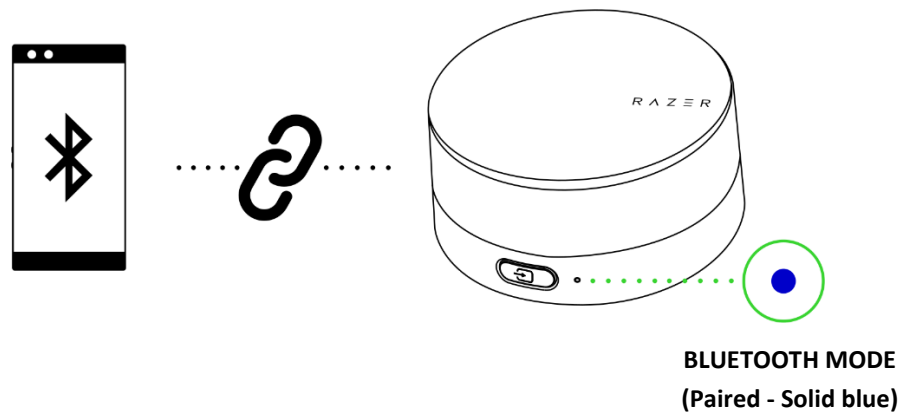

- ! *Instructions are for first-time pairing only. When connecting to your gaming speakers, remember to keep them within 1 meter of your mobile device. When connected via Bluetooth, Once paired, your gaming speakers will automatically reconnect to your mobile device whenever you switch to Bluetooth mode. [Learn more about switching between audio sources](#)*

The Razer Nommo V2 Pro is now ready for use in Bluetooth mode.

7. USING YOUR GAMING SPEAKERS

LOW BATTERY INDICATOR

The control pod's status indicator will blink red repeatedly to indicate that its batteries are less than 10%. This lighting sequence will repeat until the batteries are drained or replaced.

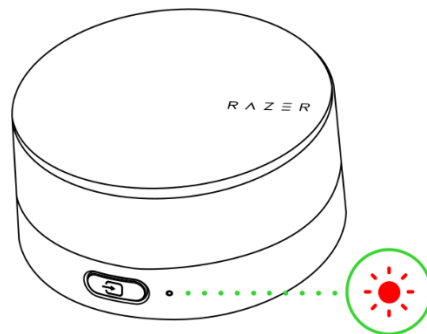

POWER ON/OFF

Press and hold the Power button on the control pod for 3 seconds to power on or off the gaming speakers. The status indicator will briefly light up in white when the gaming speakers are powered on before showing the current audio source.

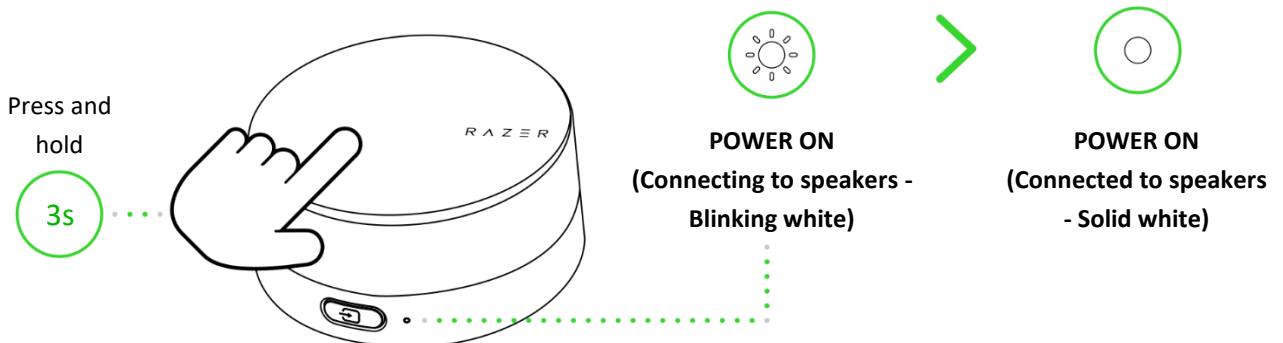

In PC mode, the rear projection lighting on the gaming speakers will briefly turn solid green when powered on or solid red when powered off.

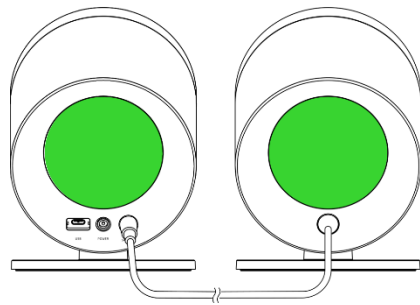

REAR PROJECTION LIGHTING
(Powered on - Solid green)

OR

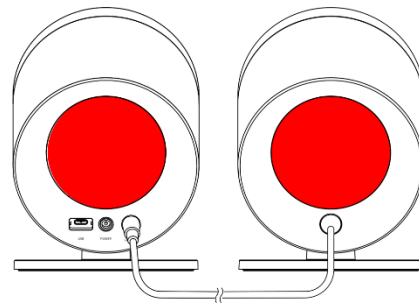

REAR PROJECTION LIGHTING
(Powered off - Solid red)

CONTROLLING MEDIA

Other media control functions below are available for the Power button:

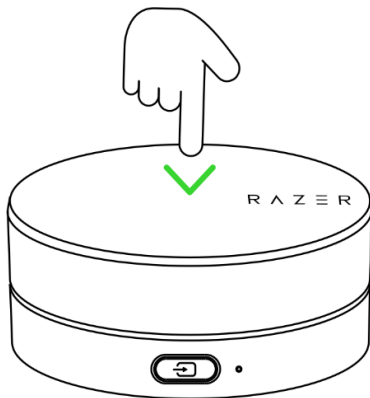

Single press	Mute / unmute audio
Double press	Play / pause a track
Triple press	Skip a track

ADJUSTING THE VOLUME

Rotate the Media control knob to adjust the volume of the current audio mode.

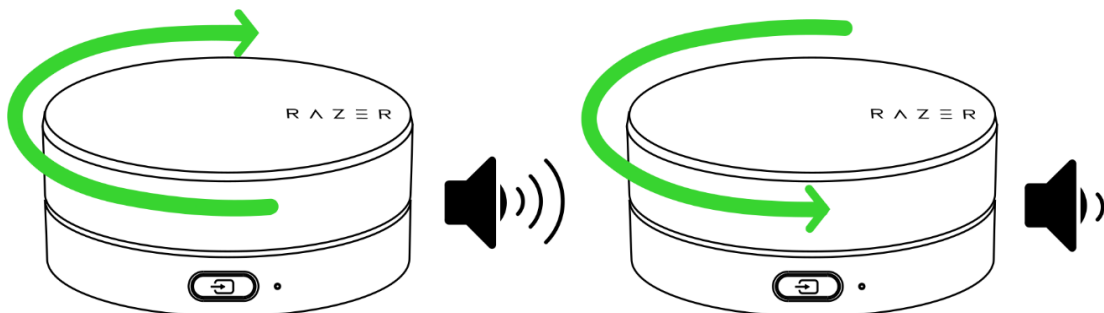

SWITCHING BETWEEN AUDIO SOURCES

While powered on, press the Source button to switch between PC mode and Bluetooth mode.

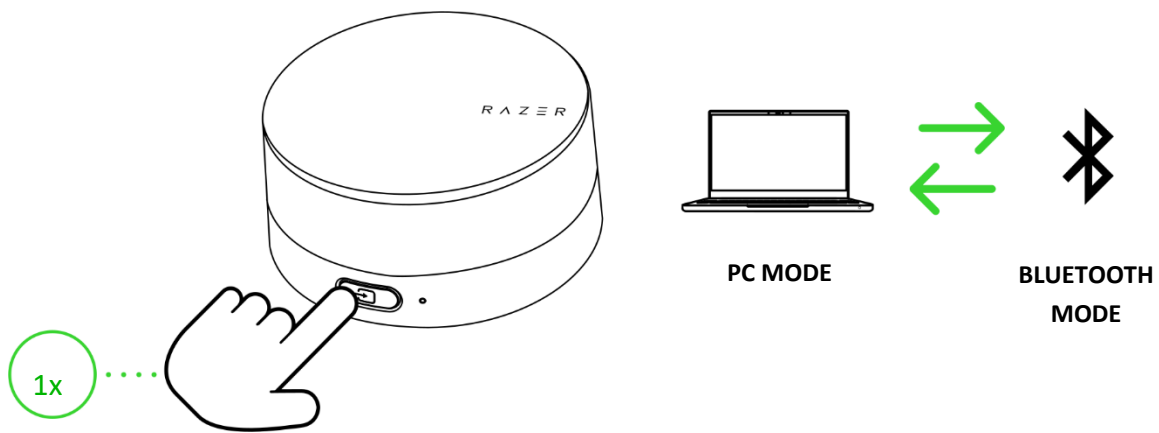

TOGGLING BETWEEN PC AUDIO DEVICES

While powered on and in PC mode, press and hold the Source button to switch between the gaming speakers and a selected secondary PC playback device on Razer Synapse. The status indicator will briefly blink in yellow to indicate that the gaming speakers toggled to a secondary PC playback device and vice versa. [Learn more about PC audio device toggling](#)

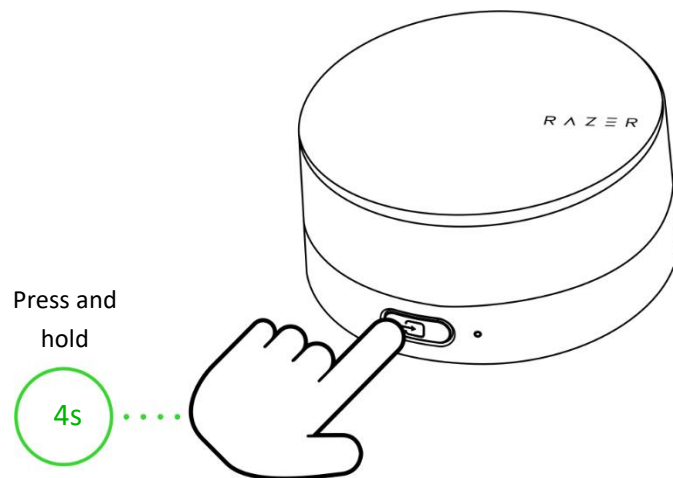

CHANGING EQ PRESETS

Double press the Source button to cycle through the Flat, Game, Music, Movie, and Custom EQ presets.

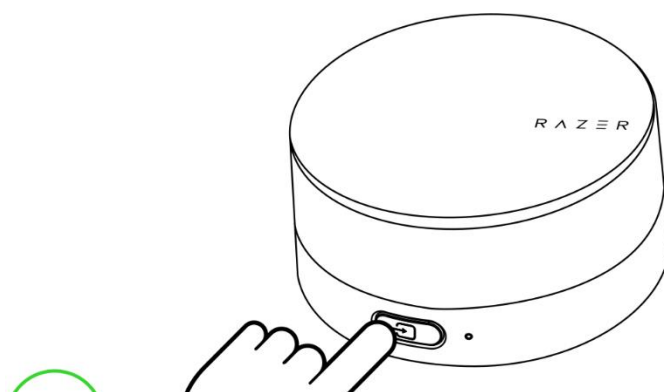

2x

i You can also change the active EQ preset and personalize the Custom EQ preset using the Razer Synapse app (PC). [Learn more about the Audio Equalizer](#)

REACTIVATING BLUETOOTH PAIRING MODE (FOR NEW DEVICES)

1. While in Bluetooth mode, press and hold the Source button for 4 seconds to activate pairing mode. The status indicator on the control pod will blink in blue, and an audio prompt will be heard to indicate that the gaming speakers are in pairing mode.

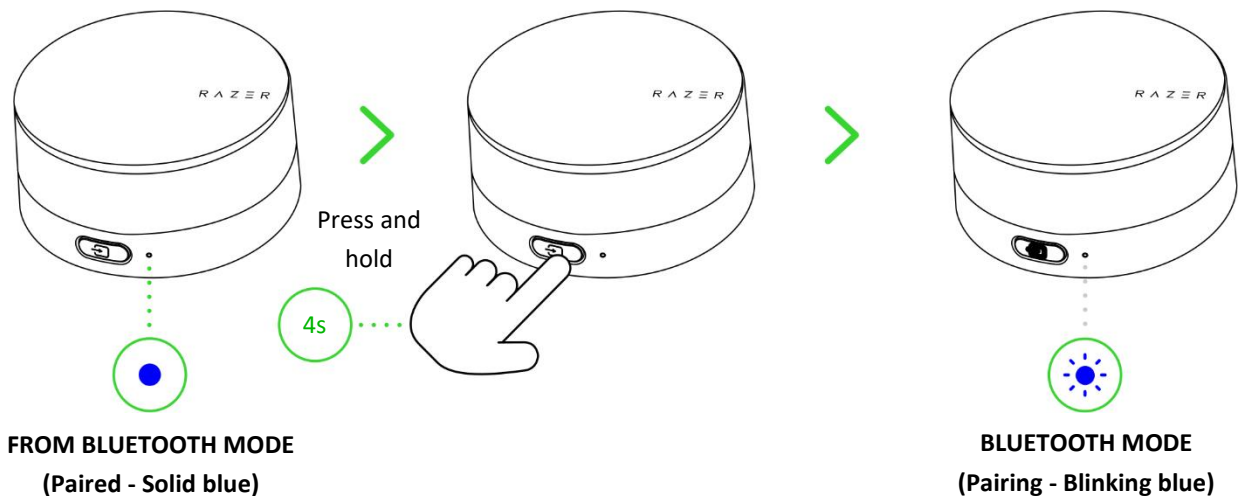

2. Activate Bluetooth on your device and select "**Razer Nommo V2 Pro (BT)**" from the list of devices found.



3. Wait until both devices are connected. The status indicator on the control pod will turn solid blue, and an audio prompt will be heard to indicate that the gaming speakers are now connected to your device.

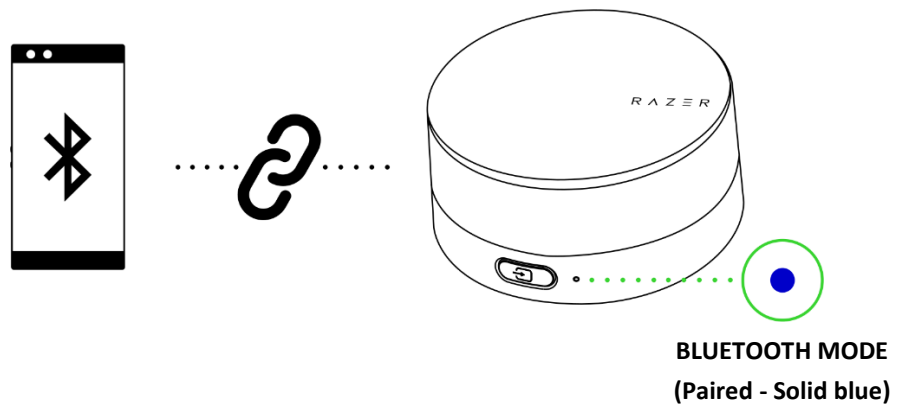

ENABLING / DISABLING THE REAR PROJECTION LIGHTING

While holding the power button / media control knob, rotate it clockwise to enable the rear projection lighting, or counterclockwise to disable it.

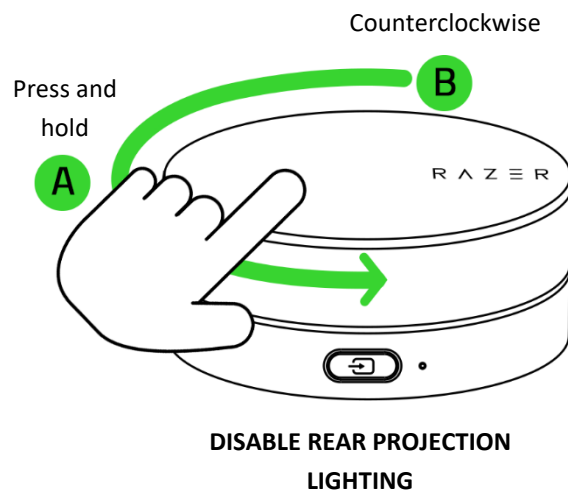
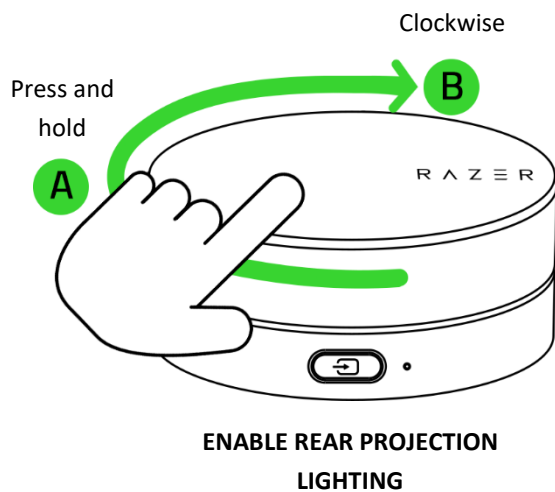

TOGGLING THE AUDIO REACTIVE EFFECT ON/OFF

While in Bluetooth mode, press the power and source buttons simultaneously to toggle the Audio reactive effect on/off and allow the speakers' lighting to react directly to the audio being played.

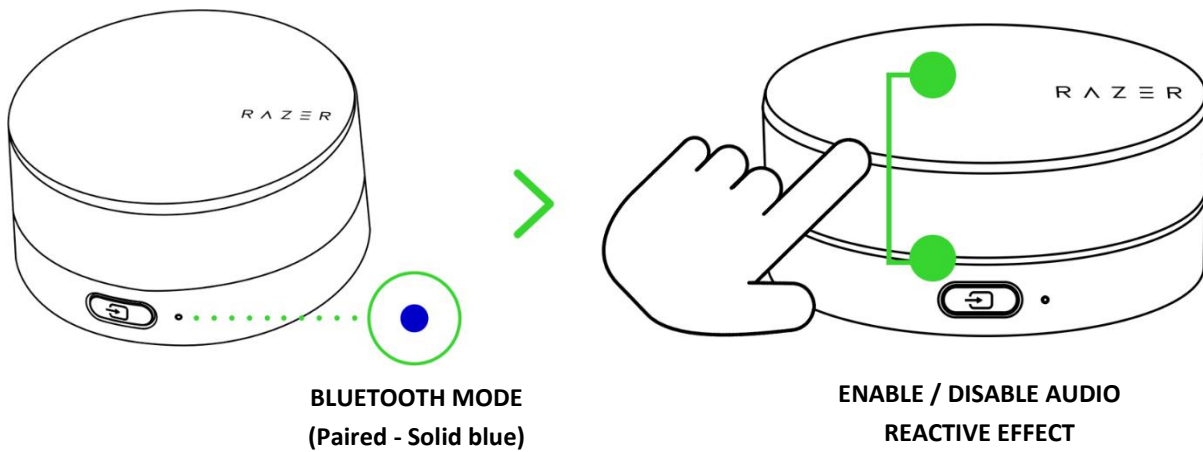

i This function only works in Bluetooth mode.

QUICK FUNCTIONS REFERENCE

Power button / Media control knob

Single press	Mute / unmute audio
Double press	Play / pause a track
Triple press	Skip a track
Press and hold for 3 secs	Power on / off
Rotate clockwise / counterclockwise	Increase or decrease volume
Press and hold + rotate clockwise	Enable rear projection lighting
Press and hold + rotate counterclockwise	Disable rear projection lighting

Source button

Single press	Switch between audio sources
Double press	Cycle through EQ presets

Press and hold for 4 secs PC mode)	(in	Toggle between PC audio devices (Requires Razer Synapse)
Press and hold for 4 secs Bluetooth mode)	(in	Reactivate Bluetooth pairing mode

Power button + Source button

Single press (in Bluetooth mode)	Toggle Audio Reactive effect on / off (Only works in Bluetooth mode)
-------------------------------------	---

RAZER SYNAPSE (PC)

Use the Razer Synapse app to switch between audio sources, customize your speakers' lighting, personalize an EQ preset, and adjust other advanced features for a truly immersive listening experience.

 Only available on Windows® 10 64-bit (or higher). Install Razer Synapse when prompted, or download the installer from razer.com/synapse.

8. CONFIGURING YOUR RAZER NOMMO V2 PRO VIA RAZER SYNAPSE

i *Internet connection is required for installation, updates, and cloud-based features. Registering for a Razer ID account is recommended but optional. All listed features are subject to change based on the current software version, the connected device(s), and supported apps and software.*

SYNAPSE TAB

The Synapse tab is your default tab when you first launch Razer Synapse. This tab allows you to navigate the Dashboard subtab.

Dashboard

The Dashboard subtab is an overview of your Razer Synapse, where you can access all your Razer devices, modules, and online services.

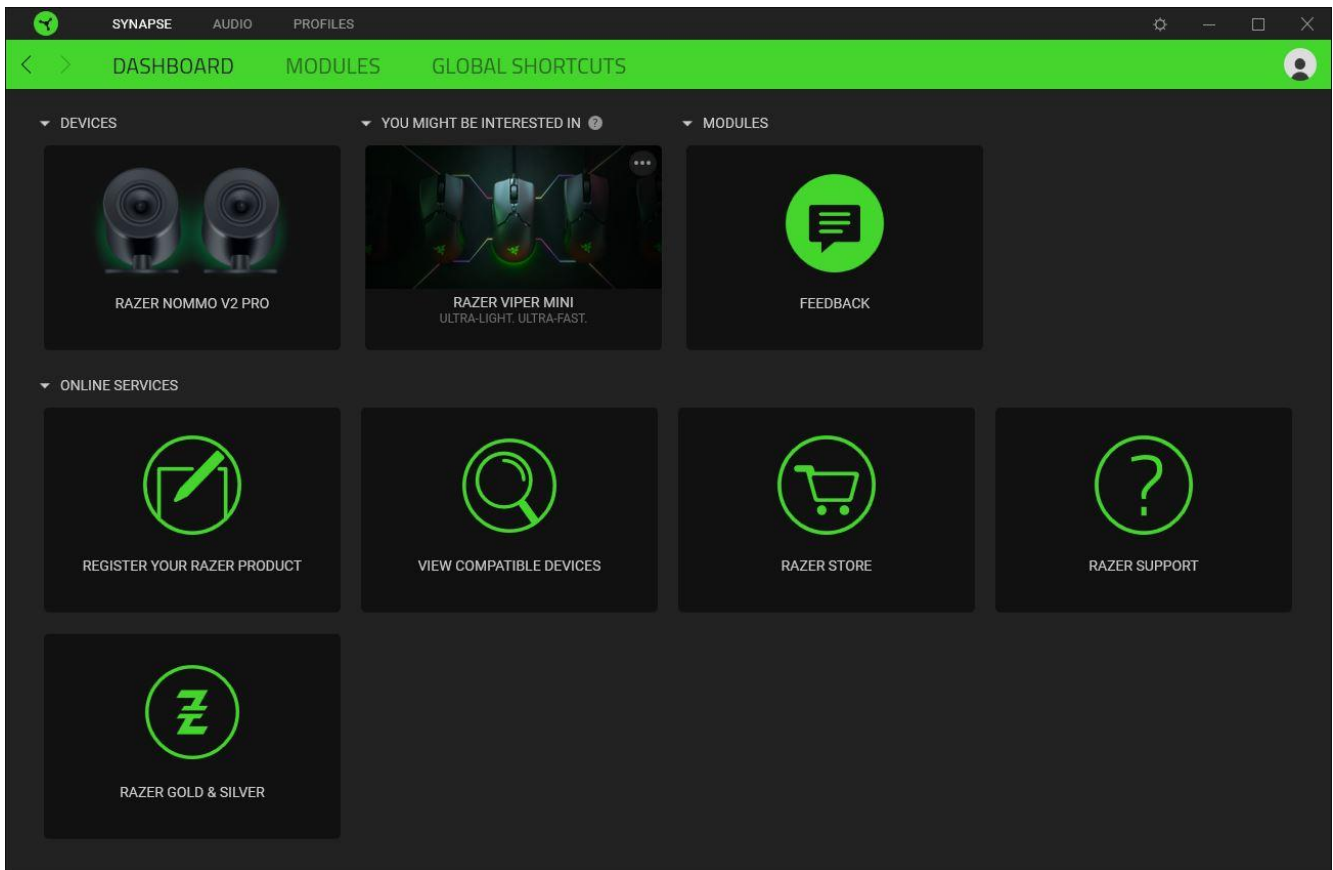

Modules

The Modules subtab displays all installed and available modules for installation.

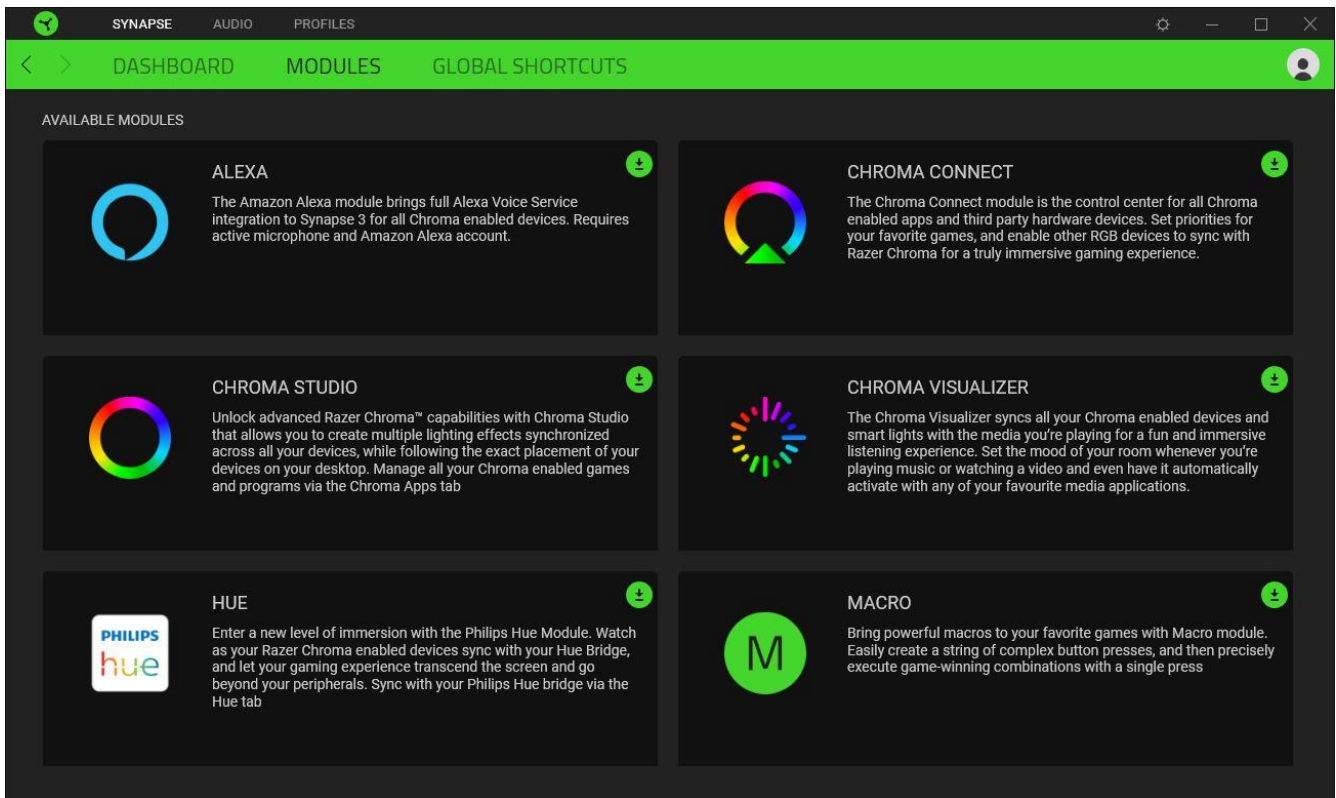

Global Shortcuts

Bind operations or Razer Synapse functions to custom key-combinations from any Razer Synapse-enabled device inputs, which apply across all device profiles. [Learn more about Profiles](#)

! *Only Razer Synapse-enabled device inputs will be recognized.*

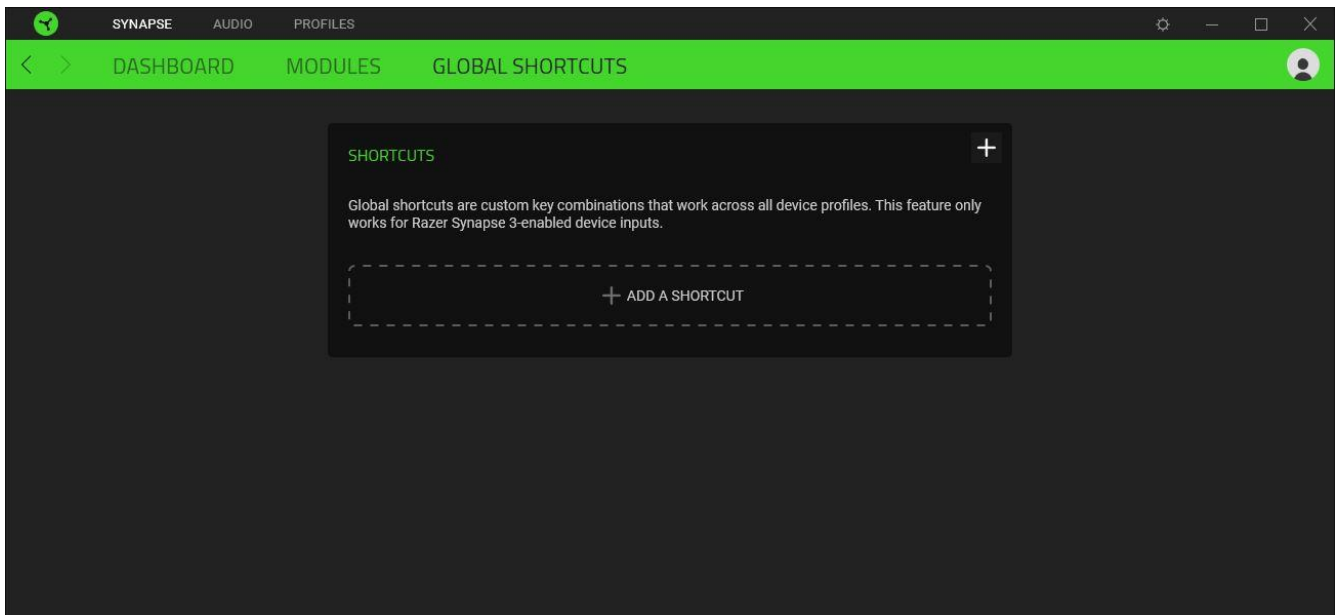

AUDIO TAB

The Audio tab is the main tab for your Razer Nommo V2 Pro, where you can customize your gaming speakers' settings to unleash their full potential. Changes made under this tab are automatically saved to your system and cloud storage.

Sound

The Sound subtab is for switching between Stereo audio and THX Spatial Audio, adjusting the gaming speakers' volume, setting a secondary playback device, switching to Bluetooth audio source, and changing its audio equalizer using presets or your own setting.

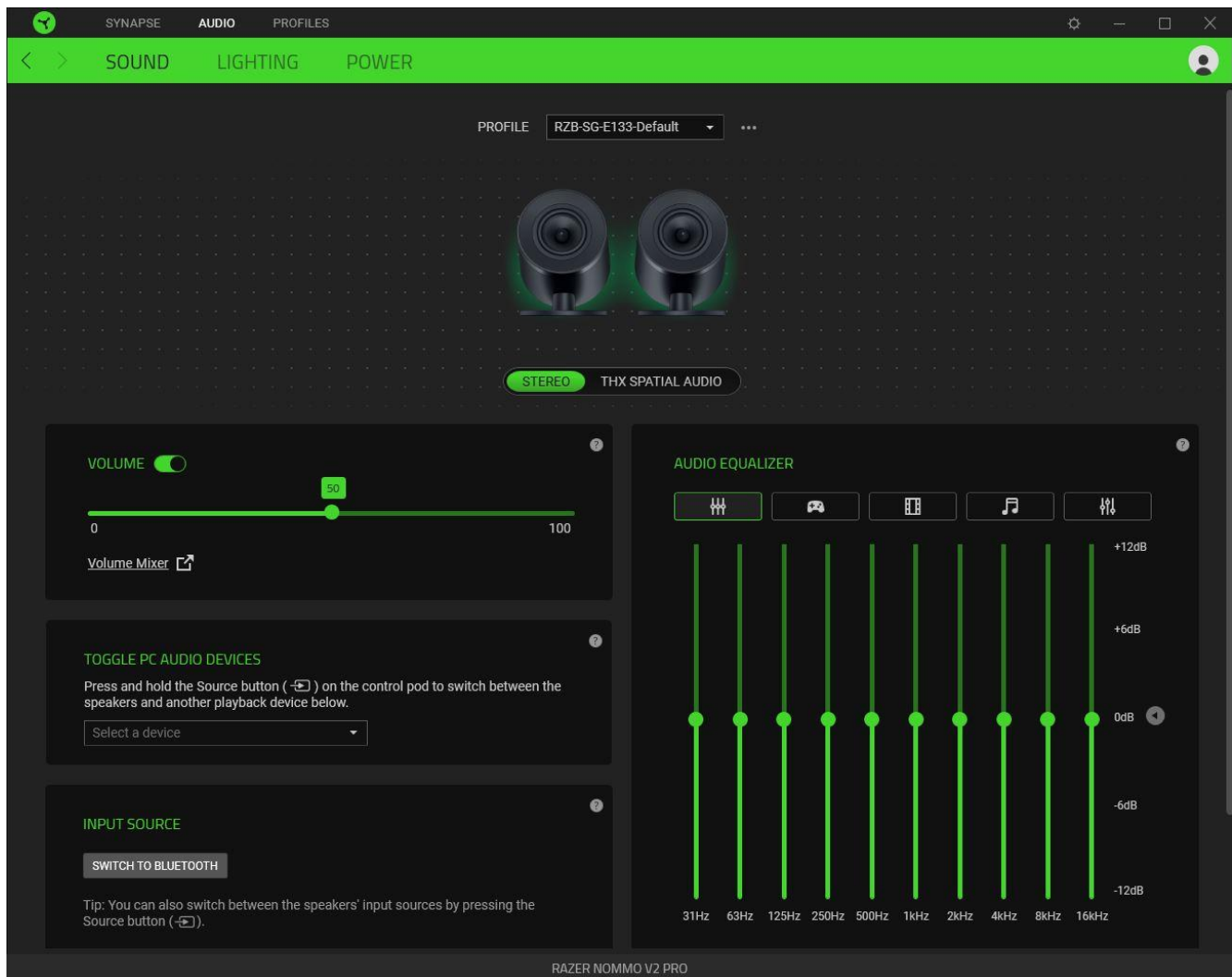

Profile

A Profile is a data storage for keeping all your Razer peripherals' settings. By default, the profile name is based on your system's name. To add, rename, duplicate, or delete a profile, simply press the Miscellaneous button (●●●).

Stereo / THX Spatial Audio

Toggle between Stereo audio and THX Spatial Audio.

Volume

Adjust the audio volume of the gaming speakers. You may also access the Windows volume mixer of the current playback device, where you can proportionally adjust the overall volume of the system or individually adjust the volume of each active application.

Toggle PC audio devices

Set a secondary PC playback device that you can immediately switch to when you press and hold the Source button.

Input source

Allows you to switch the gaming speakers to Bluetooth mode using Razer Synapse.

 *Razer Synapse won't be able to revert to PC mode when the gaming speakers have been set to Bluetooth mode. To set the gaming speakers to PC mode, press the Source button.*

Audio equalizer

Select any available equalizer preset created for the best audio experience designed for balance, gaming immersion, movie viewing, or enjoying your favorite music. Manually adjusting any equalizer preset will automatically set it to Custom.

Sound Properties

Launches the Windows Sound Properties window where you can manage your system's sound settings, such as modifying the playback and recording device settings, sound scheme, and default communications activity.

Lighting

The Lighting subtab enables you to customize the lighting on the gaming speakers.

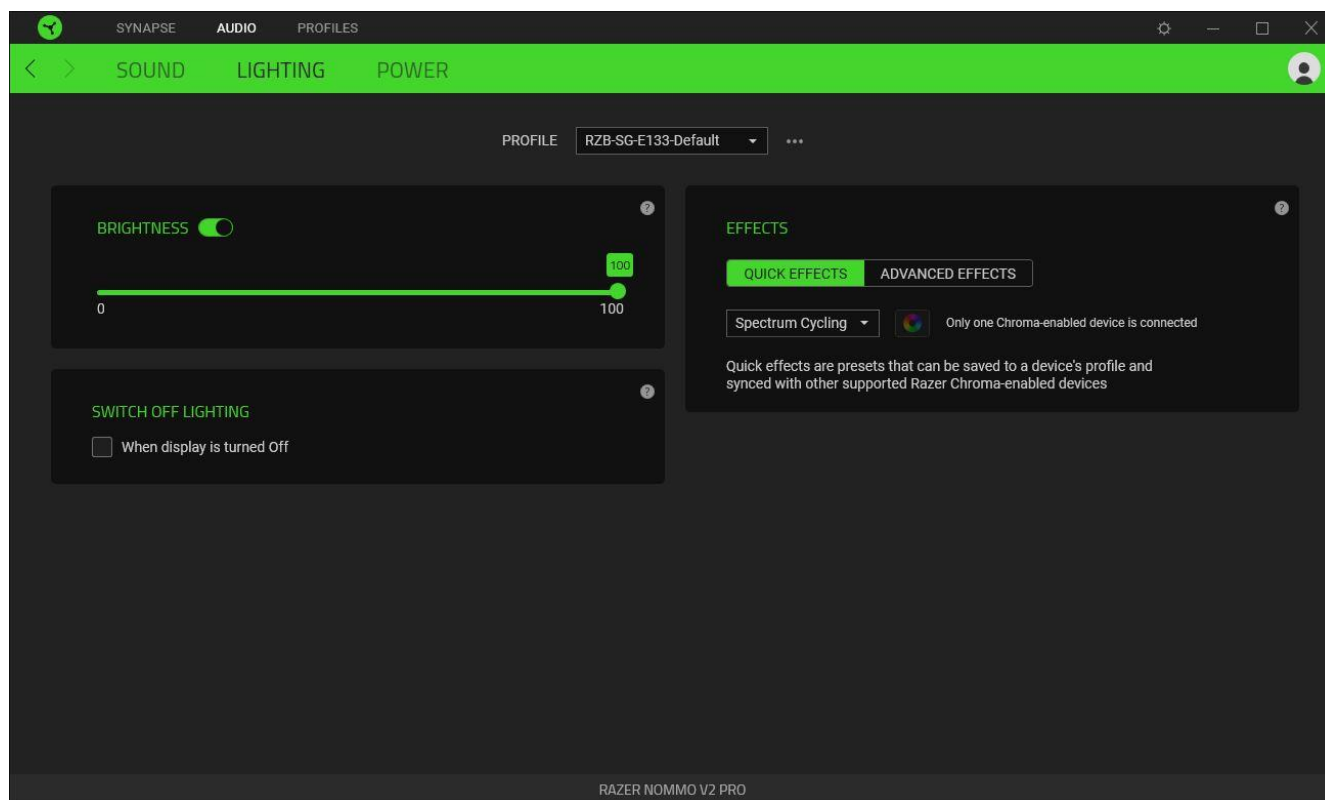

Brightness



You can turn off the gaming speakers' lighting by toggling the Brightness option or increase/decrease their luminance using the slider.



Switch Off Lighting

This power-saving tool allows you to disable the gaming speakers' lighting when your system's display is turned off.

Quick Effects

Several quick effects can be selected and applied to your gaming speakers' lighting, as listed here:

	Name	Description	How to set up
	Audio meter	The gaming speakers will light up according to the audio level with a default spectrum of colors	Select a Color Boost level
	Breathing	The rear projection lighting will fade in and out of the selected color(s)	Select up to 2 colors or randomize colors

	Spectrum cycling	The rear projection lighting will cycle between 16.8 million colors indefinitely	No further customization required
	Static	The gaming speakers will remain lit in the selected color	Select a color

If you have other supported Razer Chroma-enabled devices, you can synchronize their quick effects with your Razer device by clicking the Chroma Sync button ().

 *Only devices that support the selected lighting effect will synchronize.*

Advanced Effects

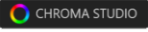
The Advanced Effects option allows you to choose a Chroma Effect you want to use on your Razer Chroma-enabled peripheral. To start making your own Chroma Effect, simply press the Chroma Studio button ().

Power

Use the Power subtab to enable the gaming speakers to enter standby mode when left idle for a certain period.

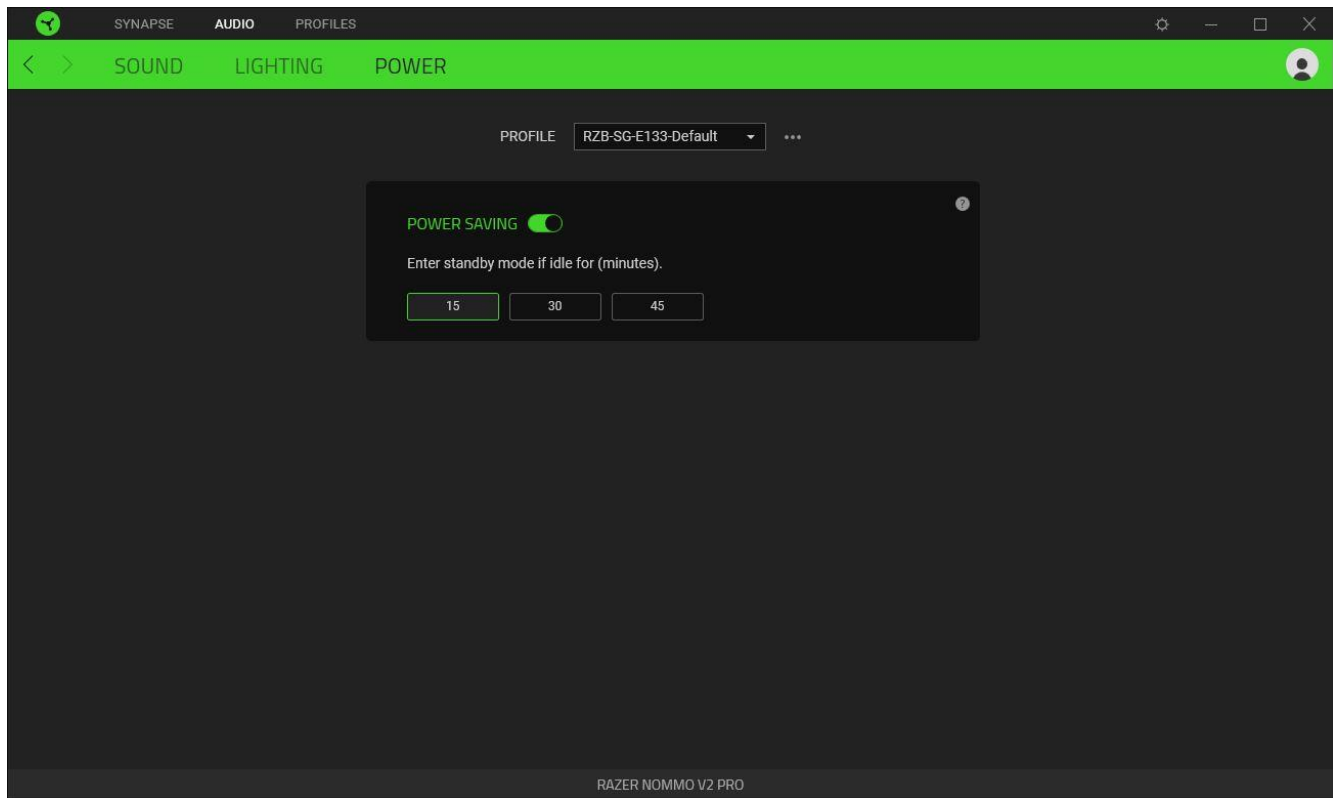





PROFILES TAB

The Profiles tab is a convenient way to manage all your profiles and link them to your games and applications.

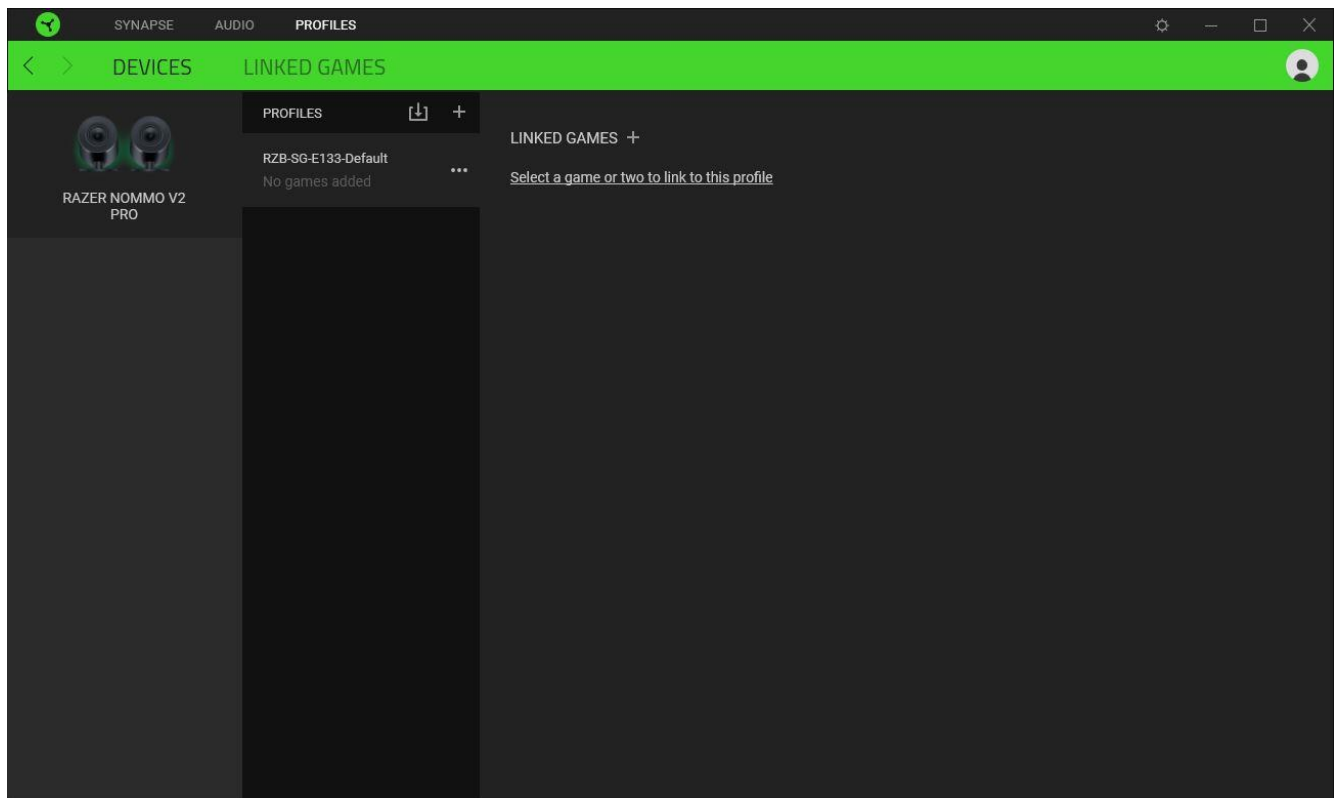
Devices

View which games are linked to each device's profiles or which Chroma Effect is linked to specific games using the Devices subtab.



You can import Profiles from your computer or the cloud through the import button () or create new profiles within the selected device using the add button (). To rename, duplicate, export, or delete a profile, simply press the Miscellaneous button (). Each profile can be set to activate when you run an application using the Linked Games option.

Linked Games

The Linked Games subtab allows you to add games, view devices linked to games, or search for added games. You can also sort games based on alphabetical order, last played, or most played. Added games will still be listed here, even if they are not linked to a Razer device.

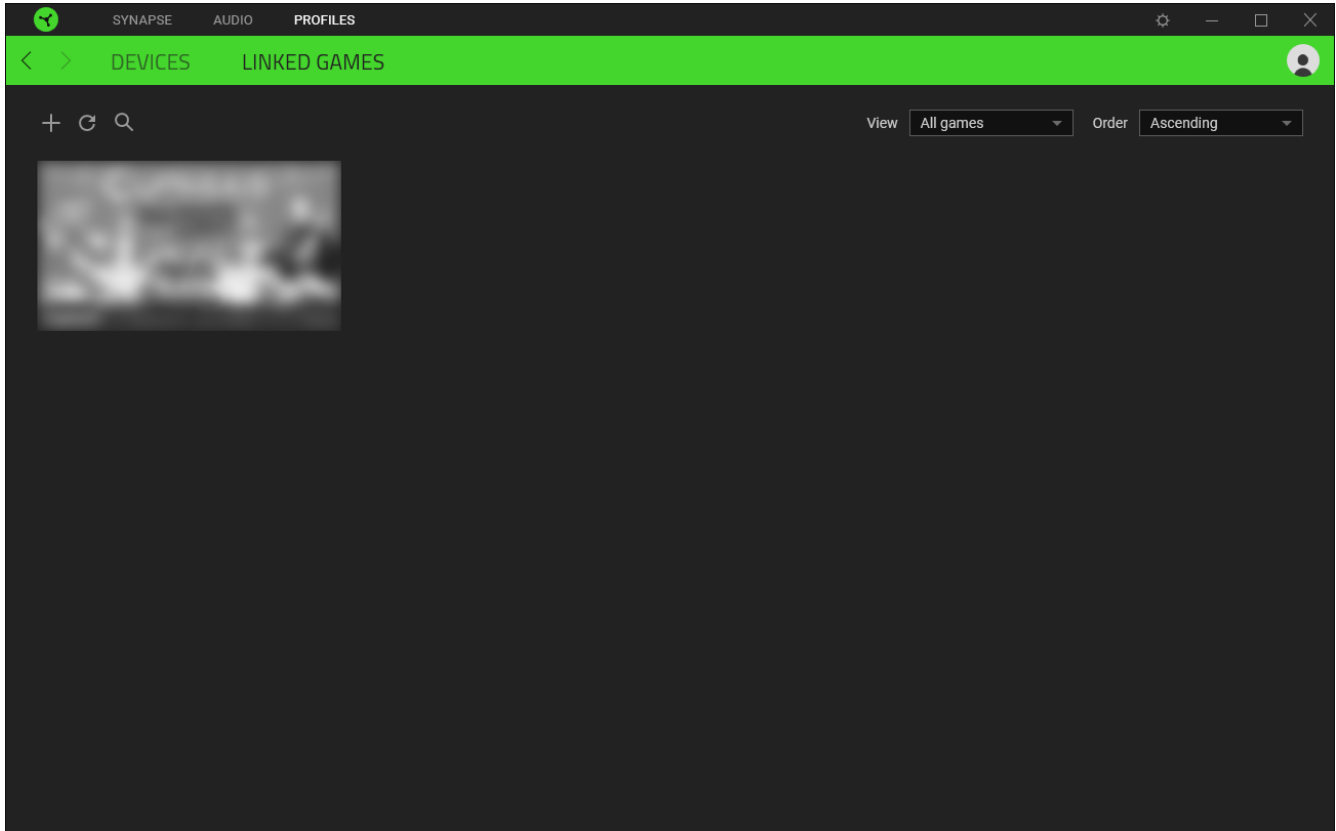

To link games to connected Razer devices or Chroma Effects, simply click on any game from the list, and then click **Select a device and its profile to launch automatically during gameplay** to select the Razer device or Chroma Effect it will link with. Once connected, you may click the Miscellaneous button (●●●) of the corresponding Chroma Effect or device to select a specific Chroma Effect or profile.

SETTINGS WINDOW

The Settings window, accessible by clicking the (⚙) button on Razer Synapse, enables you to configure the startup behavior and display language of Razer Synapse, view the master guides of each connected Razer device, or perform a factory reset on any connected Razer device.

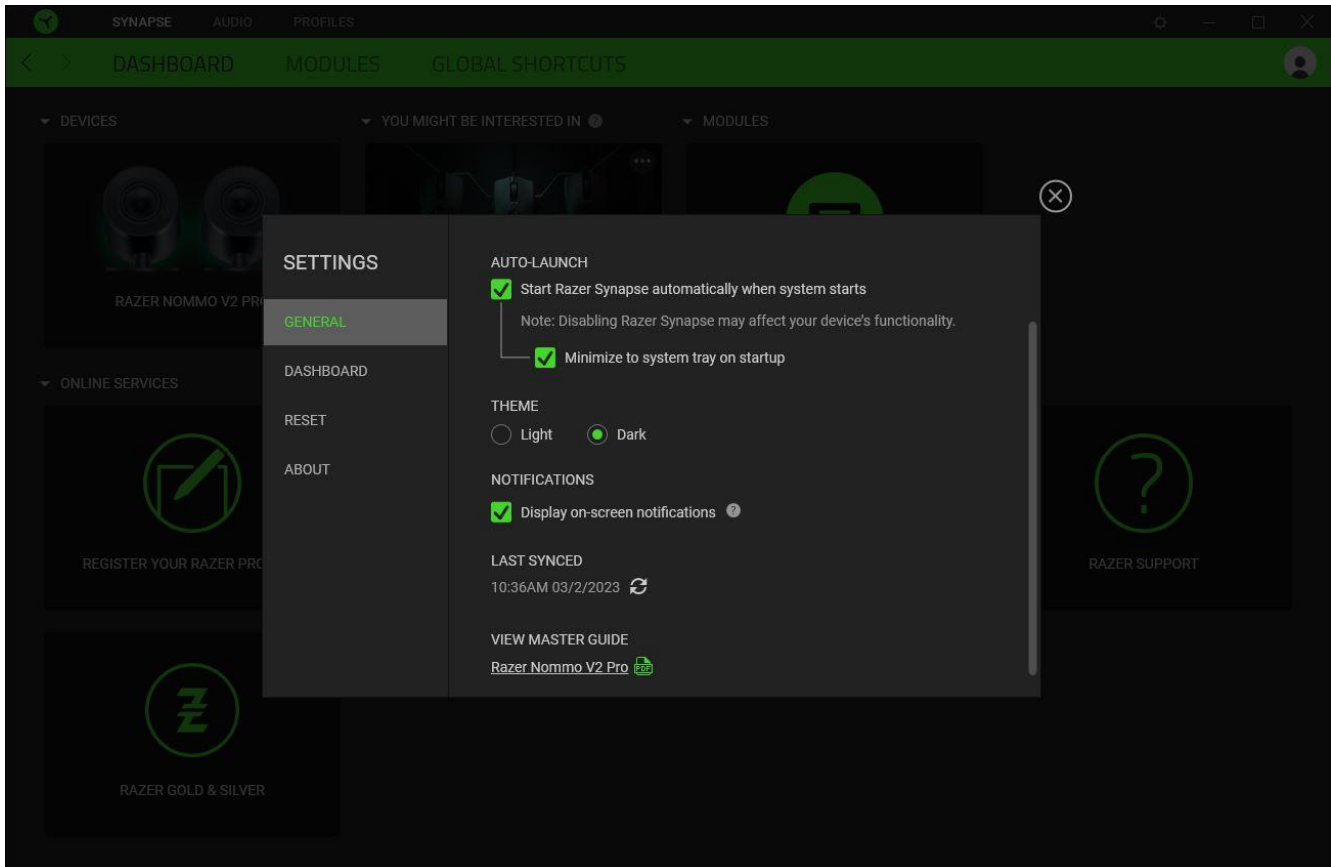

General tab

The General tab lets you change the software's display language, startup behavior, theme, and on-screen notifications display. You may also manually sync your profiles to the cloud (↻) or view the master guide of all connected Razer devices and installed modules.

Dashboard tab

Use the Dashboard tab to customize which Razer device recommendations based on your setup, and the games you play will appear on the Dashboard.

Reset tab

The Reset tab allows you to perform a factory reset on all connected Razer devices with on-board memory and/or reset Razer Synapse tutorials to acquaint yourself again with Razer Synapse's new features on its next launch.



All profiles stored on the selected device's on-board memory will be erased when you reset a Razer device.

About tab

The About tab displays brief software information and copyright statement, and provides relevant links for its terms of use. You may also use this tab to check for software updates, or as quick access to Razer's social communities.

9. SAFETY AND MAINTENANCE

WARNING

- Use the appropriate power cord for your region when plugging a power cord into the subwoofer.
 - If you detect any hazard risk on the gaming speakers and/or the subwoofer, immediately unplug both devices from the power outlet.
-

SAFETY GUIDELINES

To achieve maximum safety while using your Razer Nommo V2 Pro, we suggest that you adopt the following guidelines:

Should you have trouble operating the device properly and troubleshooting does not work, unplug the device and contact the Razer hotline or go to support.razer.com for assistance.

Don't take apart the device, and don't attempt to operate it under abnormal current loads. Doing so will void your warranty.

Before connecting the left speaker connector, align its pins correctly to the left speaker port. Don't forcefully plug the left speaker connector into the left speaker port.

Keep the device away from liquid, humidity, or moisture. Operate the device only within the specific temperature range of 0°C (32°F) to 40°C (104°F). Should the temperature exceed this range, unplug and/or switch off the device to stabilize the temperature to an optimal level.

MAINTENANCE AND USE

The Razer Nommo V2 Pro requires minimum maintenance to keep it in optimum condition. Once a month, we recommend you clean each speaker and the subwoofer using a soft cloth or cotton swab to prevent dirt buildup. Don't use soap or harsh cleaning agents.

10. LEGALESE

COPYRIGHT AND INTELLECTUAL PROPERTY INFORMATION

©2023 Razer Inc. All rights reserved. Razer, the triple-headed snake logo, Razer logo, "For Gamers. By Gamers.", and "Razer Chroma" logo are trademarks or registered trademarks of Razer Inc. or affiliated companies in the United States and other countries. All other trademarks are the property of their respective owners.

The Bluetooth® word mark and logos are registered trademarks owned by Bluetooth SIG, Inc., and any use of such marks by Razer is under license.

THX and the THX Logo are the property of THX Ltd., registered in the U.S. and other countries.

Windows and the Windows logo are trademarks of the Microsoft group of companies.

Razer Inc. ("Razer") may have copyright, trademarks, trade secrets, patents, patent applications, or other intellectual property rights (whether registered or unregistered) concerning the product in this guide. Furnishing of this guide does not give you a license to any such copyright, trademark, patent or other intellectual property right. The Razer Nommo V2 Pro (the "Product") may differ from pictures whether on packaging or otherwise. Razer assumes no responsibility for such differences or for any errors that may appear. Information contained herein is subject to change without notice.

LIMITED PRODUCT WARRANTY

For the latest and current terms of the Limited Product Warranty, please visit [razer.com/warranty](https://www.razer.com/warranty).

LIMITATION OF LIABILITY

Razer shall in no event be liable for any lost profits, loss of information or data, special, incidental, indirect, punitive or consequential or incidental damages, arising in any way out of distribution of, sale of, resale of, use of, or inability to use the Product. In no event shall Razer's liability exceed the retail purchase price of the Product.

GENERAL

These terms shall be governed by and construed under the laws of the jurisdiction in which the Product was purchased. If any term herein is held to be invalid or unenforceable, then such term (in so far as it is invalid or unenforceable) shall be given no effect and deemed to be excluded without invalidating any of the remaining terms. Razer reserves the right to amend any term at any time without notice.