



# RAZER LEVIATHAN V2 PRO

MASTER GUIDE

Experience the next innovation in 3D spatial audio with the **Razer Leviathan V2 Pro**—the world's first PC soundbar with AI head tracking and adaptive beamforming. Directing sound to your ears through intelligent on-the-fly tracking, enjoy ultra-personalized audio with untold accuracy and immersion.

# CONTENTS

1. WHAT'S INSIDE .....	3
2. WHAT'S NEEDED .....	5
3. LET'S GET YOU COVERED.....	5
4. TECHNICAL SPECIFICATIONS .....	6
5. SETTING UP YOUR RAZER LEVIATHAN V2 PRO .....	7
6. CONNECTING TO YOUR SOUNDBAR .....	9
7. USING YOUR SOUNDBAR .....	14
8. CONFIGURING YOUR RAZER LEVIATHAN V2 PRO VIA RAZER SYNAPSE.....	21
9. SAFETY AND MAINTENANCE .....	33
10. LEGALESE.....	34

# 1. WHAT'S INSIDE

- Razer Leviathan V2 Pro

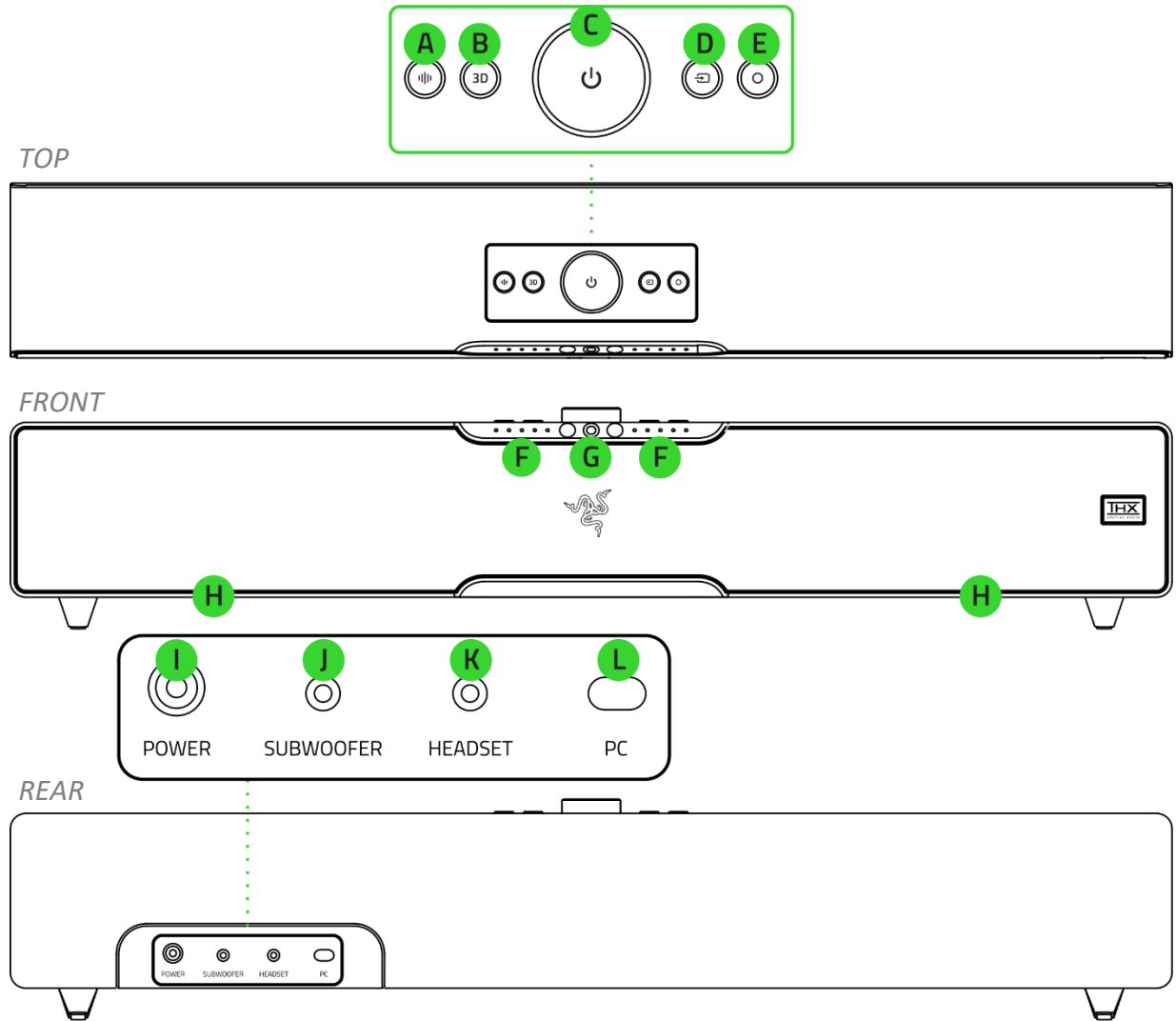

- A. Equalizer button
- B. Audio mode button
- C. Power button / Volume control knob
- D. Source button
- E. Chroma button
- F. Indicator LEDs
- G. Integrated IR camera\*
- H. Soundbar lighting Powered by Razer Chroma™ RGB
- I. Power port
- J. Subwoofer port
- K. Headset port
- L. USB Type C port

*\*The soundbar only utilizes the IR camera to detect and track the position of your ears; it's not capable of capturing images or recording videos.*

- Subwoofer

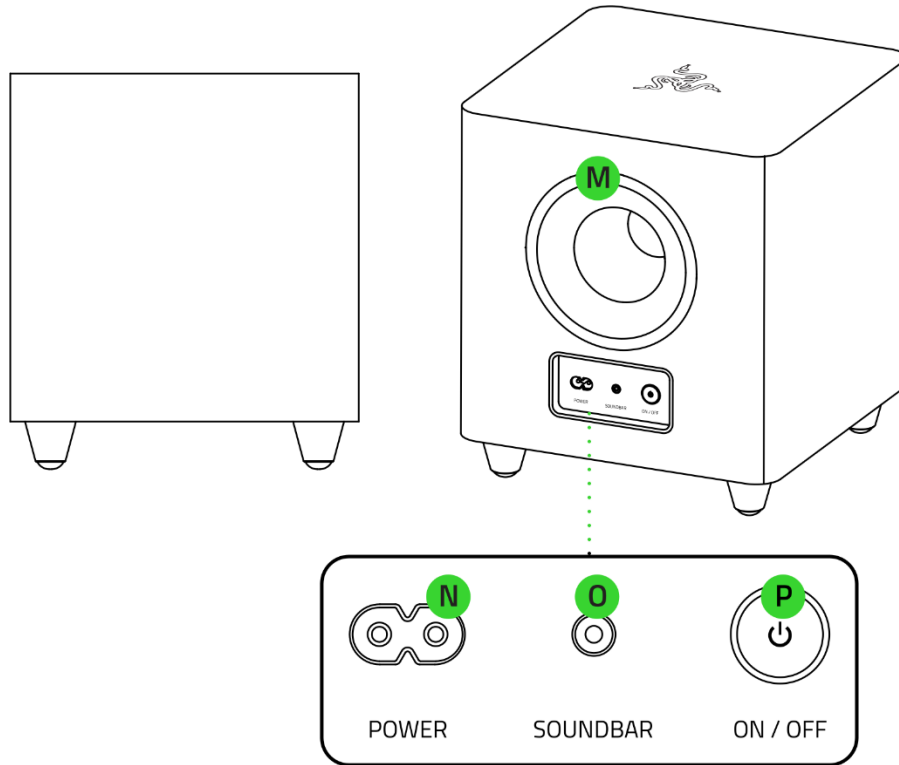

- M. Rear-facing bass port
- N. Power port
- O. Soundbar port
- P. Power button

- USB Type A to USB Type C cable

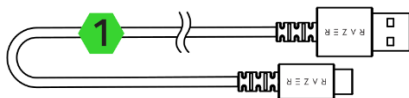

- Soundbar power adapter + regional power cords\*\*

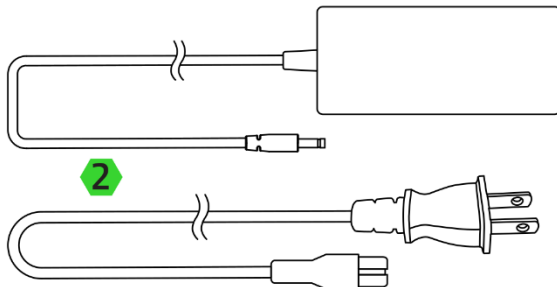

- Subwoofer regional power cords\*\*

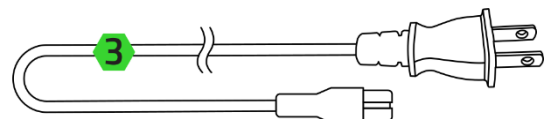

- 2.5 mm Aux cable (for soundbar to subwoofer connection)

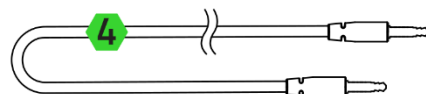

- Important product information guide

\*\*May vary for specific regions.

---

## 2. WHAT'S NEEDED

### PRODUCT REQUIREMENTS

- USB Type A port or devices with Bluetooth connectivity

### RAZER AUDIO APP REQUIREMENTS

- iOS 14 / Android 10 (or higher) devices with Bluetooth connectivity
- Internet connection for software installation

### RAZER SYNAPSE REQUIREMENTS

- Windows® 10 64-bit (or higher)
- Internet connection for software installation

---

## 3. LET'S GET YOU COVERED



Register your product and score exclusive benefits

[razerid.razer.com/warranty](https://razerid.razer.com/warranty)

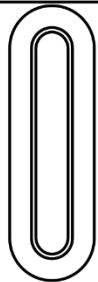

*Your product's  
serial number can  
be found here.*



---

## 4. TECHNICAL SPECIFICATIONS

### TECHNICAL SPECIFICATIONS

- Razer Chroma™ RGB (30 zones)
- THX Spatial Audio
- Bluetooth 5.0
- USB audio input
- 3.5mm socket with mic in
- Wired subwoofer
- Razer Audio app
- Custom 10-band EQ
- Frequency Response: 40Hz – 20 kHz
- Max SPL: 98dB at 1 meter
- Driver specifications:
- Full Range Drivers: 5 x 2.0"
- Down-Firing Subwoofer: 1 x 5.25"
- Driver Type: Full range drivers and subwoofer driver

### COMPATIBILITY

- Bluetooth connection
- USB connection to PC

### CAMERA

- Field of View: 90°
- Optimal distance: 0.3m – 1.5m

---

## 5. SETTING UP YOUR RAZER LEVIATHAN V2 PRO

1. Connect the subwoofer to the subwoofer output port on the soundbar using the 2.5 mm aux cable.

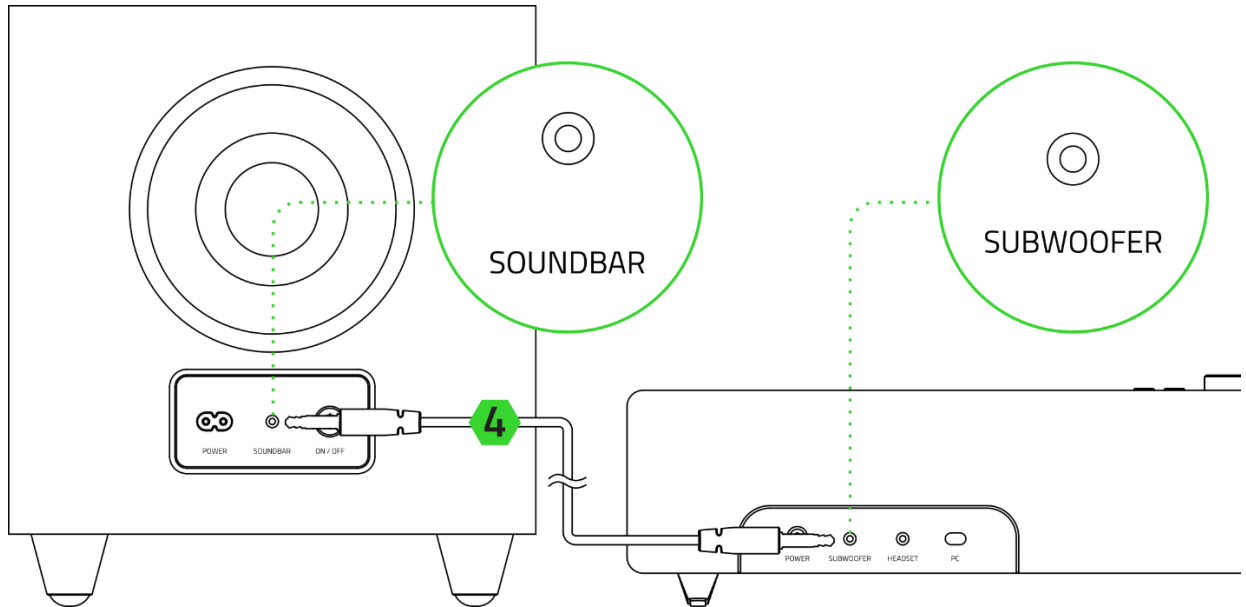

2. Connect the soundbar to any USB Type A ports on your PC using the included USB Type C to USB Type A cable.

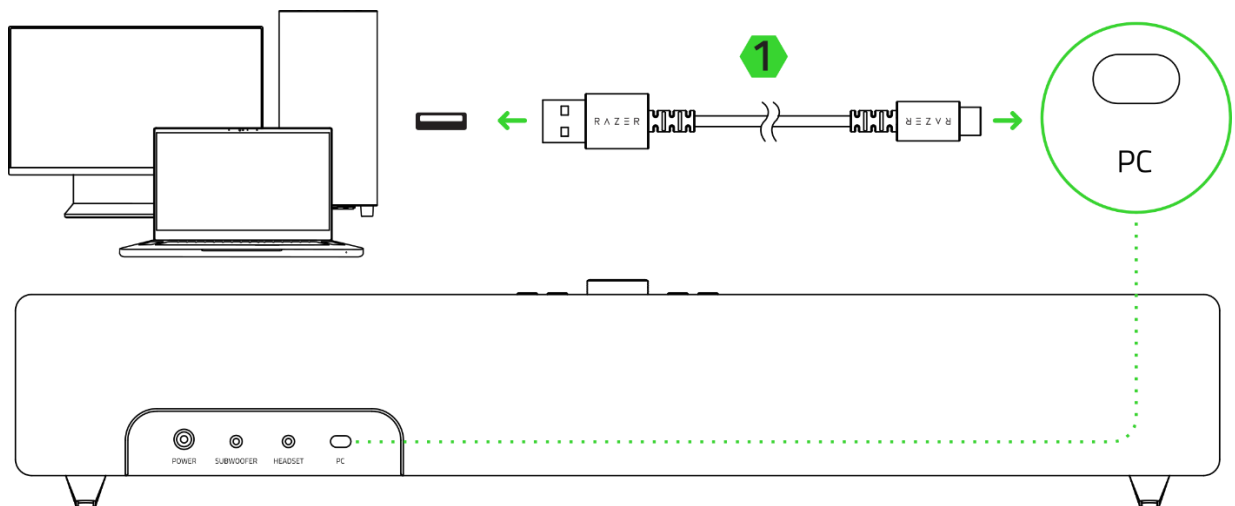

3. With the appropriate power cord connected to the power adapter, connect it to the power port of the Razer Leviathan V2 Pro and plug it into a power outlet.

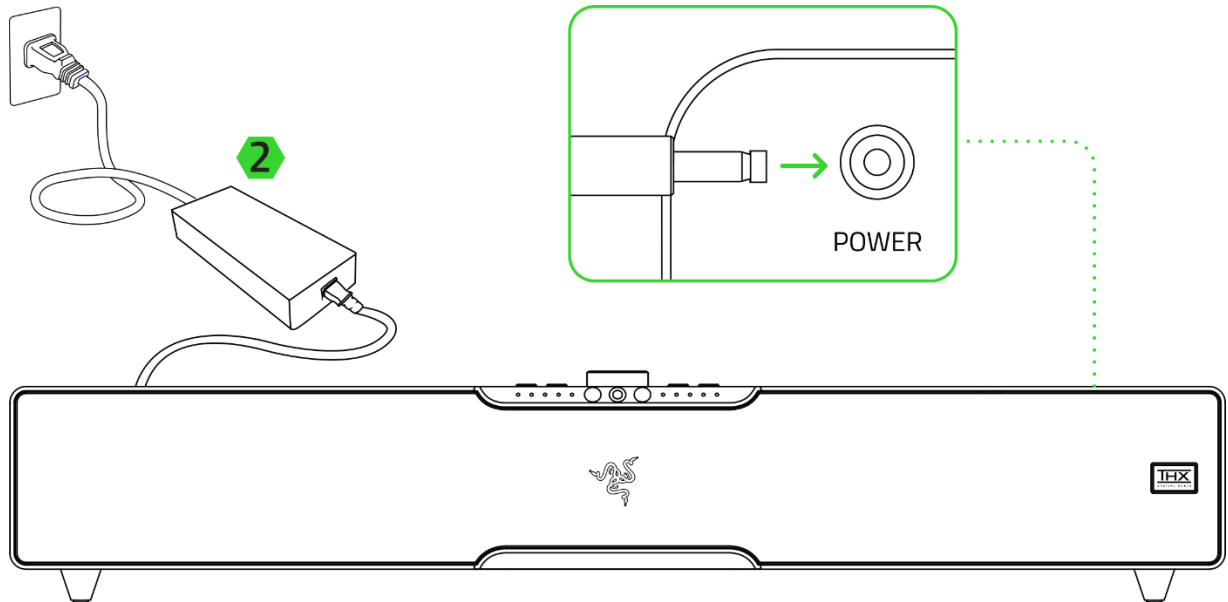

**i** Use the appropriate power cord for your region.

4. Connect the appropriate power cord to the subwoofer and plug it into a power outlet. The subwoofer's Power button will light up, indicating that the subwoofer is powered on.

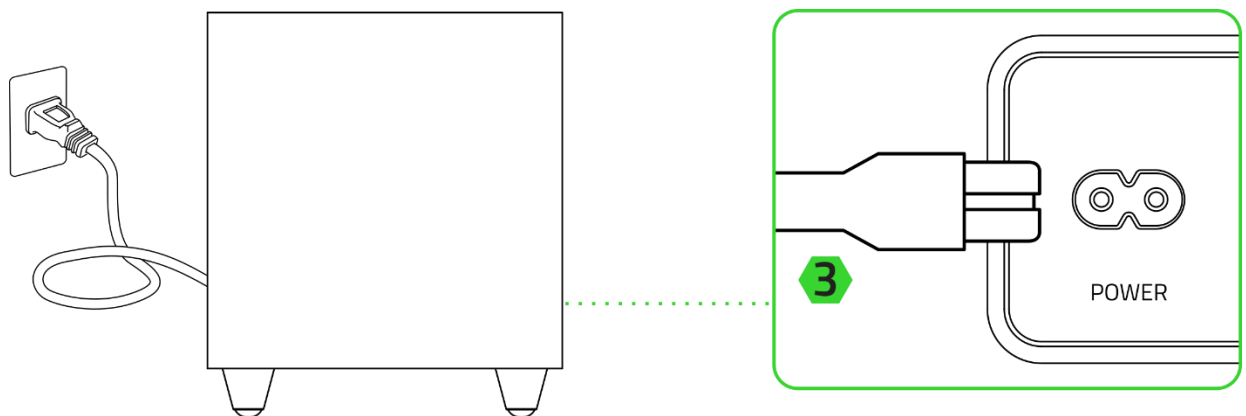

**i** Use the appropriate power cord for your region.

---

## 6. CONNECTING TO YOUR SOUNDBAR

### A. VIA PC MODE

1. Press the Power button to power on the soundbar. All the soundbar's buttons will light up, and the Source button will turn solid green to indicate that the soundbar is in PC mode.

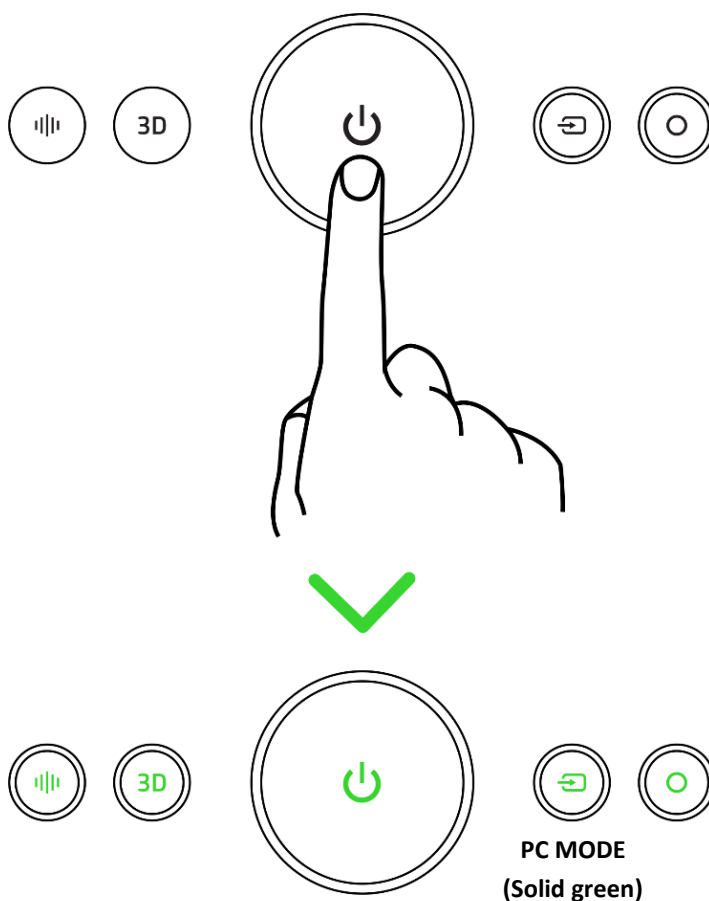

2. Set the **Razer Leviathan V2 Pro** as the default **Output** device on your PC.

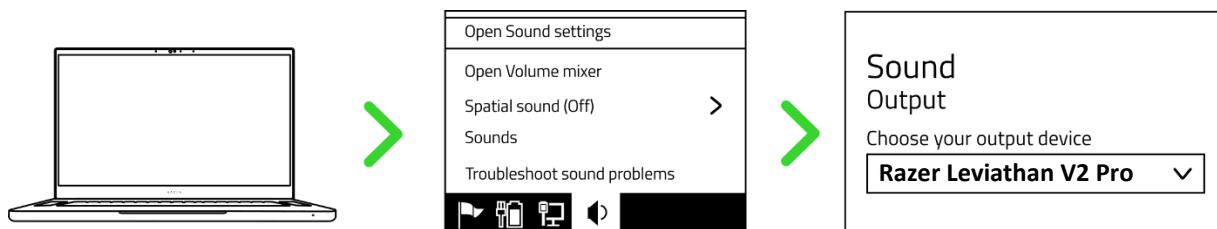

**i** When using the soundbar with compatible devices, set the Razer Leviathan V2 Pro as its default output device (if applicable).

The Razer Leviathan V2 Pro is now ready for use in PC mode.

## B. VIA BLUETOOTH MODE

1. While powered on and in PC mode, press the Source button to switch to Bluetooth mode and activate pairing mode. The Source button will blink in blue, and the indicator LEDs will scroll back and forth to indicate that the soundbar is in pairing mode.

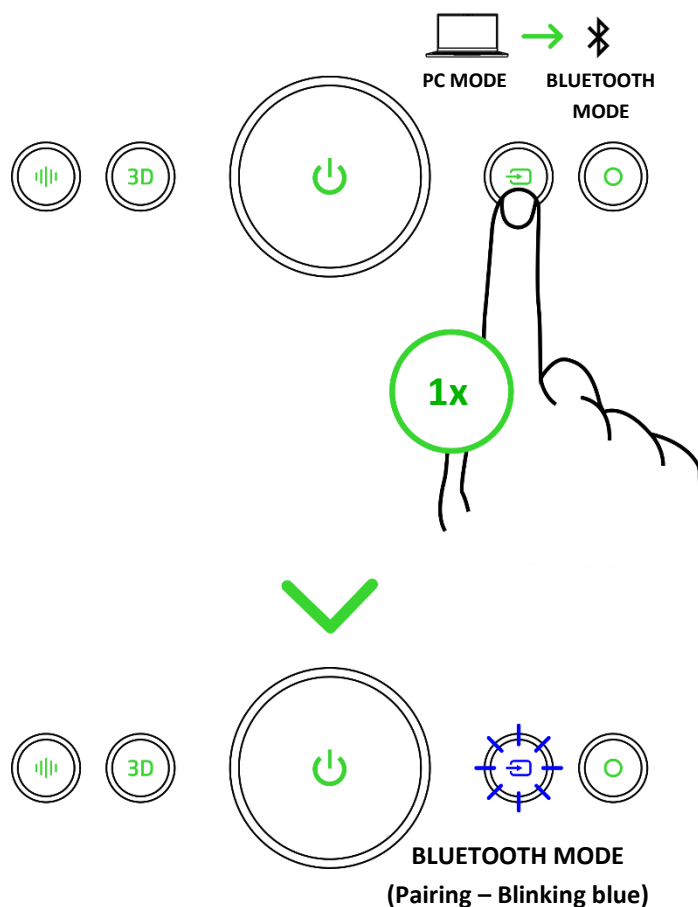

2. Activate Bluetooth on your device and select "Razer Leviathan V2 Pro (BT)" from the available devices.

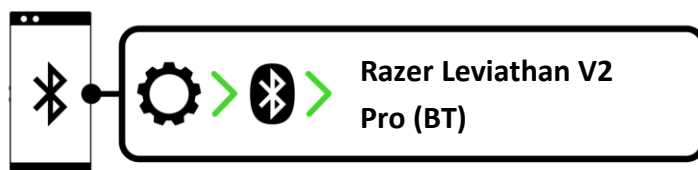

3. Wait until both devices are connected. The Source button will turn solid blue, and the indicator LEDs will turn off to indicate that the soundbar is now connected to your device.

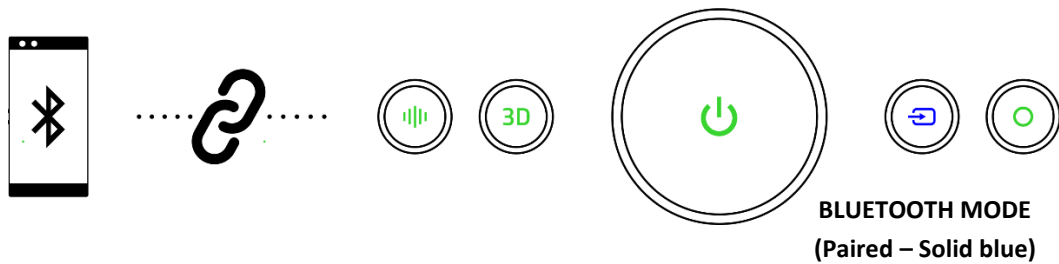

**!** *Instructions are for first-time pairing only. Remember to keep the soundbar within 1 meter of your mobile device when connecting to the soundbar. Once paired, the soundbar will automatically reconnect to your mobile device whenever you switch to Bluetooth mode.*

[Learn more about switching between soundbar modes](#)

The Razer Leviathan V2 Pro is now ready for use in Bluetooth mode.

### C. VIA HEADSET PORT (HEADSET OUTPUT)

**!** *This feature is available in both PC and Bluetooth modes.*

1. Connect your headset (not included) to the headset port of the soundbar.

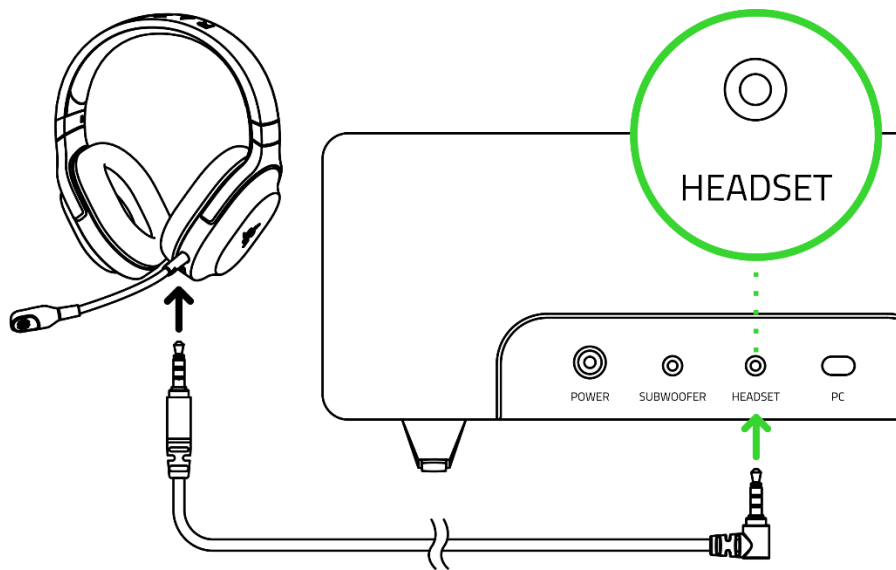

! Razer headset sold separately.

2. While powered on, double press the Source button to toggle between soundbar and headset output. The Source button will blink in green (if the soundbar is in PC mode) or show solid cyan (if the soundbar is in Bluetooth mode) to indicate that the soundbar is using the connected headset as audio output.

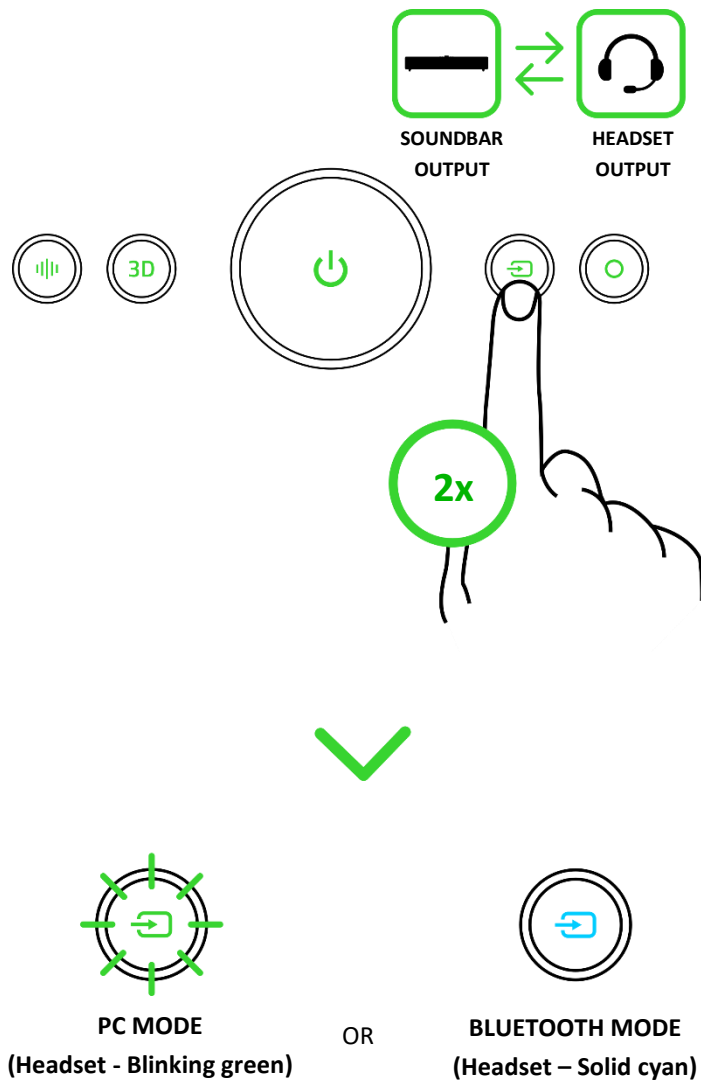

**!** *When the soundbar is toggled to headset output, it will continue using the connected headset as the audio output even as you switch between PC and Bluetooth modes. To use the connected headset as an audio input device, ensure the Razer Leviathan V2 Pro is set as your system's input device.*

---

## 7. USING YOUR SOUNDBAR

### CHANGING EQ PRESETS

Press the Equalizer button to cycle through the Flat, Game, Movie, Music, and Custom EQ presets. The indicator LEDs will briefly display which EQ preset is currently active.

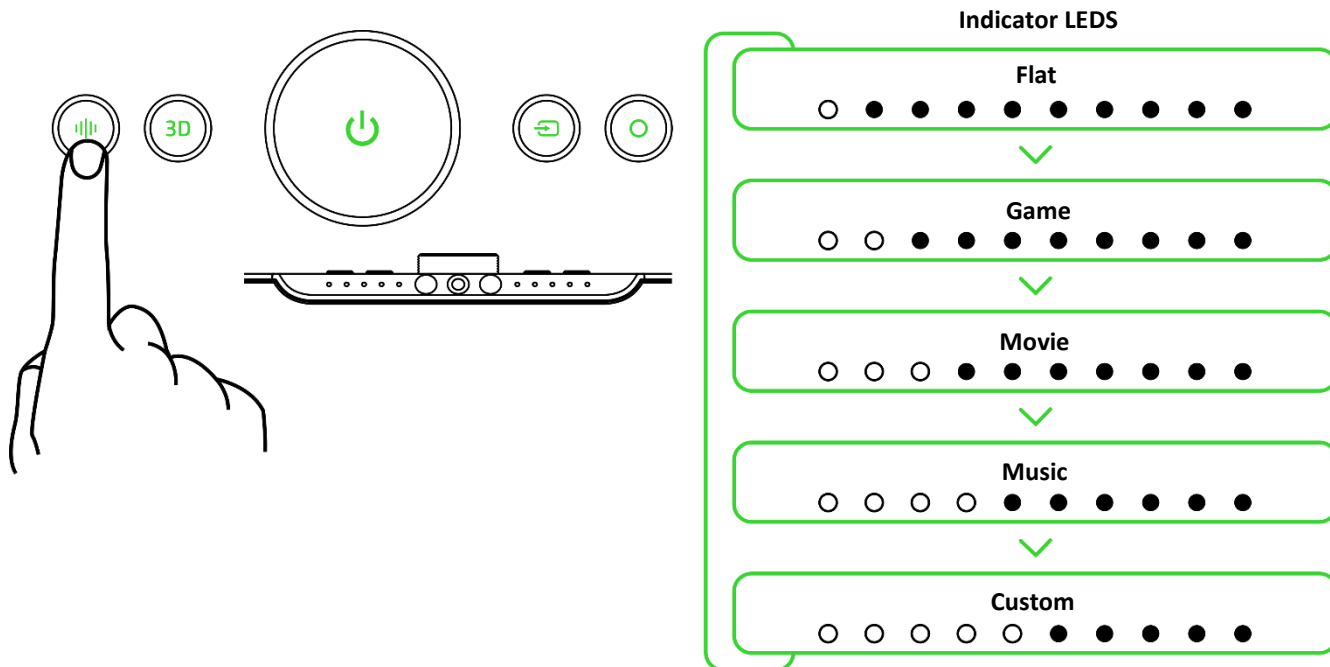

**i** You can also change the active EQ preset and personalize the Custom EQ preset using the Razer Audio app (mobile devices) and Razer Synapse app (PC). [Learn more about the Audio Equalizer](#)

## CYCLING BETWEEN AUDIO MODES

Press the Audio mode button to cycle through the Stereo, THX Spatial Audio – Virtual Headset, THX Spatial Audio - Virtual Speakers, and Room Fill audio modes. The indicator LEDs will briefly display which audio mode is currently active.

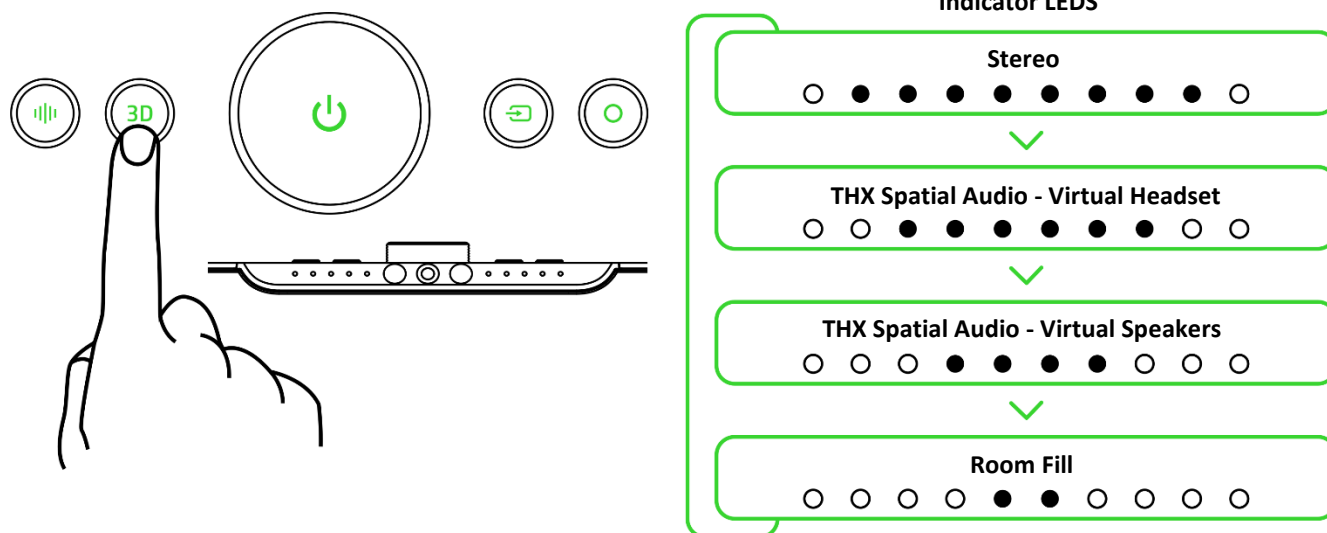

- **Stereo.** Delivers native sound without any processing.
- **THX Spatial Audio - Virtual Headset\***. Audio is beamed directly to your ears to deliver an immersive soundscape with pinpoint audio traditionally found in headsets. This audio mode is ideal for games and content with a binaural audio source.
- **THX Spatial Audio - Virtual Speakers\***. Audio is beamed to 7 virtual speakers to deliver a wide soundstage that is always centered around you. Use this audio mode for games and content with a multi-channel audio source.
- **Room Fill.** Audio is beamed to provide a wide and balanced soundscape over an extended listening area for multi-listeners.

**i** When under THX Spatial Audio Virtual Headset or THX Spatial Audio Virtual Speakers mode, all indicator LEDs will briefly fade in and out to indicate that the IR camera is actively detecting and tracking the position of your ears or will continuously diverge (in low brightness) if the IR camera cannot track your ears. You can also change the soundbar's audio mode using the Razer Audio app (mobile devices) and Razer Synapse app (PC). [Learn more about audio modes](#)

## ADJUSTING THE VOLUME

Rotate the volume control knob to adjust the volume of the soundbar. The indicator LEDs will briefly diverge as you increase the volume and converge as you decrease it.

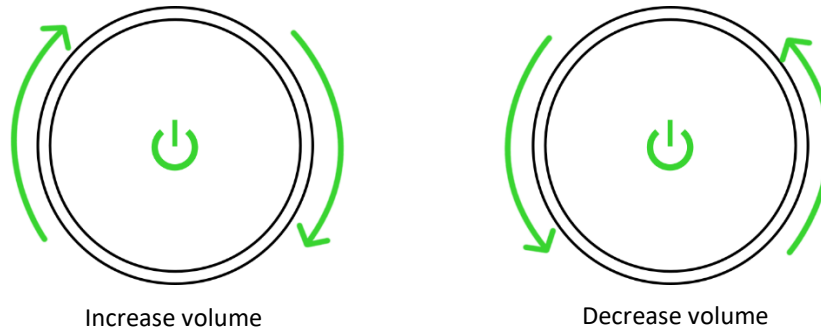

- i** When decreasing the volume, the two middle indicator LEDs will start blinking to indicate that the soundbar is already at its lowest volume.

## POWER ON/OFF

Press the Power button to power on or off the soundbar. All the soundbar's buttons will light up, and the Source button will display the current soundbar mode.

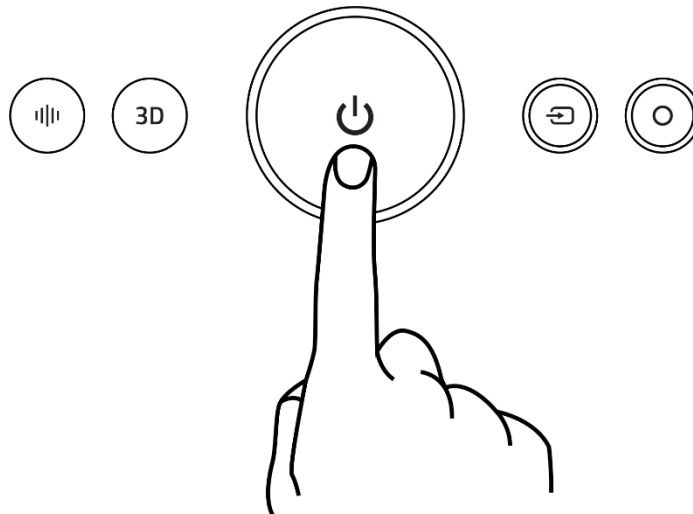

## SWITCHING BETWEEN SOUNDBAR MODES

Press the Source button to switch between PC and Bluetooth modes.

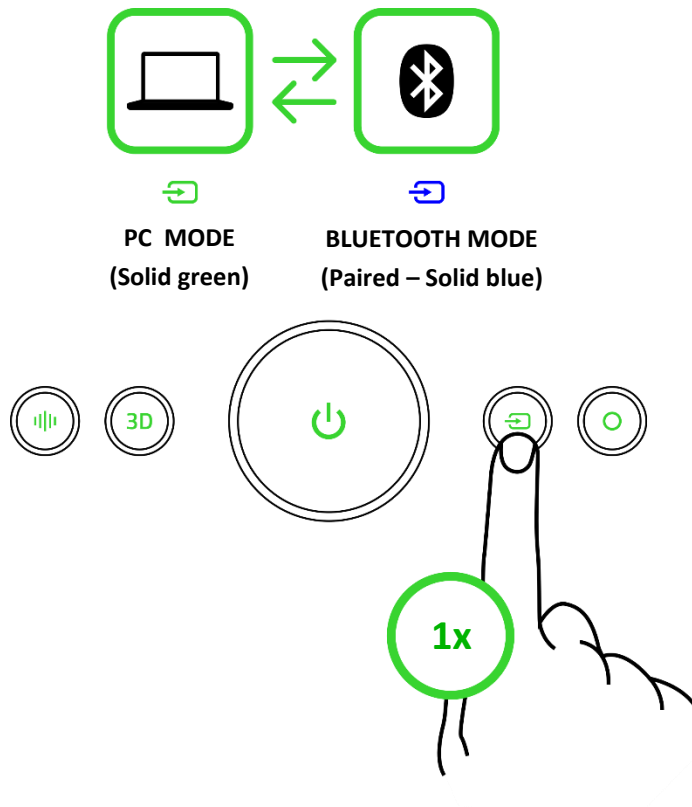

- i** Switching to Bluetooth mode will activate pairing mode when the soundbar is not paired to any device.

## REACTIVATING BLUETOOTH PAIRING MODE (FOR NEW DEVICES)

1. While in Bluetooth mode, press and hold the Source button for 4 seconds to activate pairing mode. The Source button will blink in blue, and the indicator LEDs will scroll back and forth to indicate that the soundbar is in pairing mode.

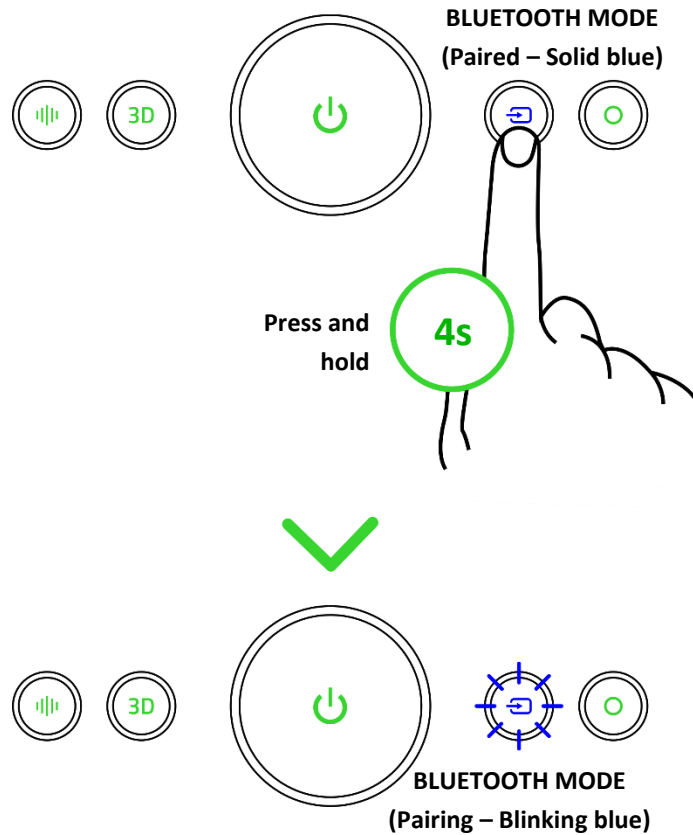

**i** Bluetooth pairing mode can only be activated from Bluetooth mode.

2. Activate Bluetooth on your device and select "Razer Leviathan V2 Pro (BT)" from the available devices.

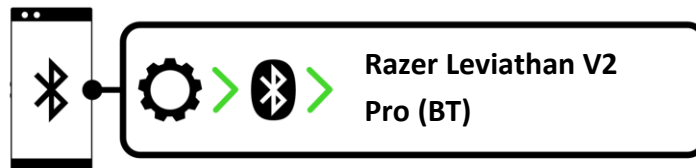

3. Wait until both devices are connected. The Source button will briefly show solid blue to indicate that the soundbar is now connected to your device.

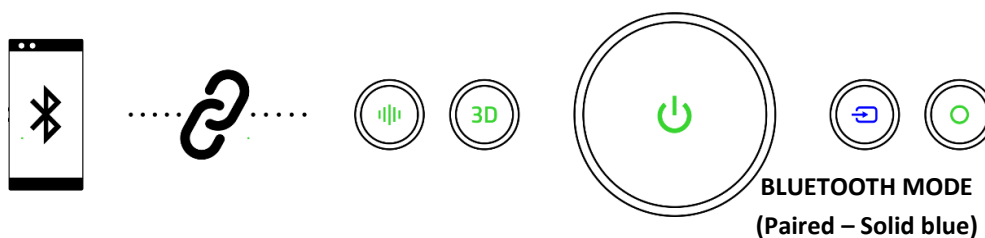

## TOGGLING BETWEEN SOUNDBAR AND HEADSET AUDIO OUTPUTS

While powered on, double press the Source button to toggle between soundbar and headset outputs. The Source button will blink in green if the soundbar is in PC mode or show solid cyan if the soundbar is in Bluetooth mode to indicate that the soundbar is using a connected headset as the audio output.

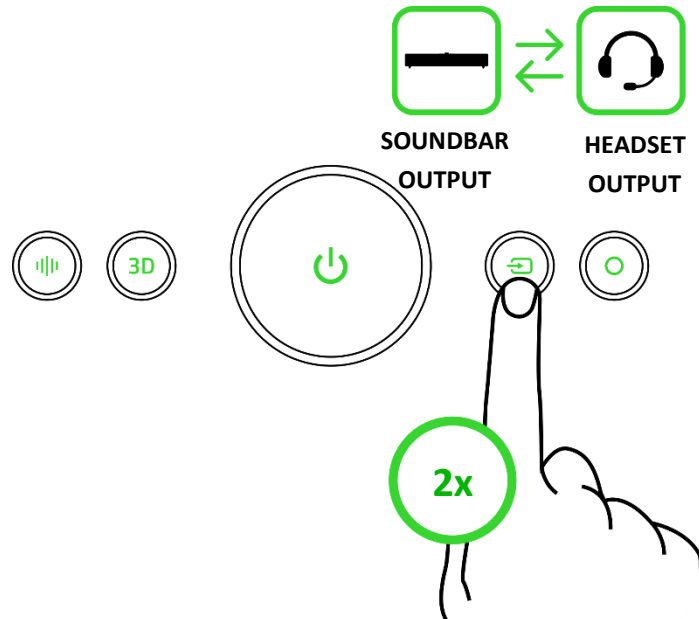

**i** You can also use the Razer Audio app (mobile device) or the Razer Synapse app (PC) to toggle between a soundbar and headset outputs.

## CYCLING THROUGH CHROMA EFFECTS

Press the Chroma button to cycle through the following lighting effects on the soundbar: Ambient awareness, Audio meter, Breathing, Fire, Spectrum cycling, Starlight, Static, and Wave.

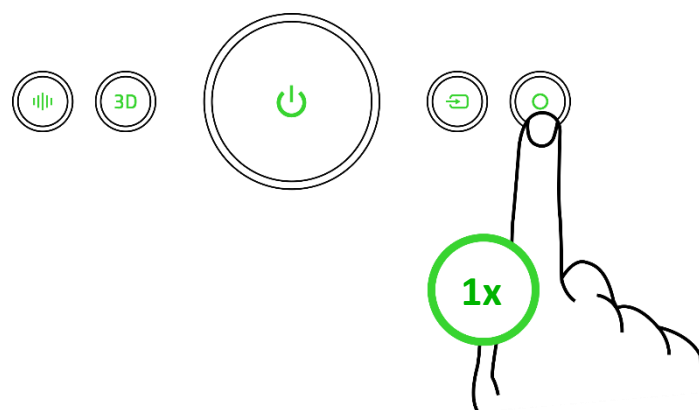

**i** Chroma lighting customizations made on Razer Synapse will only reflect on any Chroma effect when Razer Synapse is running.

## POWER ON/OFF THE SUBWOOFER

Press the Power button behind the subwoofer to power it on or off.

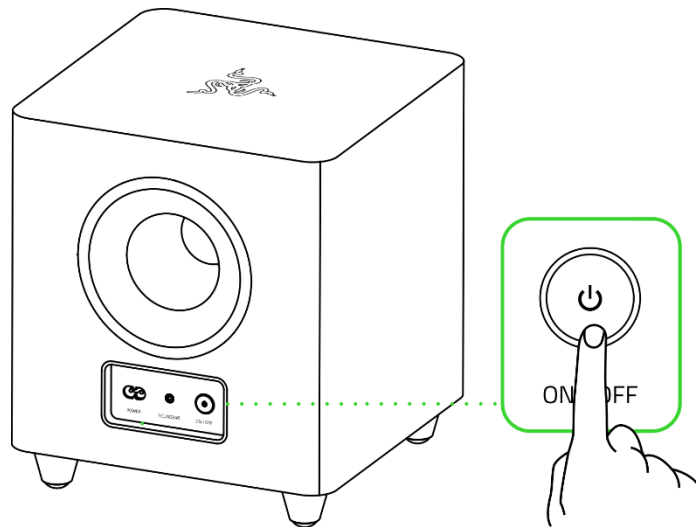

## PERSONALIZE YOUR EXPERIENCE

### Razer Synapse (PC)

Customize the soundbar's audio mode, EQ settings, Chroma lighting effect, and fine-tune other advanced features for an immersive audio experience that's genuinely yours.

**i** *Install Razer Synapse when prompted, or download the installer from [razer.com/synapse](https://razer.com/synapse)*

### Razer Audio app (Mobile devices)

Customize the soundbar's EQ settings and audio mode, conveniently toggle between connected audio devices, and even experience full RGB lighting customization from your mobile device.

**i** *Only available on iOS 14 / Android 10 (or higher) devices with Bluetooth connectivity*

---

## 8. CONFIGURING YOUR RAZER LEVIATHAN V2 PRO VIA RAZER SYNAPSE

**i** *Internet connection is required for installation, updates, and cloud-based features. Registering for a Razer ID account is recommended but optional. All listed features are subject to change based on the current software version, the connected device(s), and supported apps and software.*

### SYNAPSE TAB

The Synapse tab is your default tab when you first launch Razer Synapse. This tab allows you to navigate the Dashboard subtab.

#### Dashboard

The Dashboard subtab is an overview of your Razer Synapse, where you can access all your Razer devices, modules, and online services.

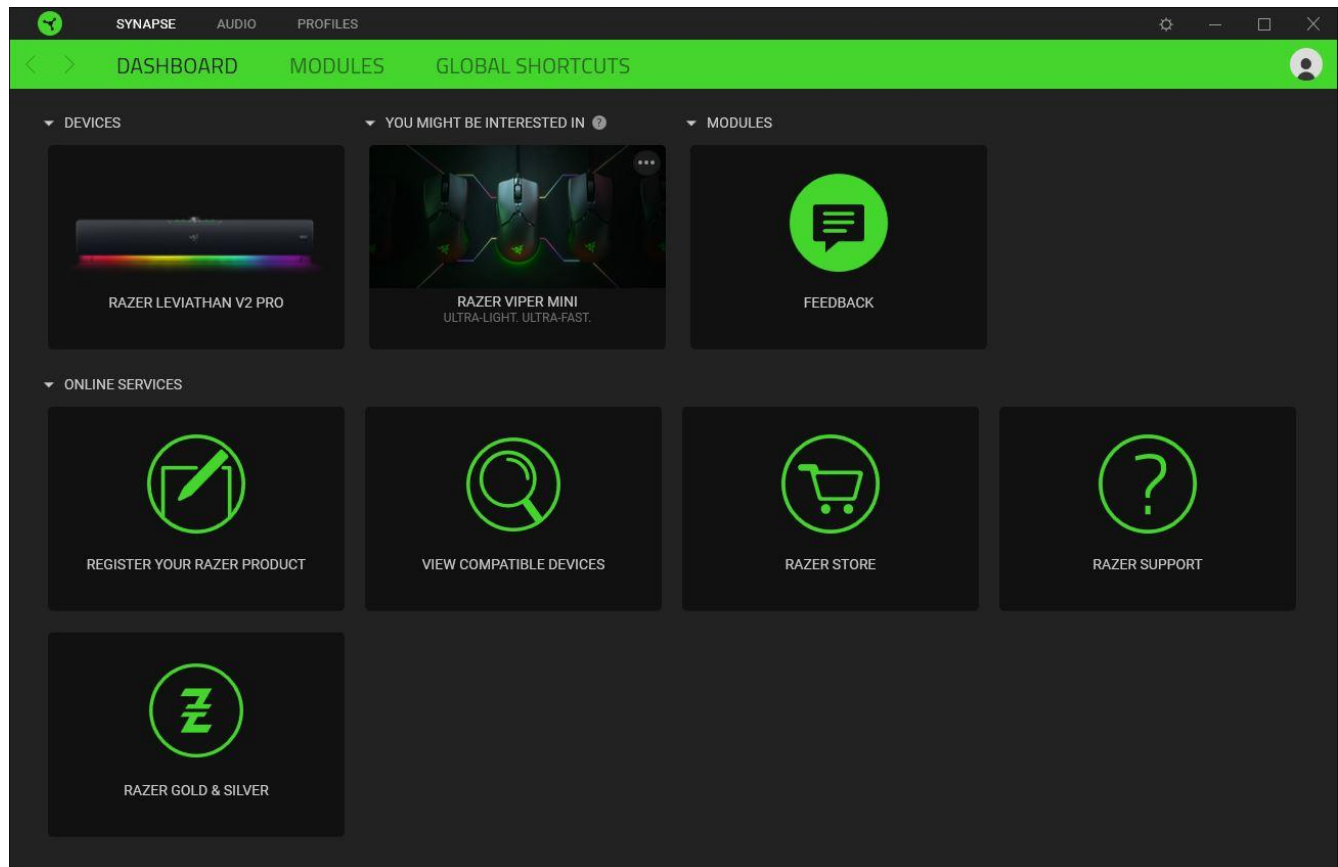

## Modules

The Modules subtab displays all installed and available modules for installation.

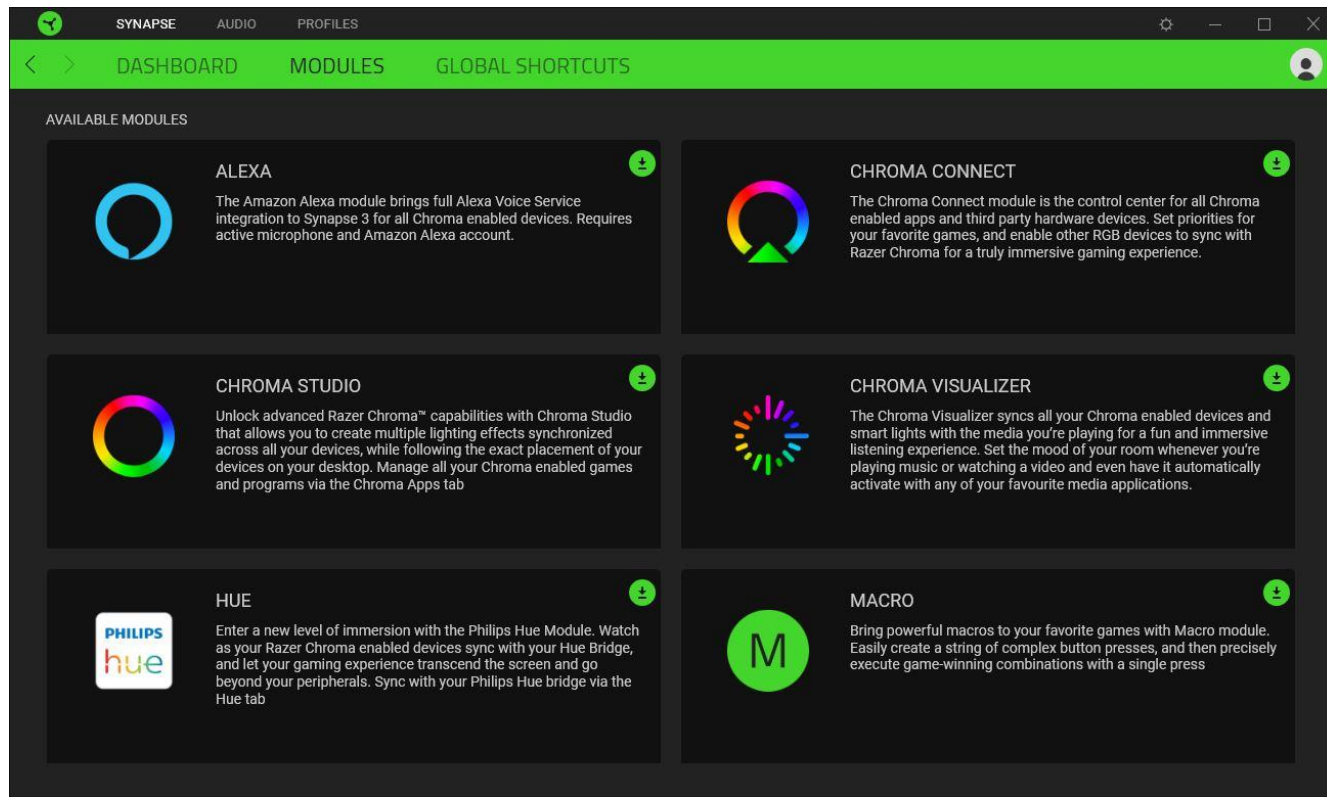

## Global Shortcuts

Bind operations or Razer Synapse functions to custom key-combinations from any Razer Synapse-enabled device inputs, which apply across all device profiles. [Learn more about Profiles](#)

 *Only Razer Synapse-enabled device inputs will be recognized.*

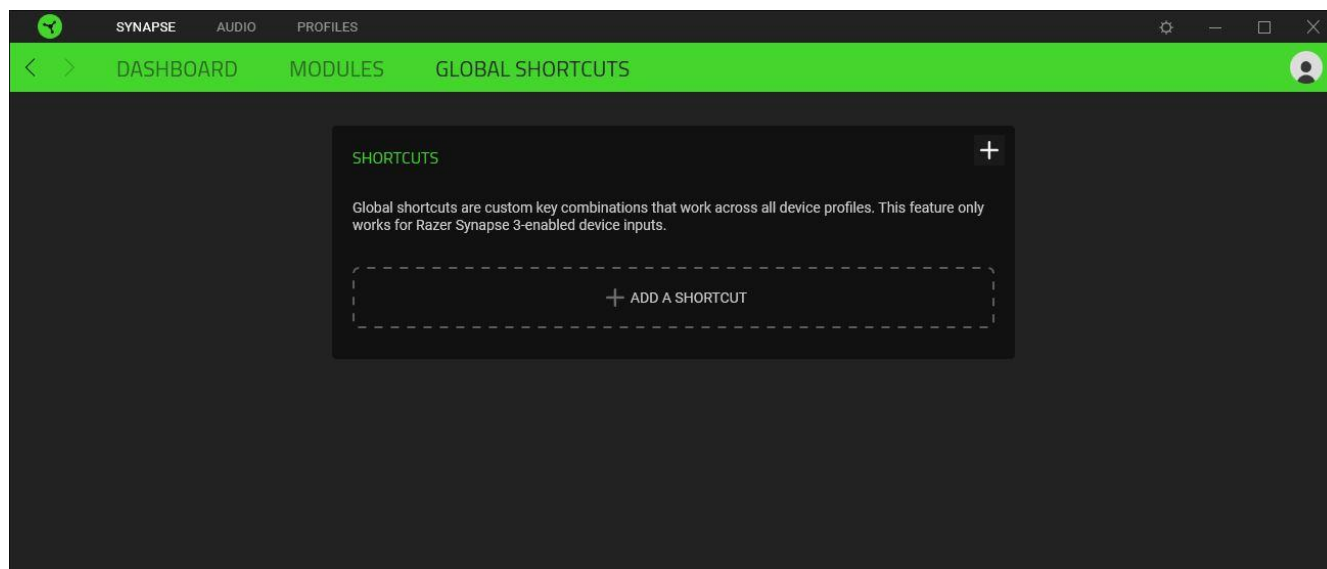

## AUDIO TAB

The Audio tab is the main tab for your Razer Leviathan V2 Pro, where you can customize your soundbar's settings to unleash its full potential. Changes made under this tab are automatically saved to your system and cloud storage.

### Sound

The Sound subtab is for adjusting the soundbar's volume and subwoofer intensity, toggling between soundbar and headset outputs, switching to Bluetooth audio source, and changing its audio modes.

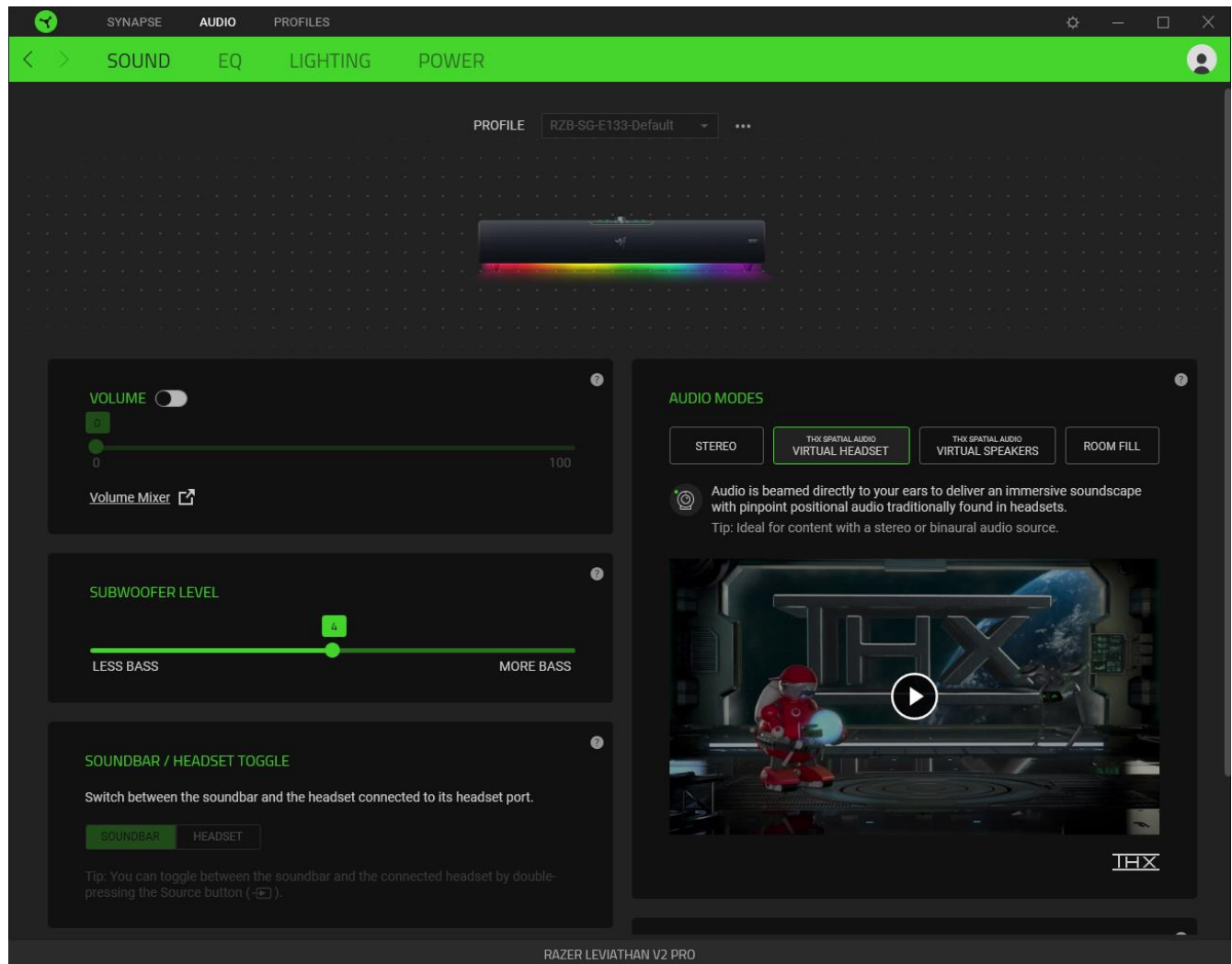

### Profile

A Profile is a data storage for keeping all your Razer peripherals' settings. By default, the profile name is based on your system's name. To add, rename, duplicate, or delete a profile, simply press the Miscellaneous button ( ●●● ).

### Volume

Adjust the audio volume of the soundbar. You may also access the Windows volume mixer of the current playback device, where you can proportionally adjust the overall volume of the system or individually adjust the volume of each active application.

### Subwoofer level

Fine-tune the intensity of the subwoofer's output using the bass level slider.

### Soundbar / Headset toggle

Toggle between soundbar output and headset outputs when a headset is connected to the headset port. Alternatively, you can also toggle between outputs by double pressing the Source button.

### Input source

Allows you to switch the soundbar to Bluetooth mode using Razer Synapse.

 *Razer Synapse won't be able to revert to PC mode when the soundbar has been set to Bluetooth mode. To set the soundbar to PC mode, press the Source button.*

### Audio modes

Change the soundbar's audio modes using the provided options to elevate your listening experience.

 *Head-tracking is only enabled on THX Spatial Audio - Virtual Headset and THX Spatial Audio - Virtual Speakers modes.*

### Sound Properties

Launches the Windows Sound Properties window where you can manage your system's sound settings, such as modifying the playback and recording device settings, sound scheme, and default communications activity.

## EQ

Use the EQ subtab to customize the frequency response of the soundbar or normalize the loudness of audio to avoid unpleasant increases in volume.

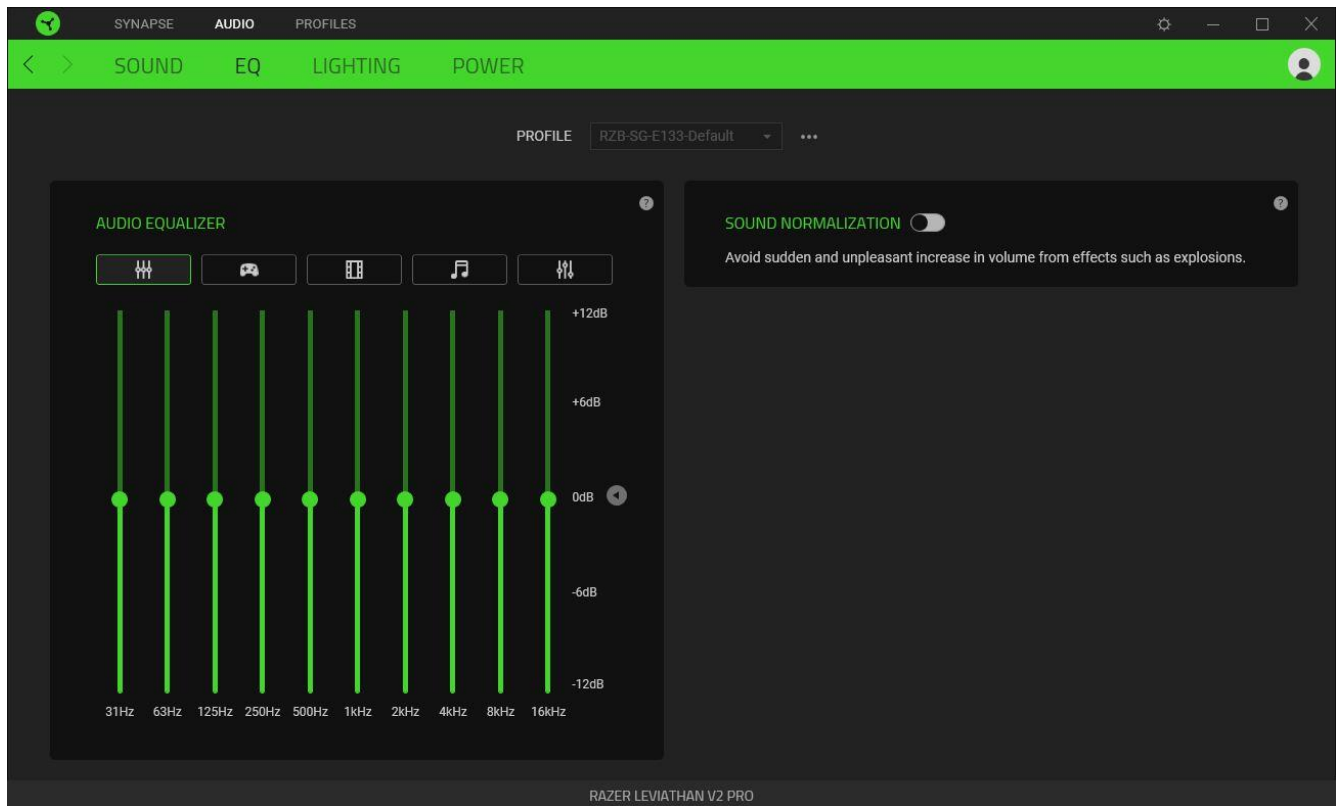

### *Audio equalizer*

Select any available equalizer preset created for the best audio experience designed for balance, gaming immersion, movie viewing, or enjoying your favorite music. Manually adjusting any equalizer preset will automatically set it to Custom.

### *Sound normalization*

When enabled, the soundbar will normalize the loudness of audio and avoid sudden and unpleasant increases in volume from sound effects such as explosions.

## Lighting

The Lighting subtab enables you to customize the lighting on the soundbar.

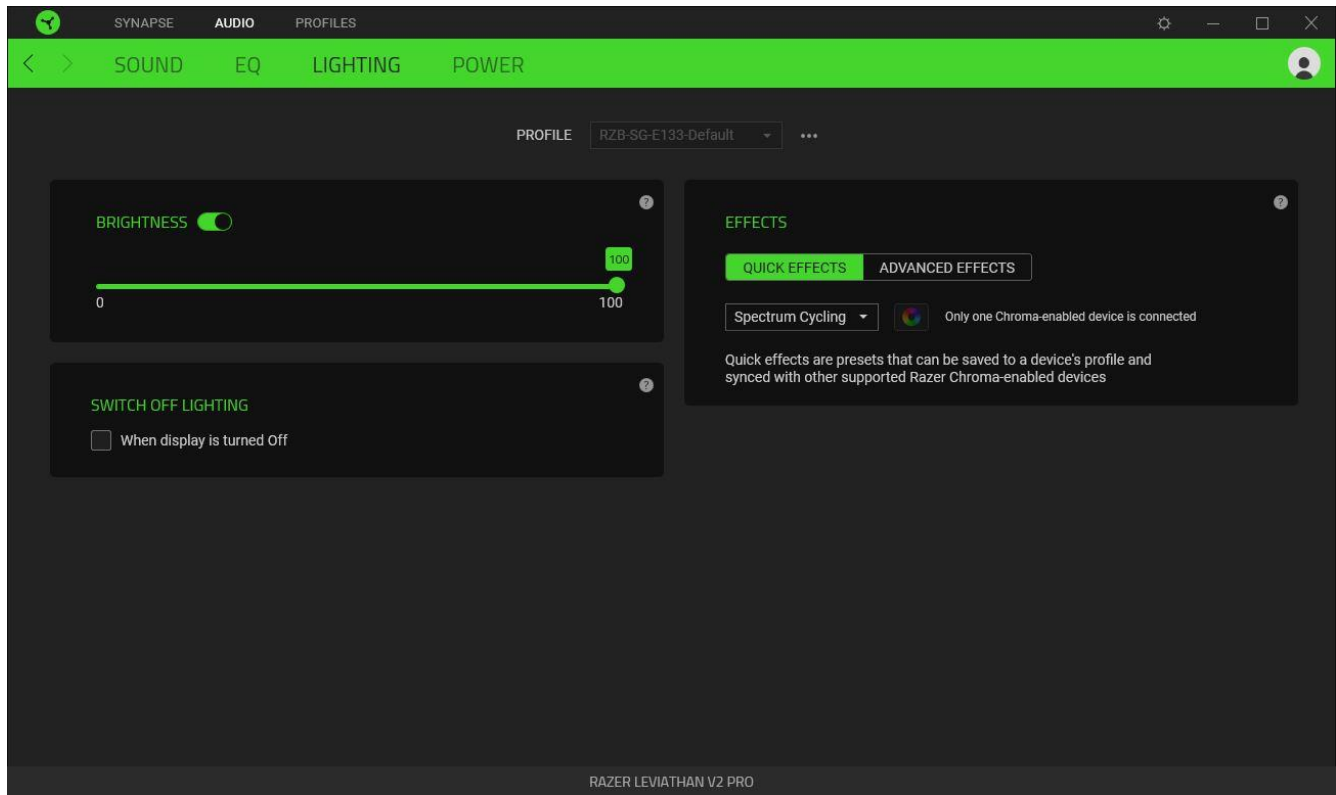

### Brightness

You can turn off the soundbar lighting by toggling the Brightness option or increase/decrease the luminance using the slider.







### Switch Off Lighting

This power-saving tool allows you to disable soundbar lighting when your system's display is turned off.

### Quick Effects

Several quick effects can be selected and applied to your soundbar's lighting, as listed here:

	Name	Description	How to set up
	Ambient awareness	The soundbar lighting will reflect the averaged color on the selected screen region	Select a screen region

	Audio meter	The LEDs will light up according to the audio level with a default spectrum of colors	Select a Color Boost level
	Breathing	The soundbar lighting will fade in and out of the selected color(s)	Select up to 2 colors or randomize colors
	Fire	The soundbar lighting will mimic the motion of flames	No further customization required
	Spectrum cycling	The soundbar lighting will cycle between 16.8 million colors indefinitely	No further customization required
	Starlight	Each LED on the soundbar lighting will have a chance of fading in and out at a random time and duration	Select up to 2 colors or randomize colors and select a duration
	Static	The soundbar lighting will remain lit in the selected color	Select a color
	Wave	The soundbar lighting will scroll in the direction selected	Select either left-to-right or right-to-left wave direction

If you have other supported Razer Chroma-enabled devices, you can synchronize their quick effects with your Razer device by clicking the Chroma Sync button (  ).

 *Only devices that support the selected lighting effect will synchronize.*

### Advanced Effects

The Advanced Effects option allows you to choose a Chroma Effect you want to use on your Razer Chroma-enabled peripheral. To start making your own Chroma Effect, simply press the Chroma Studio button (  ).

## Power

Use the Power subtab to enable the soundbar to enter standby mode when idle for a certain period.

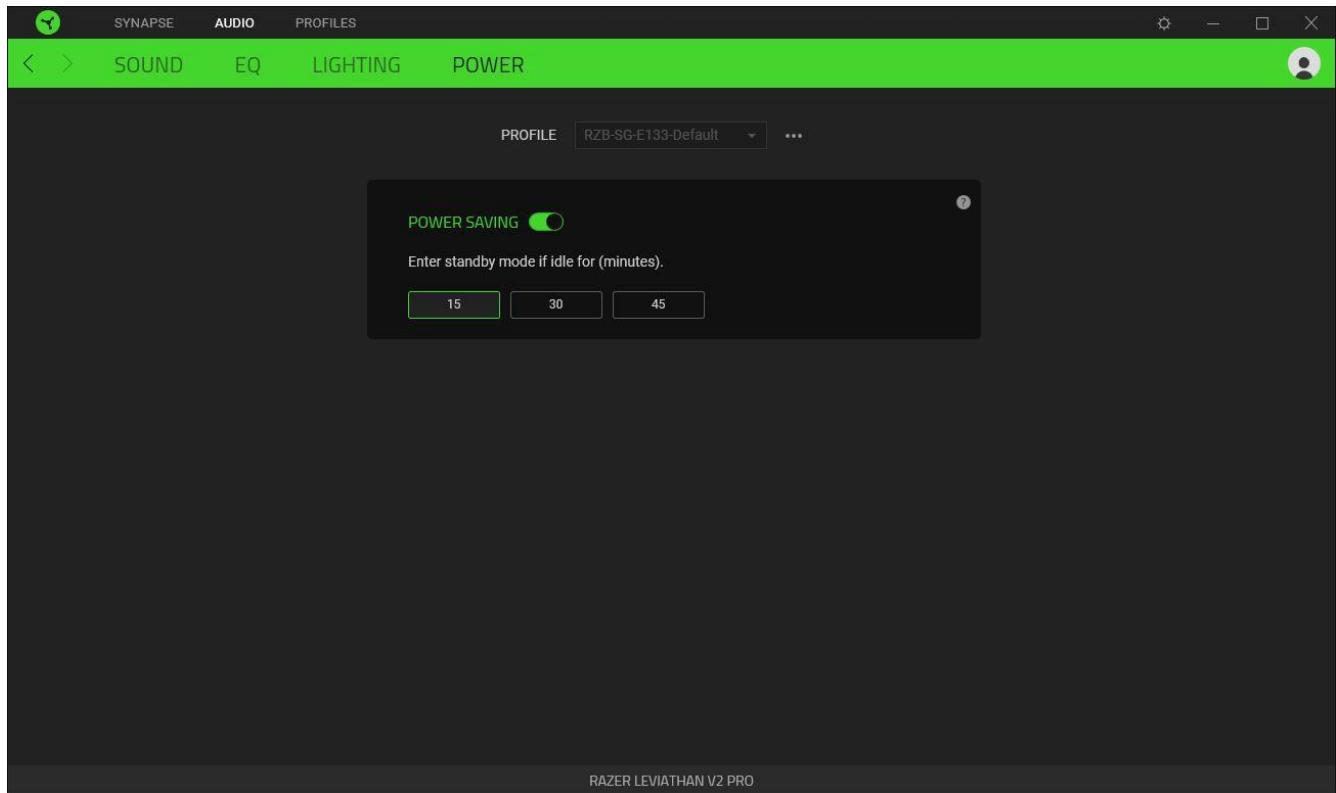





## PROFILES TAB

The Profiles tab is a convenient way to manage all your profiles and link them to your games and applications.

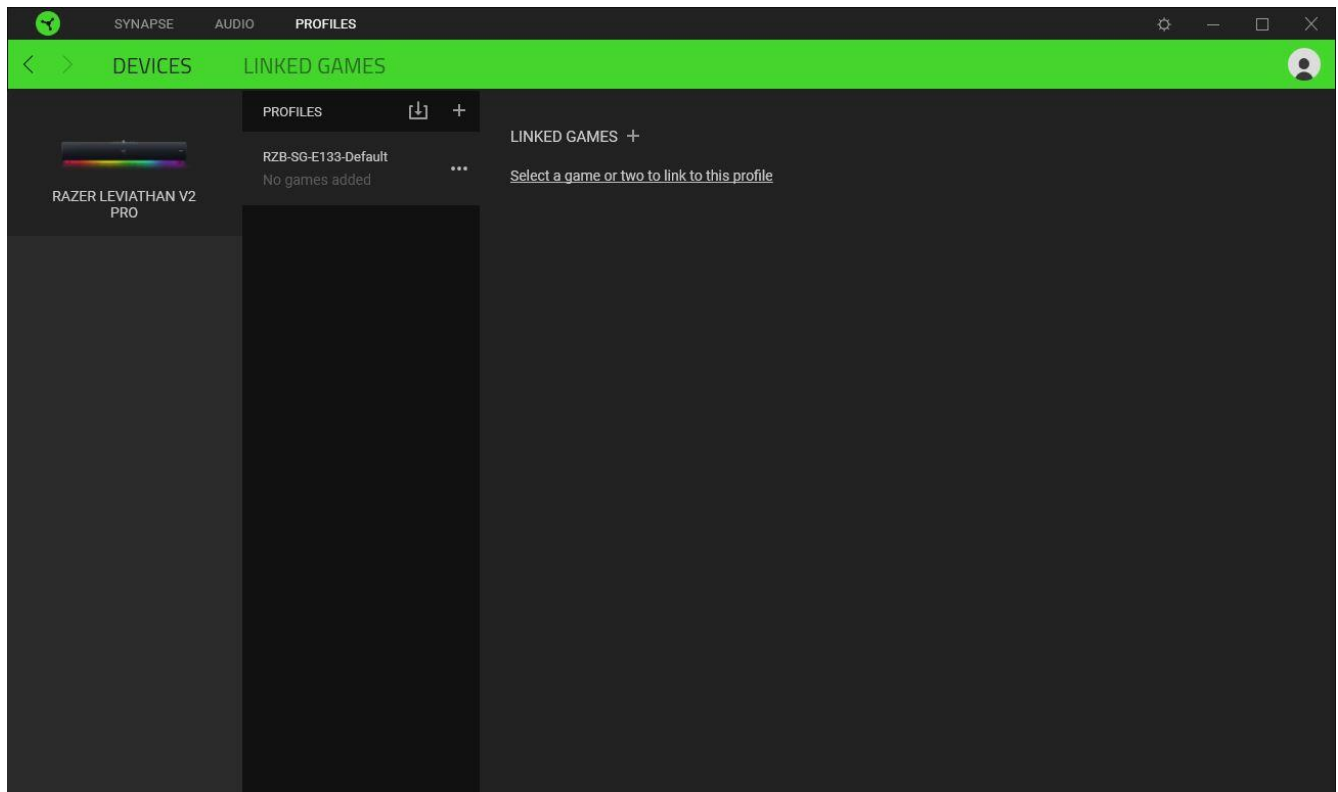
### Devices

View which games are linked to each device's profiles or which Chroma Effect is linked to specific games using the Devices subtab.



You can import Profiles from your computer or the cloud through the import button (  ) or create new profiles within the selected device using the add button (  ). To rename, duplicate, export, or delete a profile, simply press the Miscellaneous button (  ). Each profile can be set to activate when you run an application using the Linked Games option.

## Linked Games

The Linked Games subtab allows you to add games, view devices linked to games, or search for added games. You can also sort games based on alphabetical order, last played, or most played. Added games will still be listed here, even if they are not linked to a Razer device.

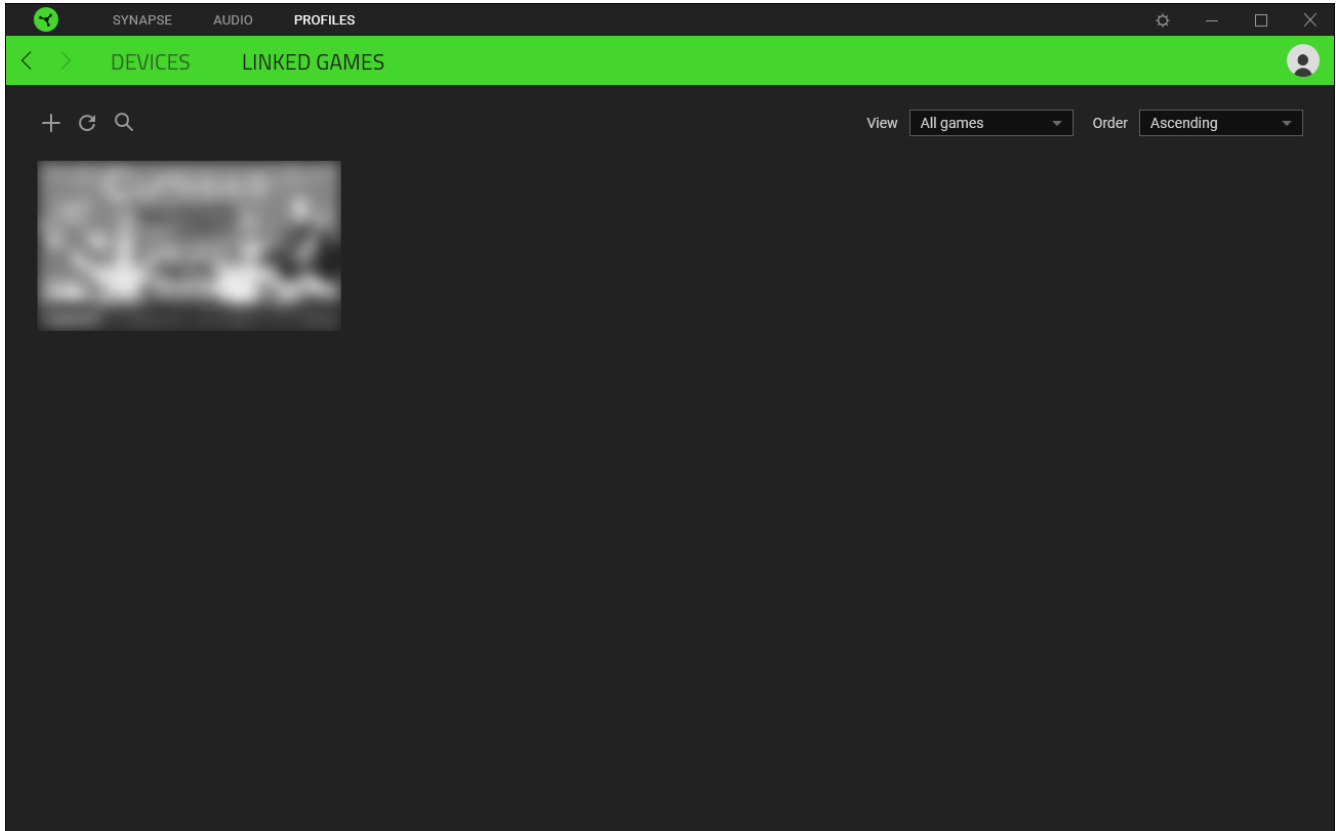

To link games to connected Razer devices or Chroma Effects, click on any game from the list, and then click **Select a device and its profile to launch automatically during gameplay** to select the Razer device or Chroma Effect it will link with. Once connected, you may click the Miscellaneous button ( ●●● ) of the corresponding Chroma Effect or device to select a specific Chroma Effect or profile.

## SETTINGS WINDOW

The Settings window, accessible by clicking the ( ⚙ ) button on Razer Synapse, enables you to configure the startup behavior and display language of Razer Synapse, view the master guides of each connected Razer device, or perform a factory reset on any connected Razer device.

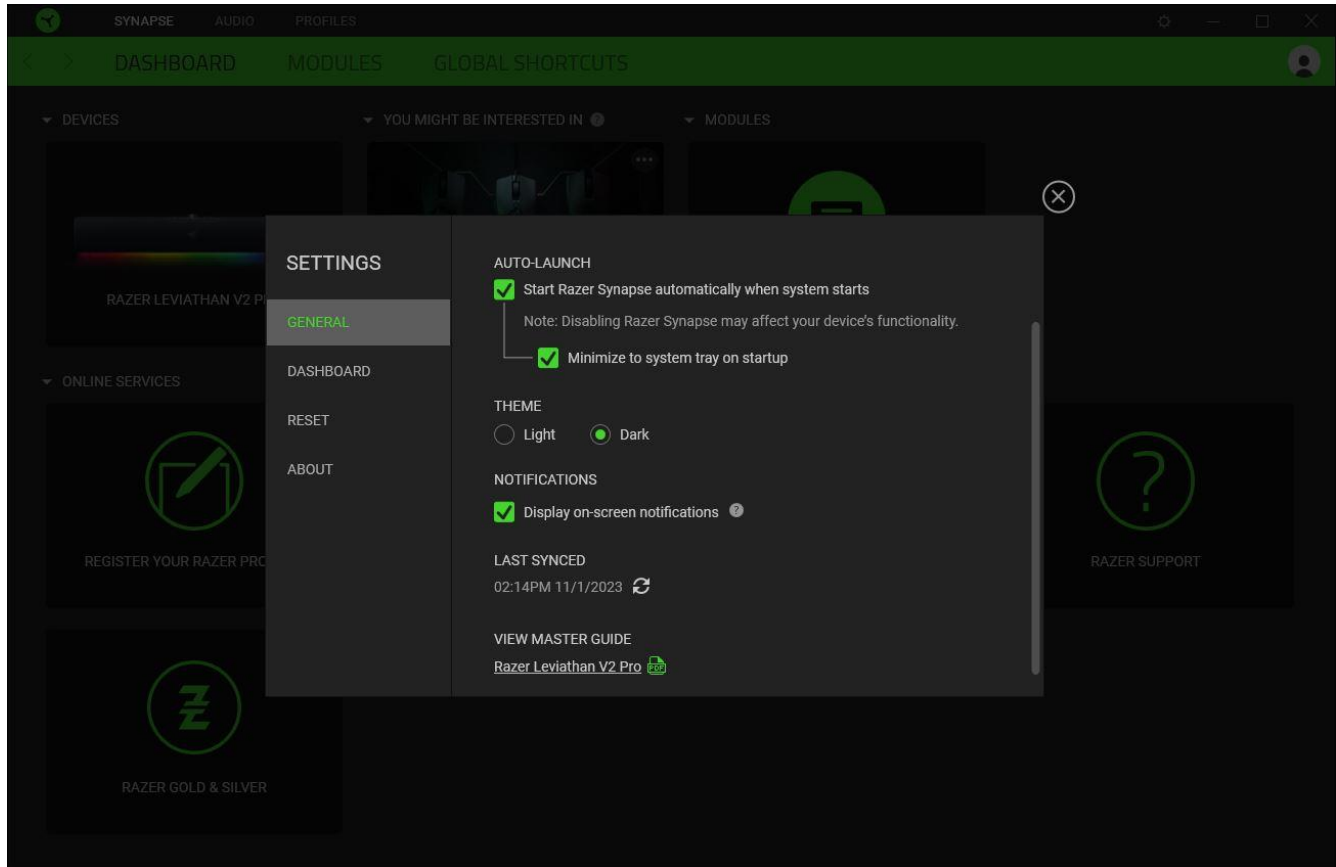

### General tab

The General tab lets you change the software's display language, startup behavior, theme, and on-screen notifications. You may also manually sync your profiles to the cloud ( ↻ ) or view the master guide of all connected Razer devices and installed modules.

### Dashboard tab

Use the Dashboard tab to customize which Razer device recommendations based on your setup, and the games you play will appear on the Dashboard.

### Reset tab

The Reset tab allows you to perform a factory reset on all connected Razer devices with on-board memory and/or reset Razer Synapse tutorials to acquaint yourself again with Razer Synapse's new features on its next launch.



*All profiles stored on the selected device's on-board memory will be erased when you reset a Razer device.*

## About tab

The About tab displays brief software information and copyright statement, and provides relevant links for its terms of use. You may also use this tab to check for software updates, or as quick access to Razer's social communities.

---

## 9. SAFETY AND MAINTENANCE

---

### WARNING

- Use the appropriate power cord for your region when plugging a power cord into the soundbar and subwoofer.
- If you detect any hazard risk on the soundbar or subwoofer, immediately unplug the power cord from the power outlet.

---

### SAFETY GUIDELINES

To achieve maximum safety while using your Razer Leviathan V2 Pro, we suggest that you adopt the following guidelines:

- Should you have trouble operating the device properly and troubleshooting does not work, unplug the device and contact the Razer hotline or go to [support.razer.com](https://support.razer.com) for assistance.
- Don't take apart the device, and don't attempt to operate it under abnormal current loads. Doing so will void your warranty.
- Don't insert foreign objects into the soundbar or subwoofer's openings.
- When placing the soundbar and subwoofer, position each component on a fully leveled surface.
- Keep the device away from liquid, humidity or moisture. Operate the device only within the specific temperature range of 0°C (32°F) to 40°C (104°F). Should the temperature exceed this range, unplug and/or switch off the device to stabilize the temperature to an optimal level.
- Listening to excessively loud volumes over extended periods can damage your hearing. Furthermore, legislation of certain countries permits a maximum sound level of 86db to affect your hearing for 8 hours a day. We, therefore, recommend that you reduce the volume to a comfortable level when listening for prolonged periods. Please, take good care of your hearing.

### MAINTENANCE AND USE

The Razer Leviathan V2 Pro requires minimum maintenance to keep it in optimum condition. Once a month, we recommend cleaning the soundbar and subwoofer using a soft cloth or cotton swab to prevent dirt buildup. Don't use soap or harsh cleaning agents.

---

## 10. LEGALESE

### COPYRIGHT AND INTELLECTUAL PROPERTY INFORMATION

©2023 Razer Inc. All rights reserved. Razer, the triple-headed snake logo, Razer logo, "For Gamers. By Gamers.", and "Razer Chroma" logo are trademarks or registered trademarks of Razer Inc. or affiliated companies in the United States and other countries. All other trademarks are the property of their respective owners.

Android, Google, Google Logo, Google Play, and the Google Play logo are registered trademarks of Google LLC.

Apple, the Apple logo, and iPhone are trademarks of Apple Inc., registered in the U.S. and other countries. App Store is a service mark of Apple Inc. iOS is a trademark or registered trademark of Cisco in the U.S. and other countries and is used under license.

The Bluetooth® word mark and logos are registered trademarks owned by Bluetooth SIG, Inc., and any use of such marks by Razer is under license.

THX and the THX Logo are the property of THX Ltd., registered in the U.S. and other countries.

Windows and the Windows logo are trademarks of the Microsoft group of companies.

Razer Inc. ("Razer") may have copyright, trademarks, trade secrets, patents, patent applications, or other intellectual property rights (whether registered or unregistered) concerning the product in this guide. Furnishing of this guide does not give you a license to any such copyright, trademark, patent or other intellectual property right. The Razer Leviathan V2 Pro (the "Product") may differ from pictures whether on packaging or otherwise. Razer assumes no responsibility for such differences or for any errors that may appear. Information contained herein is subject to change without notice.

### LIMITED PRODUCT WARRANTY

For the latest and current terms of the Limited Product Warranty, please visit [razer.com/warranty](https://www.razer.com/warranty).

### LIMITATION OF LIABILITY

Razer shall in no event be liable for any lost profits, loss of information or data, special, incidental, indirect, punitive or consequential or incidental damages, arising in any way out of distribution of, sale of, resale of, use of, or inability to use the Product. In no event shall Razer's liability exceed the retail purchase price of the Product.

## GENERAL

These terms shall be governed by and construed under the laws of the jurisdiction in which the Product was purchased. If any term herein is held to be invalid or unenforceable, then such term (in so far as it is invalid or unenforceable) shall be given no effect and deemed to be excluded without invalidating any of the remaining terms. Razer reserves the right to amend any term at any time without notice.