



RAZER AETHER LAMP

MASTER GUIDE

Make your gamer room truly shine with Razer Aether Lights. Powered by Razer Chroma™ RGB, customize and control them all from one convenient app to create the perfect setting for any scenario.

CONTENTS

1. WHAT'S INSIDE	3
2. WHAT'S NEEDED	4
3. LET'S GET YOU COVERED.....	5
4. TECHNICAL SPECIFICATIONS	5
5. GETTING STARTED.....	6
6. CUSTOMIZING THE LAMP	7
7. USING THE LAMP	9
8. CONFIGURING YOUR RAZER AETHER LAMP VIA RAZER SYNAPSE	11
9. SAFETY AND MAINTENANCE	22
10. LEGALESE.....	23

1. WHAT'S INSIDE

- Razer Aether Lamp

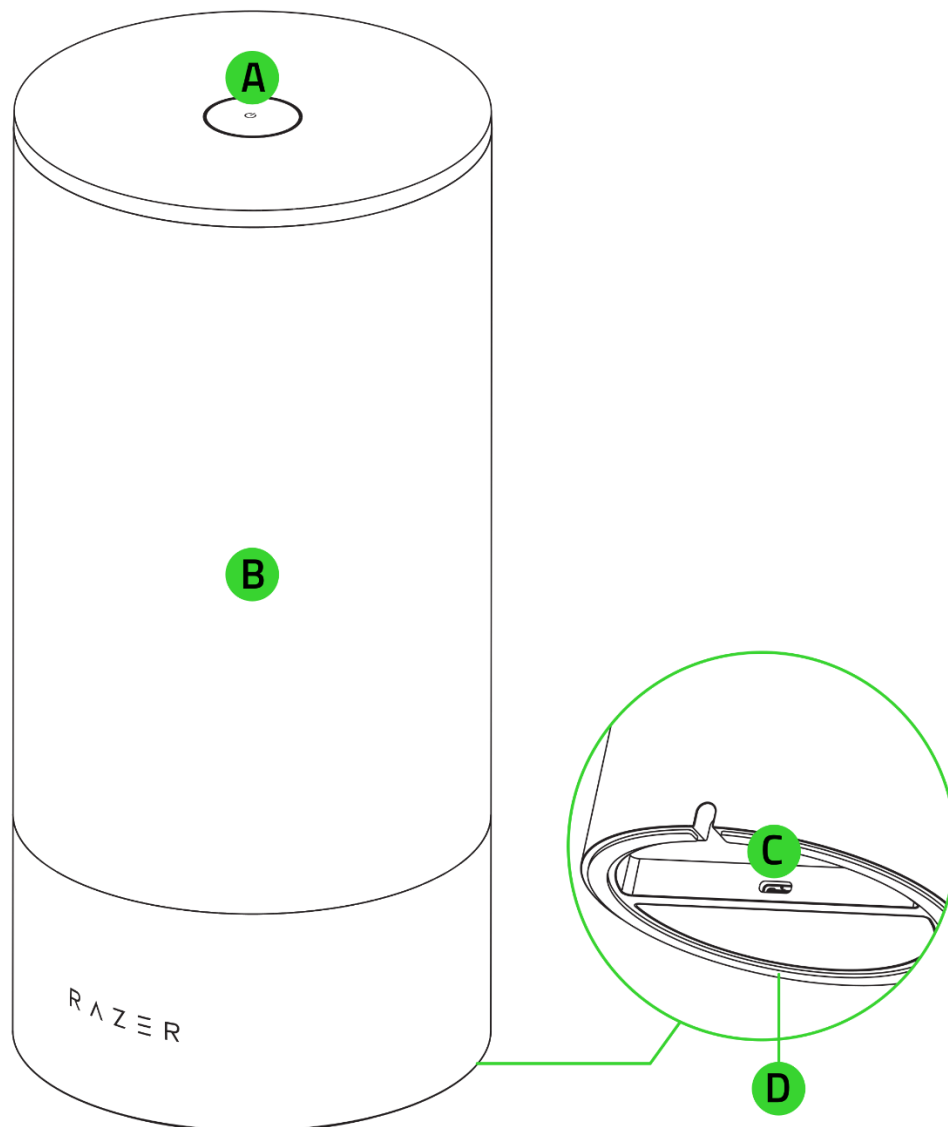

- A. Multi-function button
- B. Lamp body powered by Razer Chroma™ RGB
- C. Power port
- D. Non-slip rubber footing

- Power adapter with interchangeable plugs*

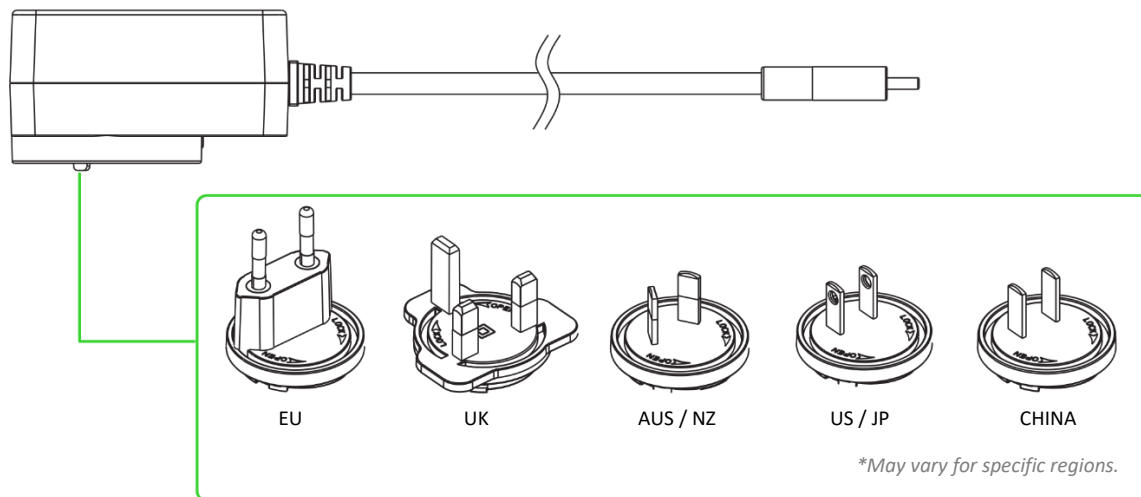

- Important Product Information Guide

2. WHAT'S NEEDED

PRODUCT REQUIREMENTS

- 2.4 GHz WiFi network (WPA / WPA2 encryption)
- WiFi-enabled PC / Laptop (Windows® 10 64-bit or higher) or iOS / Android device**

RAZER GAMER ROOM APP REQUIREMENTS

- iOS 16.4 / Android 9 Pie (or higher) device with Bluetooth connectivity**
- Internet connection for app installation

RAZER SYNAPSE REQUIREMENTS

- Windows® 10 64-bit (or higher)
- Internet connection for software installation

***Bluetooth connectivity required for initial setup only.*

3. LET'S GET YOU COVERED



Register your product and score exclusive benefits

razerid.razer.com/warranty

*Your product's
serial number can
be found here.*

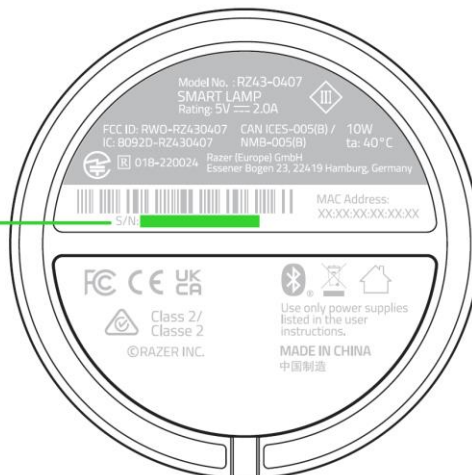

4. TECHNICAL SPECIFICATIONS

- White color temperature: 2700 – 6500K
- RGB lighting: Razer Chroma RGB
- Luminous flux: 300 lm
- LED lifetime: 25,000 hours
- Rated power: 10W
- Input voltage: 5V

- Connection protocol: 802.11b/g/n 2.4GHz
- Voice assistant: Amazon Alexa, Google Assistant
- Pairing: Bluetooth
- Works with Matter™
- Power Adapter
 - Input 100-240V-50/60Hz
 - Output: 5V 2A (10W)

5. GETTING STARTED

SETTING IT UP

Attach the correct AC plug for your region to the power adapter, then connect it to the lamp's power port and plug it into a power outlet.

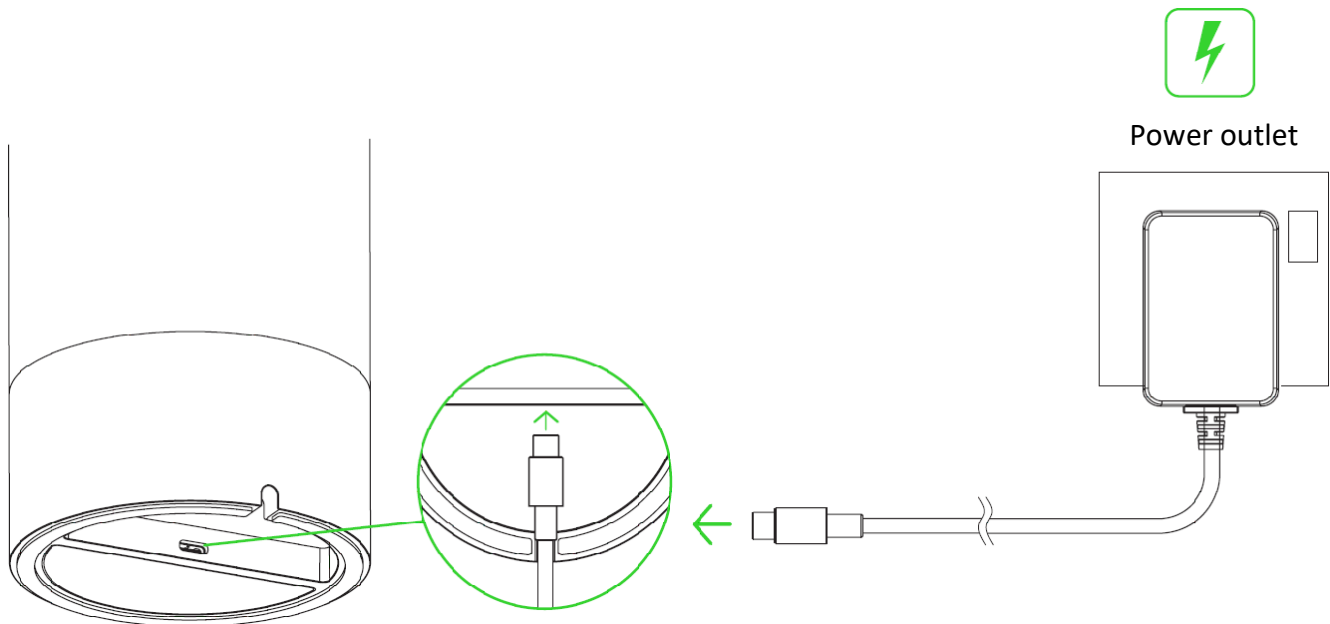

6. CUSTOMIZING THE LAMP

A. VIA MOBILE DEVICE USING THE RAZER GAMER ROOM APP (REQUIRED)

1. Download the Razer Gamer Room app on your mobile device.



Razer Gamer Room



RZR.TO/GAMER-ROOM-APP



2. Press the multi-function button to power on the lamp.

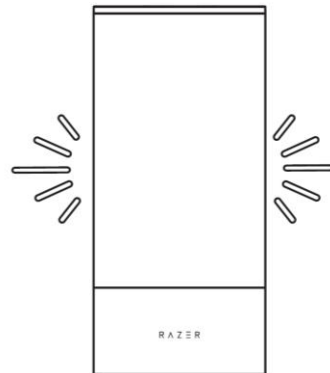

3. Launch the app, follow the onscreen instructions and scan the Matter™ QR code on the lamp.

 *Please make sure that your mobile device is on your preferred 2.4 GHz network.*

You can now customize the Razer Aether Lamp using the Razer Gamer Room app.

B. VIA PC / LAPTOP USING THE RAZER SYNAPSE APP

 *Before proceeding, make sure the lamp is already set up on your network (via the Razer Gamer Room app) and your PC is on the same network.*

1. Go to [razer.com/synapse](https://www.razer.com/synapse) to download and launch Razer Synapse. For existing users, update Razer Synapse to its latest version.

 *Registering for a Razer ID account is recommended but optional. You may continue as a guest; however, you won't be able to store any of your settings on the cloud.*

2. Press the multi-function button to power on the lamp.

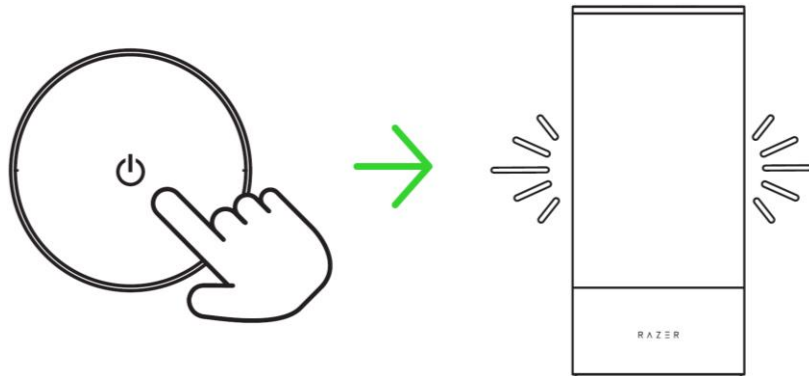

3. On Razer Synapse, click **Add WiFi Device**, choose **Gamer Room Devices**, select your device, and follow the onscreen instructions.

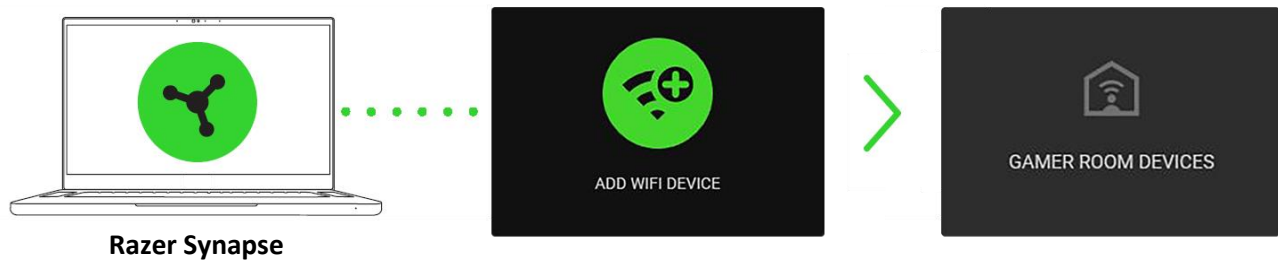

4. Update when prompted, and wait for Razer Synapse to set up the Razer Aether Lamp. The Razer Synapse Dashboard will show the Razer Aether Lamp on the Devices list.



You can now customize the Razer Aether Lamp using Razer Synapse.

UNDERSTANDING PAIRING MODE

Pairing mode is required when setting up the lamp from the Razer Gamer Room app. It activates when you power on the lamp and deactivates after 5 minutes if the lamp remains unpaired. To reactivate pairing mode, switch off and on the lamp's power supply.

7. USING THE LAMP

MULTI-FUNCTION BUTTON FUNCTIONS

Power on/off

Press the multi-function button to power on or off the lamp.

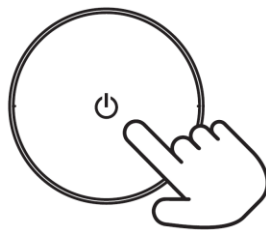

Changing the lighting effect

While powered on, press and hold the multi-function button to cycle through Cool white, Neutral white, Warm white, Static colors, and Spectrum cycling lighting effects.

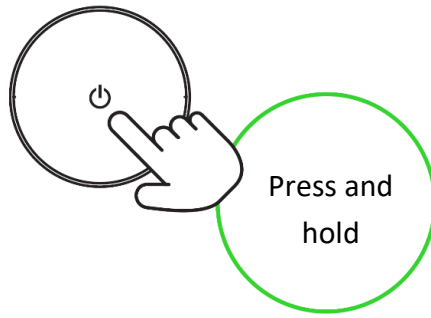

Releasing the multi-function button on the preferred lighting effect will set it as the lamp's active effect.

Effect	Description
Cool white	The lamp will be lit in white with a hint of blue, white, or white with a hint of yellow.
Neutral white	
Warm white	
Static colors	The lamp will be lit using the following colors: red, orange, yellow, green, cyan, blue, or purple.
Spectrum cycling	The lighting will cycle through a default spectrum of colors.

Resetting to factory settings

Once connected, a reset is required to connect the lamp to a new device.

1. Switch off the lamp's power supply.

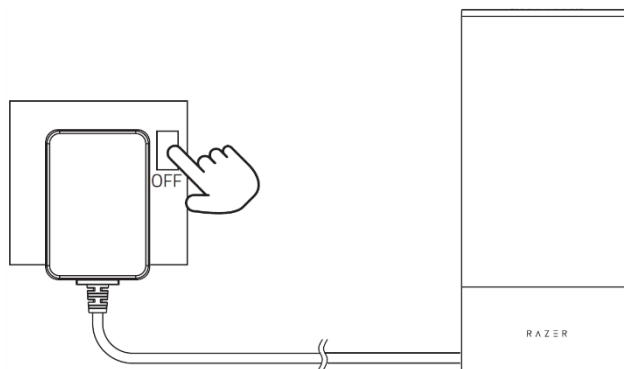

2. While holding the multi-function button, switch on the power supply and continue holding the multi-function button for 4 seconds.

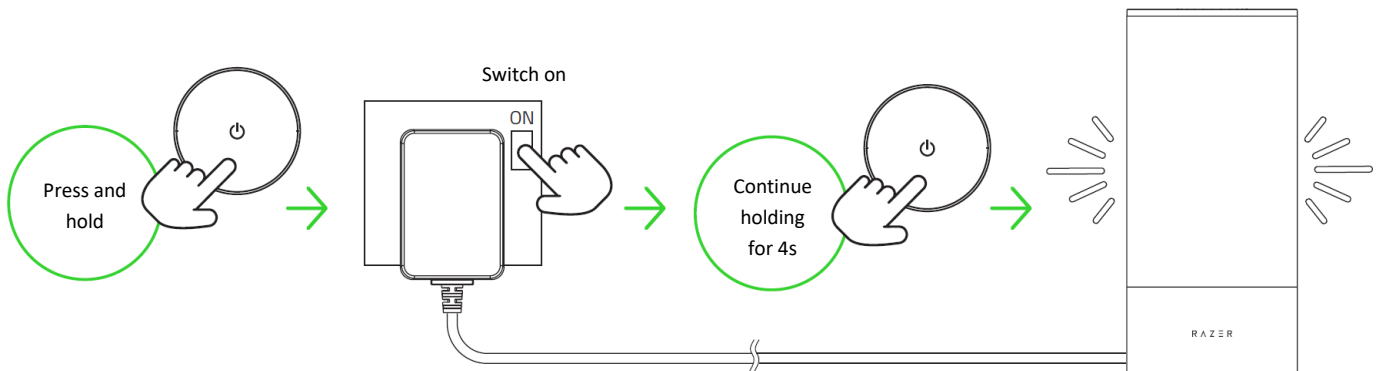

The lamp will briefly cycle through red, green, and blue before displaying white when the reset is successful.

3. Use the Razer Gamer Room app to connect the Razer Aether Lamp to a new mobile device.

8. CONFIGURING YOUR RAZER AETHER LAMP VIA RAZER SYNAPSE

i *Internet connection is required for installation, updates, and cloud-based features. Registering for a Razer ID account is recommended but optional. All listed features are subject to change based on the current software version, the connected device(s), and supported apps and software.*

SYNAPSE TAB

The Synapse tab is your default tab when you first launch Razer Synapse. This tab allows you to navigate the Dashboard subtab.

Dashboard

The Dashboard subtab is an overview of your Razer Synapse, where you can access all your Razer devices, hardware recommendations, modules, and online services.

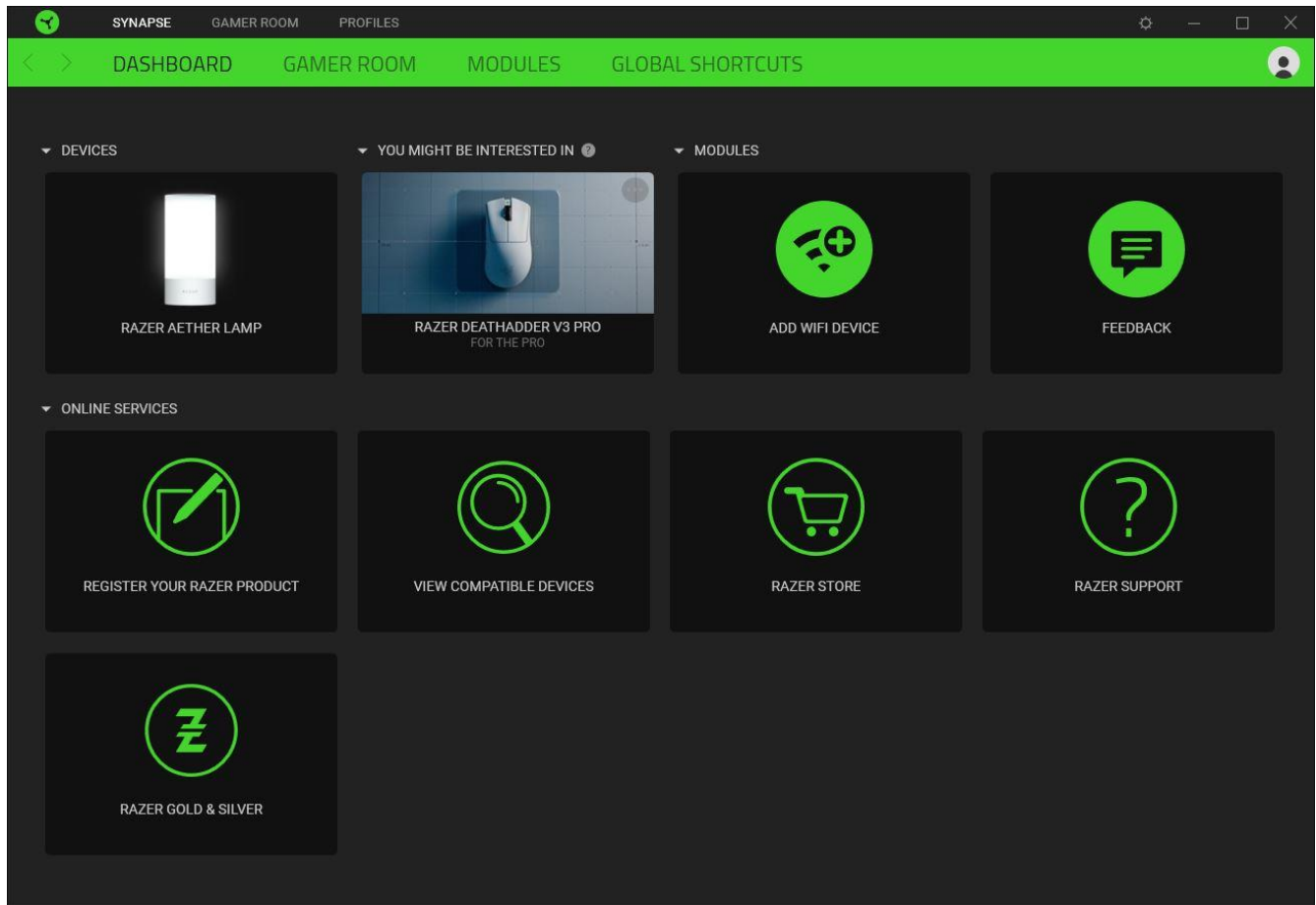

Gamer Room

Use the Gamer Room subtab to manage which devices are directly controlled by Razer Synapse and the Razer Gamer Room app. You can power on or off any Razer Gamer Room device using the Power on/off button () or switch app control by clicking on any device and toggling Synapse Override.

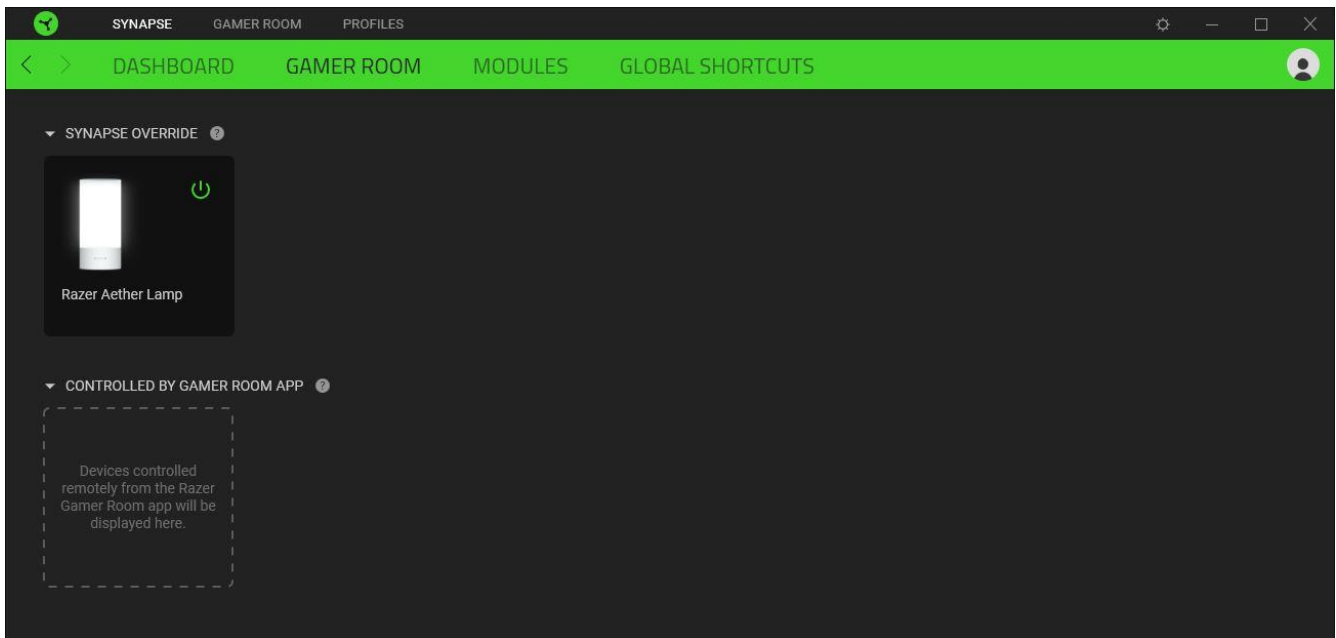

Modules

The Modules subtab displays all installed and available modules for installation.

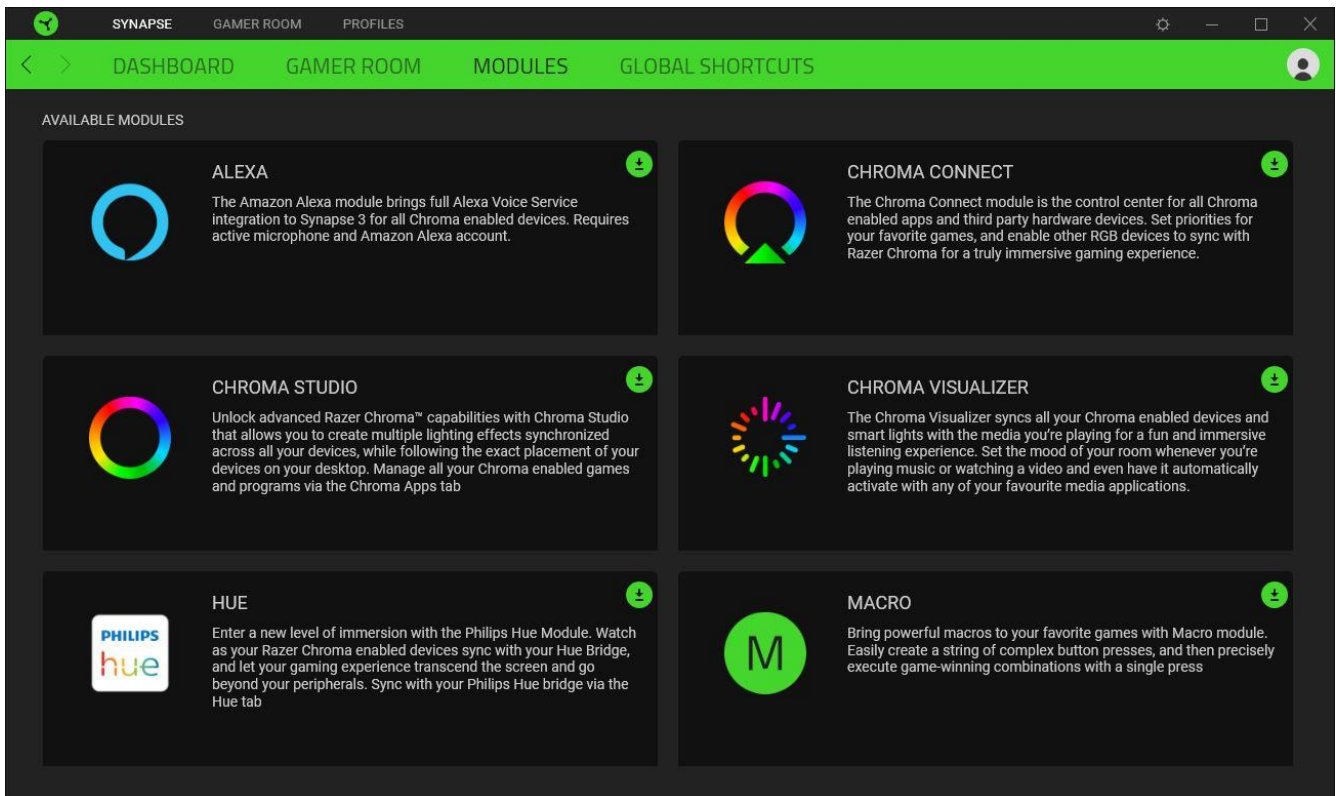

Global Shortcuts

Bind operations or Razer Synapse functions to custom key combinations from Razer Synapse-enabled device inputs that apply across all device profiles. [Learn more about Profiles](#)



Only Razer Synapse-enabled device inputs will be recognized.

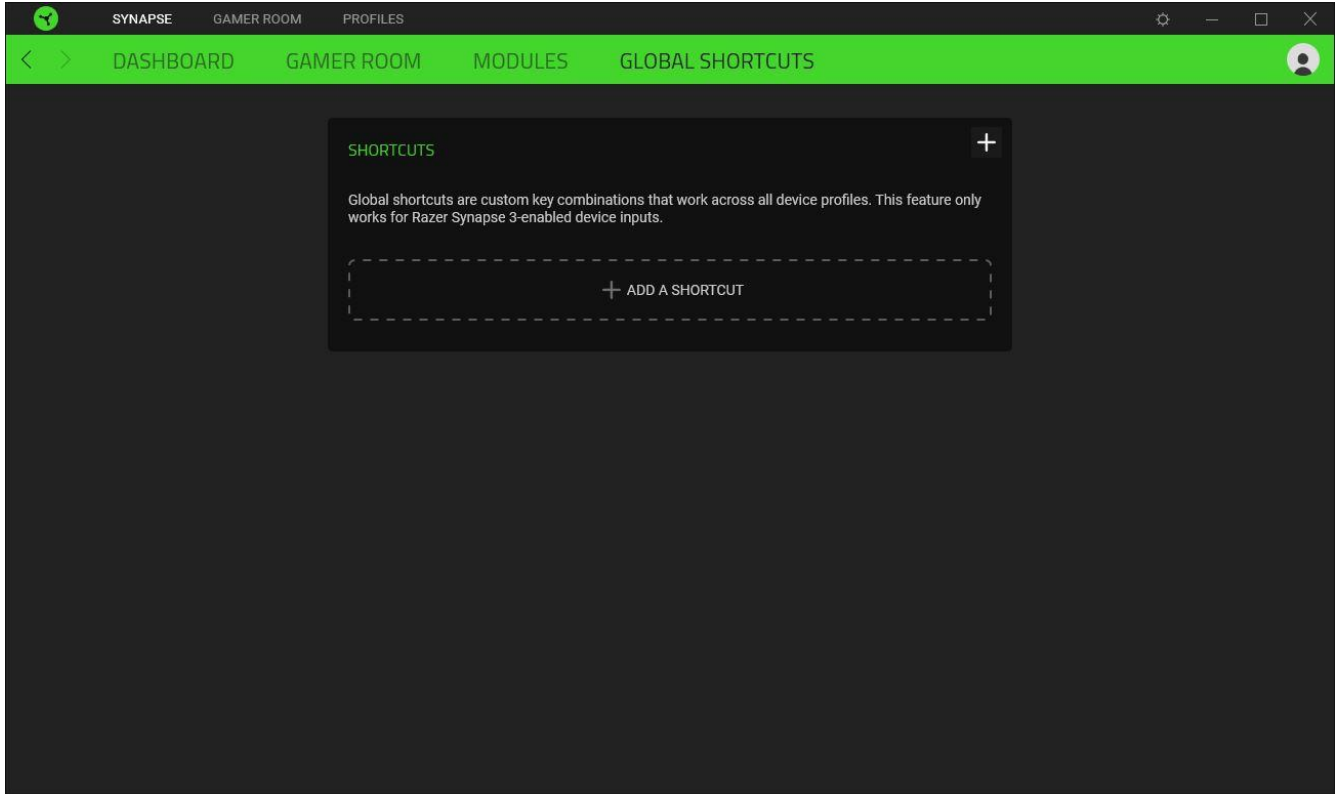

GAMER ROOM TAB

The Gamer Room tab is the main tab for your Razer Aether Lamp. From here, you can customize your device's settings to unleash its full potential. Changes under this tab are automatically saved to your system and cloud storage.

Lighting

The Lighting subtab allows you to manage how Razer Synapse will take control of your device's lighting, adjust the lamp's brightness and customize its lighting effect.

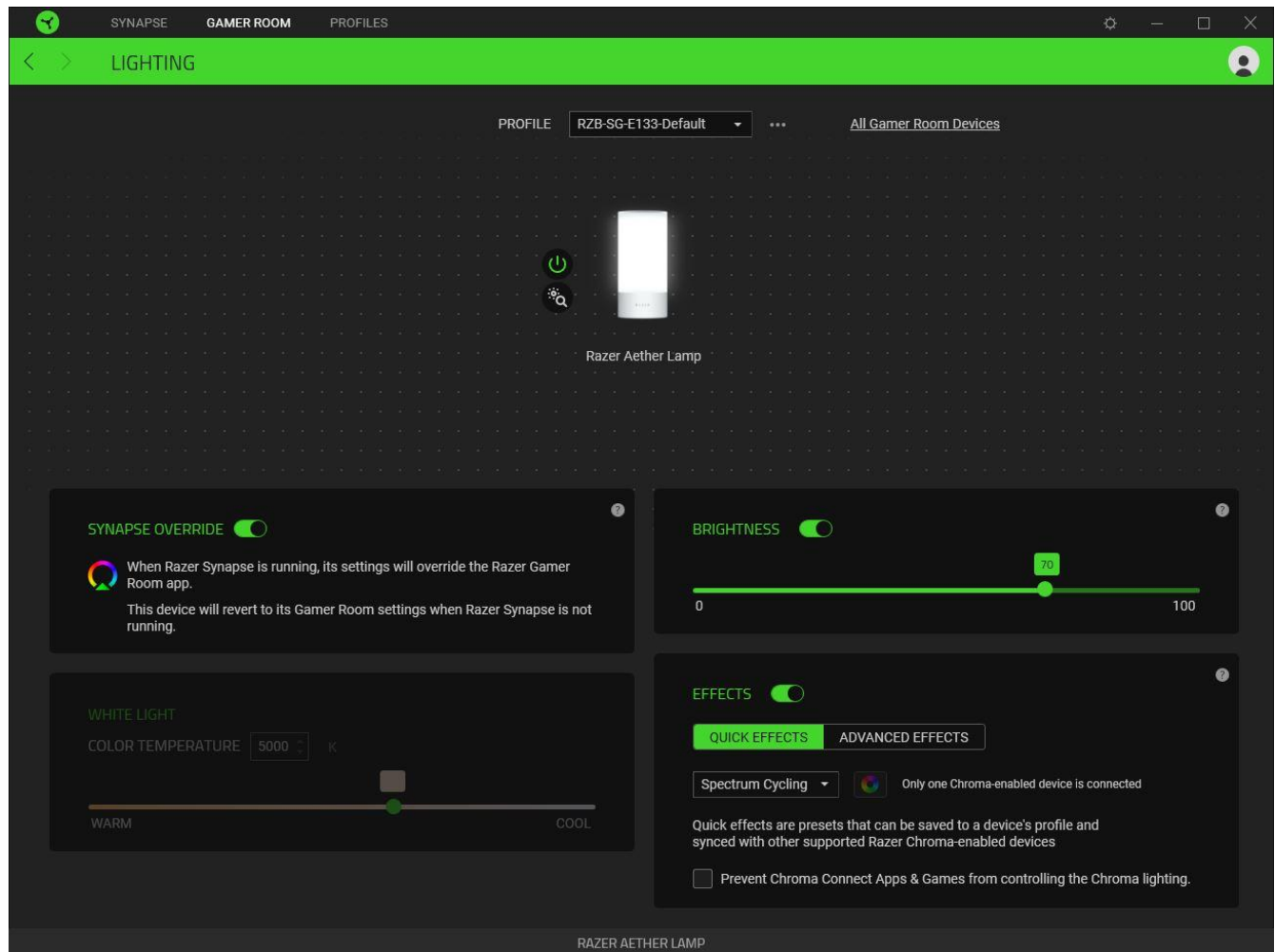

Profile

A Profile is a data storage for keeping all your Razer peripheral's settings. By default, the profile name is based on your system's name. To add, import, rename, duplicate, export, reset or delete a profile, press the Miscellaneous button (●●●).

All Gamer Room Devices

Redirects you to the Synapse > Gamer Room subtab, where you can manage which devices are directly controlled by Razer Synapse and the Razer Gamer Room app.

Power on/off a device

You can turn your Razer device on or off by clicking the Power on/off button ().

Identifying a device

Click the Identify button () to show where your Razer device is in your physical setup.

Renaming a device

Assign your preferred name to your Razer device by clicking on the device name with the Rename cursor ().

Removing a device

Remove a Razer device from your setup by hovering the cursor on its image and clicking the Remove button ().

 *Once removed, you must add the device again on Razer Synapse.*

Synapse Override

Enable this setting to automatically take over and override Razer Gamer Room app settings whenever Razer Synapse is running.

Brightness

Adjust the luminance of your Razer device using the brightness slider, or turn it off entirely by toggling the brightness option.



White light



Adjust how warm or cool the lamp's lighting is.

 *This setting can only be adjusted when Effects is toggled off.*

Quick Effects

Several effects can be selected and applied to the lamp, as listed here:

	Name	Description	How to set up
	Audio meter	The lamp will light up according to the audio level with a default spectrum of colors.	Select a Color Boost level
	Breathing	The lighting will fade in and out of the selected color(s)	Select up to 2 colors or randomize colors

	Spectrum cycling	The lighting will cycle between 16.8 million colors indefinitely	No further customization required
	Static	The lamp will remain lit in the selected color	Select a color

If you have other supported Razer Chroma-enabled devices, you can synchronize their quick effects with your Razer device by clicking the Chroma Sync button (). You can also exclude this device from Chroma Connect Apps & Games by enabling the option provided.

 *Only devices that support the selected lighting effect will synchronize.*

Advanced Effects

The Advanced Effects option allows you to choose a Chroma Effect you want to use on your Razer Chroma-enabled device. To start making your own Chroma Effect, press the Chroma Studio button ().



PROFILES TAB

The Profiles tab is a convenient way to manage all your profiles and link them to your games and applications.

Devices

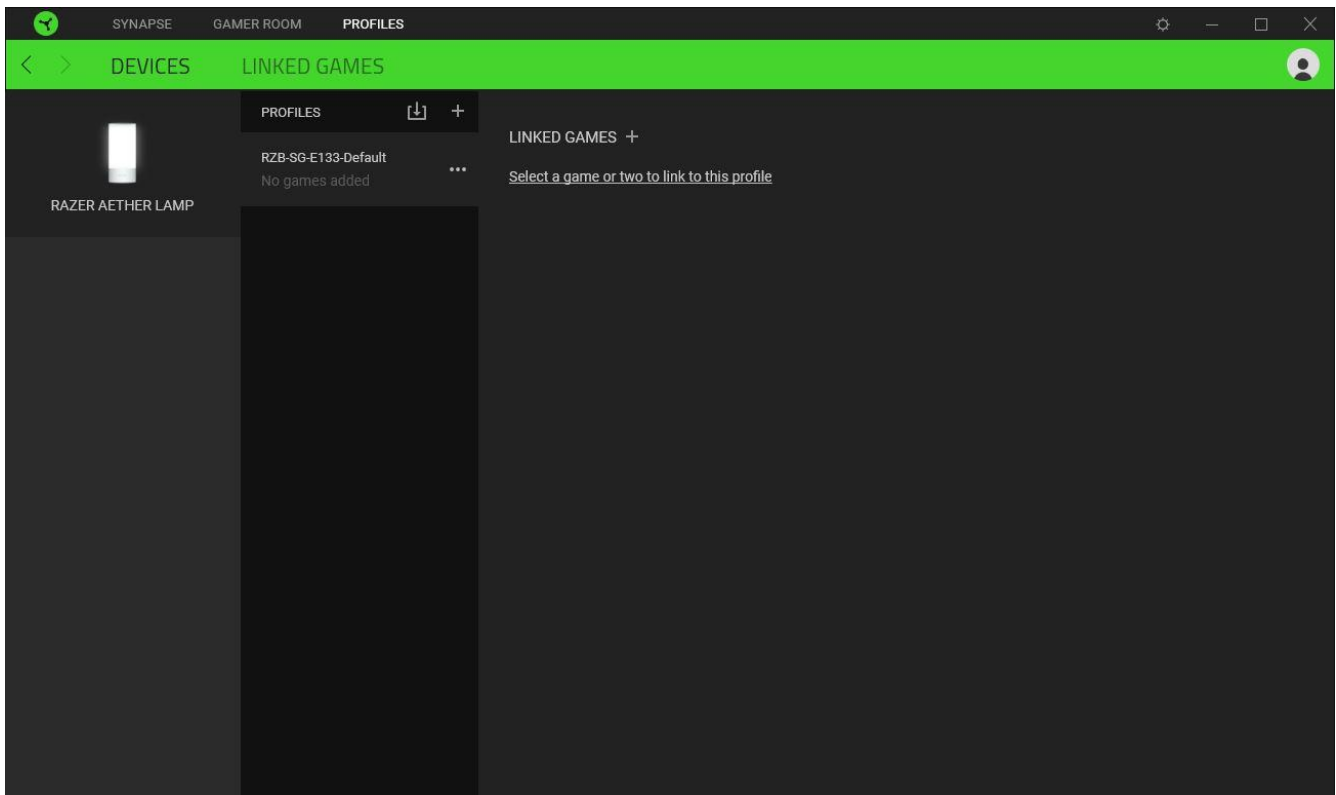
View which games are linked to each device's profiles or which Chroma Effect is linked to specific games using the Devices subtab.



You can import Profiles from your computer or the cloud through the import button () or create new profiles within the selected device using the add button (). To rename, duplicate, export, or delete a profile, simply press the Miscellaneous button (). Each profile can be set to activate when you run an application using the Linked Games option.

Linked Games

The Linked Games subtab allows you to add games, view devices linked to games, or search for added games. You can also sort games based on alphabetical order, last played, or most played. Added games will still be listed here, even if not linked to a Razer device.

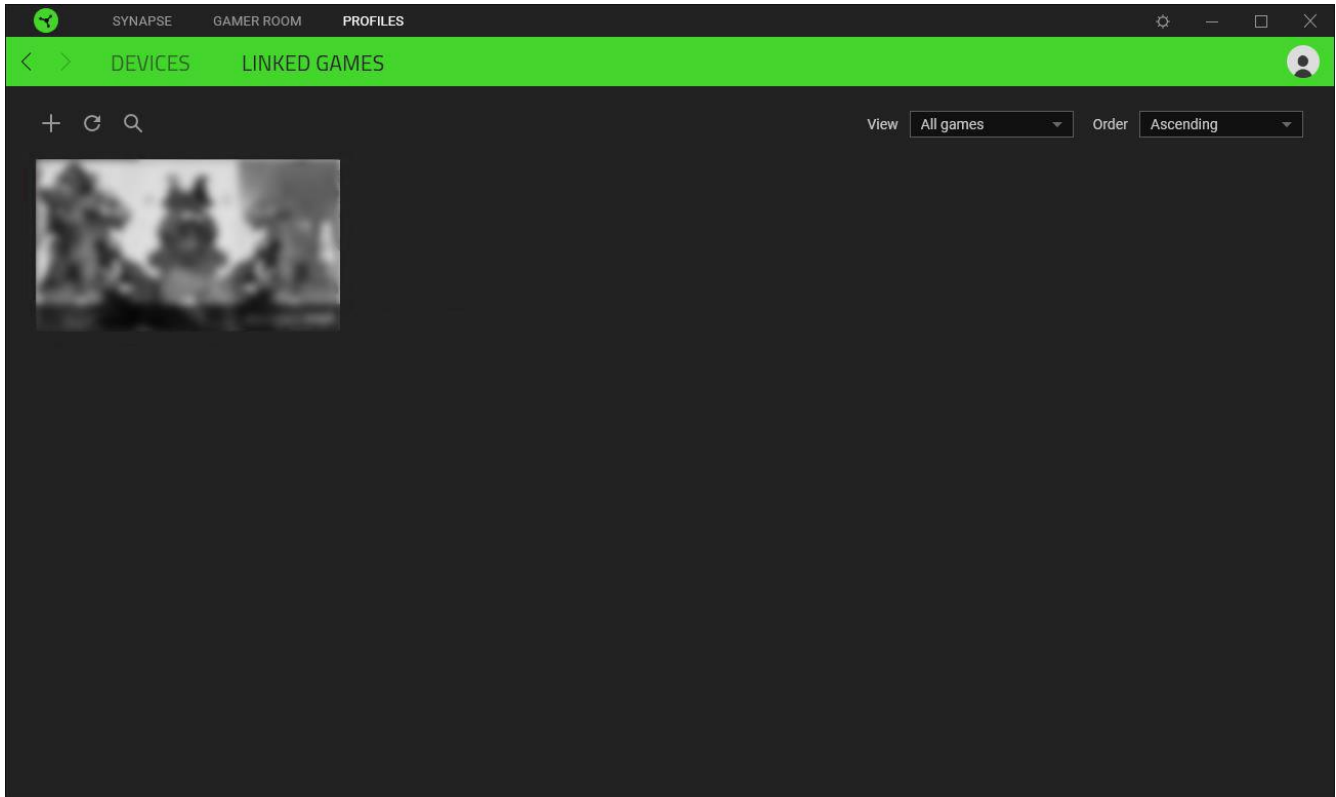

To link games to connected Razer devices or Chroma Effects, simply click on any game from the list, and then click **Select a device and its profile to launch automatically during gameplay** to select the Razer device or Chroma Effect it will link with. Once connected, you may click the Miscellaneous button (●●●) of the corresponding Chroma Effect or device to select a specific Chroma Effect or profile.

SETTINGS WINDOW

The Settings window, accessible by clicking the (⚙) button on Razer Synapse, enables you to configure the startup behavior and display language of Razer Synapse, control the recommendations you see on the Dashboard, check the firmware version and master guide of each Razer device, or perform a factory reset on any connected Razer device.

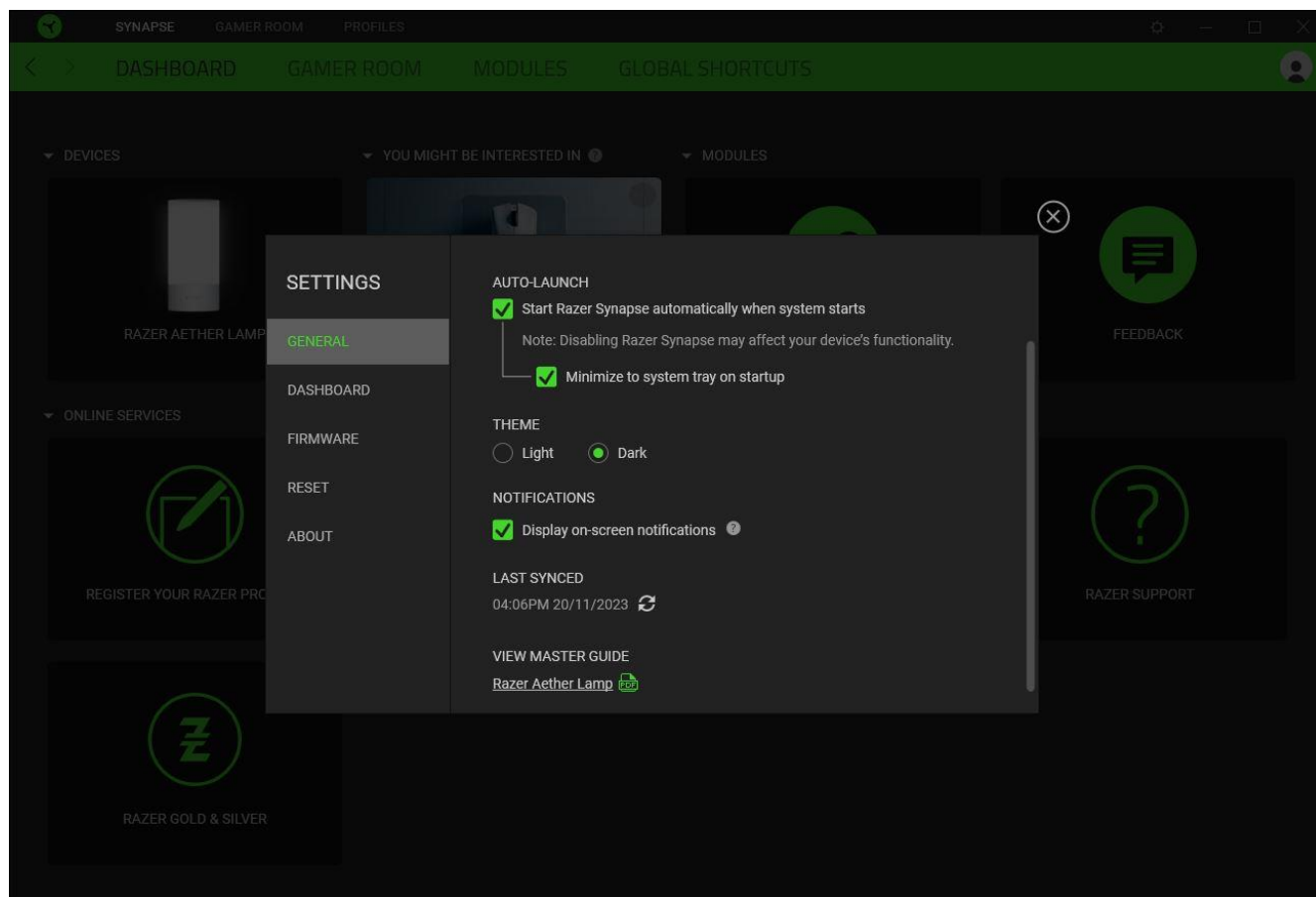

General tab

The General tab lets you change the software's display language, startup behavior, theme, and onscreen notifications. You may also manually sync your profiles to the cloud (↻) or view the master guide of all connected Razer devices and installed modules.

Dashboard tab

Use the Dashboard tab to customize which Razer device recommendations based on your setup, and the games you play will appear on the Dashboard.

Firmware tab

Access the Firmware tab to view the current firmware version of your Razer device(s), and/or visit the Software and Firmware Update page to see whether a firmware update is available for your device(s).

Reset tab

The Reset tab allows you to perform a factory reset on all connected Razer devices with on-board memory and/or reset Razer Synapse tutorials to acquaint yourself again with Razer Synapse's new features on its next launch.



All profiles stored on the selected device's on-board memory will be erased when you reset a Razer device.

About tab

The About tab displays brief software information and copyright statement, and provides relevant links for its terms of use. You may also use this tab to check for software updates, or as quick access to Razer's social communities.

9. SAFETY AND MAINTENANCE

SAFETY GUIDELINES

To achieve maximum safety while using your Razer Aether Lamp, we suggest that you adopt the following guidelines:

- Should you have trouble operating the device properly and troubleshooting does not work, unplug the device and contact the Razer hotline or go to support.razer.com for assistance.
- Don't take apart the device and attempt to operate it under abnormal current loads. Doing so will void your warranty.
- Don't replace the light source of this device. This should only be replaced by the manufacturer, service agent, or a similarly qualified person.
- Only use the device indoors.
- Don't use or install the device near water, moisture, solvents, or other wet surfaces, nor expose it to high temperatures or direct sunlight.
- Keep the device away from liquid, humidity or moisture. Operate the device only within the specific temperature range of 0°C (32°F) to 40°C (104°F). Should the temperature exceed this range, unplug and/or switch off the device to stabilize the temperature to an optimal level.

MAINTENANCE AND USE

The Razer Aether Lamp requires minimum maintenance to keep it in optimum condition. Once a month, we recommend you clean it using a soft cloth to prevent dirt buildup. Don't use soap or harsh cleaning agents.

10. LEGALESE

COPYRIGHT AND INTELLECTUAL PROPERTY INFORMATION

©2024 Razer Inc. All rights reserved. Razer, the triple-headed snake logo, Razer logo, and "For Gamers. By Gamers." are trademarks or registered trademarks of Razer Inc. and/or affiliated companies in the United States or other countries. All other trademarks are the property of their respective owners.

Android, Google, Google Logo, Google Play, and the Google Play logo are trademarks of Google LLC.

Apple, the Apple logo, and iPhone are trademarks of Apple Inc., registered in the U.S. and other countries. App Store is a service mark of Apple Inc. iOS is a trademark or registered trademark of Cisco in the U.S. and other countries and is used under license.

Matter™ is developed by the Connectivity Standards Alliance™. This brand, related logos, and marks are trademarks of the Alliance, all rights reserved.

The Bluetooth® word mark and logos are registered trademarks owned by Bluetooth SIG, Inc., and any use of such marks by Razer is under license.

Windows and the Windows logo are trademarks of the Microsoft group of companies.

Razer Inc. ("Razer") may have copyright, trademarks, trade secrets, patents, patent applications, or other intellectual property rights (whether registered or unregistered) concerning the product in this guide. Furnishing of this guide does not give you a license to any such copyright, trademark, patent or other intellectual property right. The Razer Aether Lamp (the "Product") may differ from pictures whether on packaging or otherwise. Razer assumes no responsibility for such differences or for any errors that may appear. Information contained herein is subject to change without notice.

LIMITED PRODUCT WARRANTY

For the latest and current terms of the Limited Product Warranty, please visit [razer.com/warranty](https://www.razer.com/warranty).

LIMITATION OF LIABILITY

Razer shall in no event be liable for any lost profits, loss of information or data, special, incidental, indirect, punitive or consequential or incidental damages, arising in any way out of distribution of, sale of, resale of, use of, or inability to use the Product. In no event shall Razer's liability exceed the retail purchase price of the Product.

GENERAL

These terms shall be governed by and construed under the laws of the jurisdiction in which the Product was purchased. If any term herein is held to be invalid or unenforceable, then such term (in so far as it is invalid or unenforceable) shall be given no effect and deemed to be excluded without invalidating any of the remaining terms. Razer reserves the right to amend any term at any time without notice.