



RAZER PHONE

MASTER GUIDE

The Razer Phone is equipped with the world's first 120Hz UltraMotion™ smartphone display for the smoothest graphics. Enjoy cinematic audio via front-facing stereo speakers powered by Dolby ATMOS, or THX certified, audiophile-quality music over your headphones. Experience lightning-fast performance with the latest Qualcomm Snapdragon 835 with 8GB of RAM, and best-in-class thermal design. Capture the perfect shot with 12MP dual cameras featuring f1.7 wide angle lens and 2x telephoto lens. Backed by a powerful 4000mAh battery, you have the power to last all day.

CONTENTS

1. PACKAGE CONTENTS	3
2. REGISTRATION / TECHNICAL SUPPORT.....	4
3. TECHNICAL SPECIFICATIONS.....	5
4. DEVICE LAYOUT.....	7
5. SETTING UP YOUR RAZER PHONE	9
6. USING THE RAZER PHONE.....	12
7. CONFIGURING YOUR RAZER PHONE	17
8. SAFETY AND MAINTENANCE	48
9. LEGALESE.....	50

1. PACKAGE CONTENTS

- Razer Phone [64GB]
- Lithium-Ion battery (built-in)
- USB-C charging cable
- USB-C audio adapter
- Quick charger*
- SIM eject pin
- Important Product Information Guide

*May vary for specific regions.

2. REGISTRATION / TECHNICAL SUPPORT

REGISTRATION

Register your product online at razer-id.razer.com/warranty using your Razer ID to get real-time information on your product's warranty status.

If you haven't registered for a Razer ID yet, register now at razer-id.razer.com/ to get a wide range of Razer benefits.

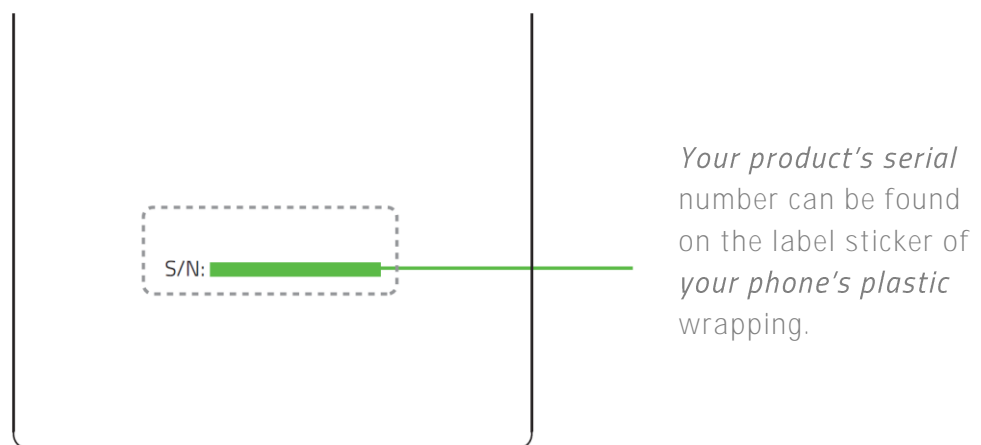

TECHNICAL SUPPORT

What you'll get:

- 1 year limited phone **manufacturer's** warranty*.
- Access to manual, free online technical support, and Razer Support Team assistance at support.razer.com

* Consumer Law. This Limited Warranty gives you specific legal rights, and you may have other rights that vary by your country, province or state, as applicable. Other than as permitted by law, Razer does not exclude, limit or suspend other rights you may have. For a full understanding of your rights, you should consult the laws of your country, province or state, as applicable. For further warranty terms and conditions please visit razer.com/warranty

3. TECHNICAL SPECIFICATIONS

TECHNICAL SPECIFICATIONS

- **Processor:** Qualcomm® Snapdragon™ 835 Mobile Platform
- **System Memory:** 8GB dual channel (LPDDR4, 1866MHz)
- **Storage:**
 - Internal: 64GB UFS
 - External: microSD (class 10, 2TB max.)
- **Display:**
 - 5.7-inch IGZO LCD (1440x2560)
 - 120 Hz, Wide Color Gamut (WCG)
 - Corning Gorilla Glass 3
- **Rear Cameras :**
 - 12MP AF f1.75 Wide
 - 12MP AF f2.6 Zoom
 - Dual PDAF
 - Dual tone, dual LED flash
- **Front Camera:** 8MP FF f2.0
- **Sound**
 - Stereo Front-facing speakers
 - Dual Amplifiers
 - Audio Adapter with THX certified DAC
- **Power**
 - 4000mAh lithium-ion battery
 - Qualcomm QuickCharge 4.0+
- **Wireless:**
 - 802.11 a/b/g/n/ac
 - Bluetooth 4.2
 - NFC
- **Bands**
 - GSM: Quad-band GSM
 - UMTS: B1/2/3/4/5/8
 - LTE: B1/2/3/4/5/7/8/12/17/19/20/25/26/28/29/30/66
 - TDD LTE: B38/39/40/41 TD-SCDMA: B34/39

APPROXIMATE SIZE & WEIGHT

- Length: 158.5 mm / 6.24 in
- Width: 77.7 mm / 3.06 in
- Height: 8 mm / 0.31 in
- Weight: 197 g / 0.43 lbs

4. DEVICE LAYOUT

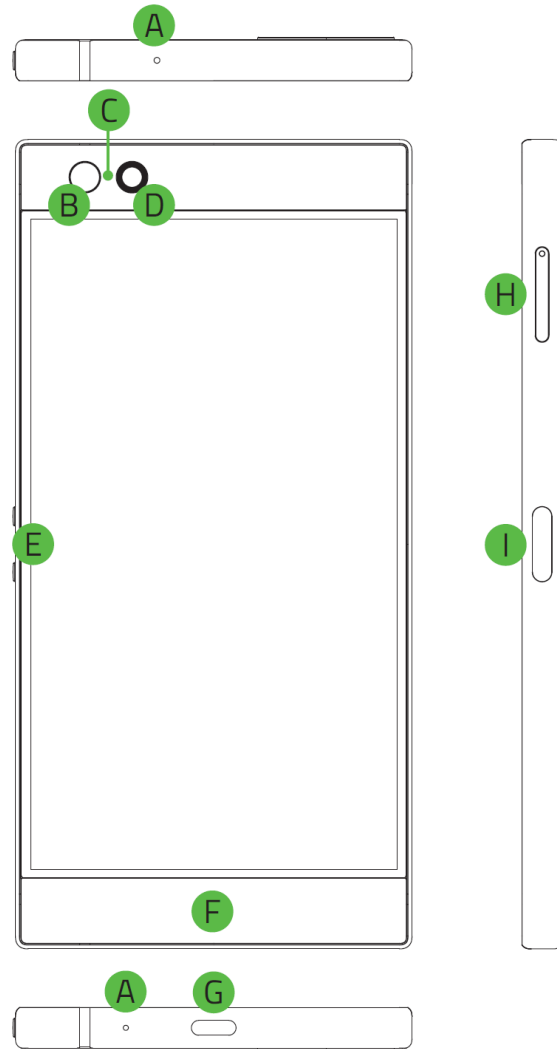

- A. Microphones
- B. Ambient light sensor
- C. LED indicator
- D. Front camera
- E. Volume control buttons
- F. Speakers
- G. USB-C port
- H. MicroSD / SIM card tray
- I. Power button / Fingerprint sensor

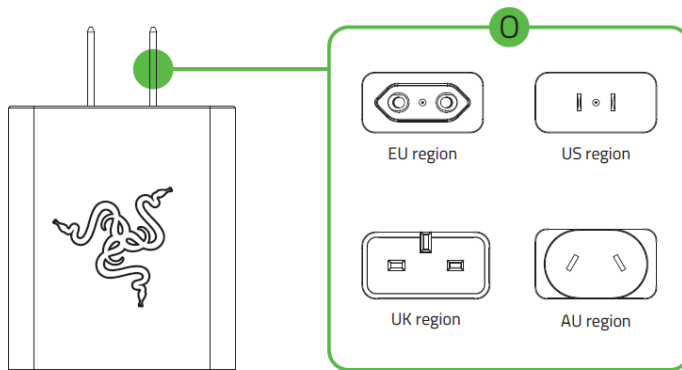
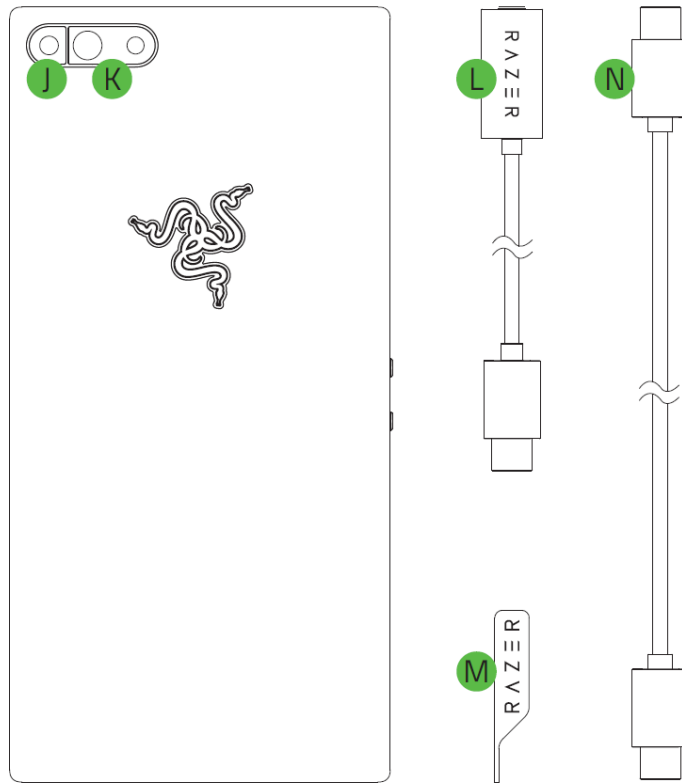

- J. Flash
- K. Dual rear camera lens
- L. USB-C audio adapter
- M. SIM eject pin
- N. USB-C charging cable
- O. Quick charge

5. SETTING UP YOUR RAZER PHONE

INSTALLING A SIM CARD / MICROSD CARD

1. Insert the sim eject pin into the sim tray hole then push it in to eject and remove the sim tray.

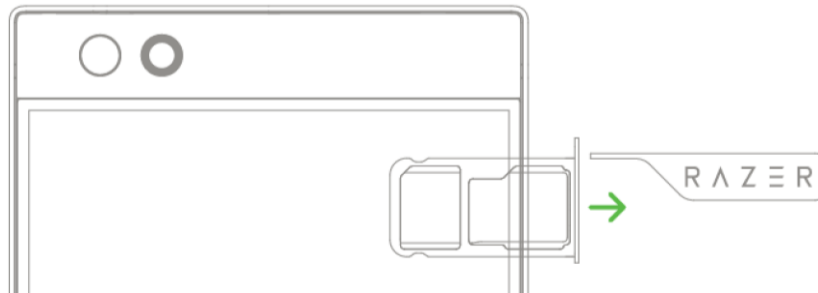

2. Place your sim card* into the sim tray correctly. You may also place a micro SD card* into the sim tray if you want additional storage space for your phone.

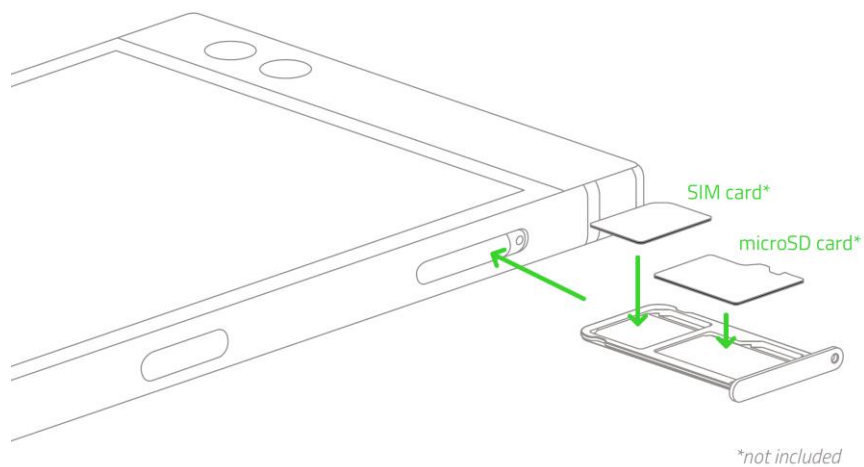

3. Reinsert the sim tray into your phone and gently push it in until it fits into place.

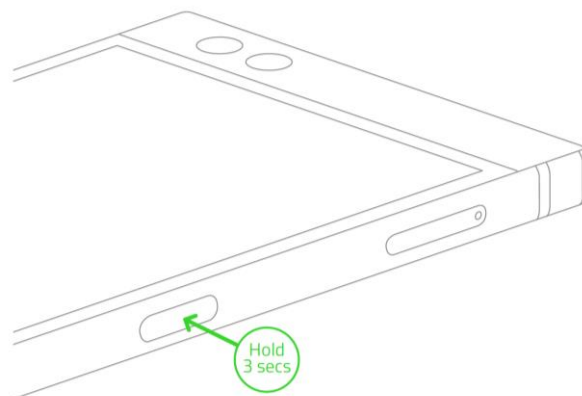

CHARGING YOUR RAZER PHONE USING THE QUICK CHARGER

1. Connect the Quick charger to your Razer Phone using the USB-C charging cable, then plug it to a power outlet.

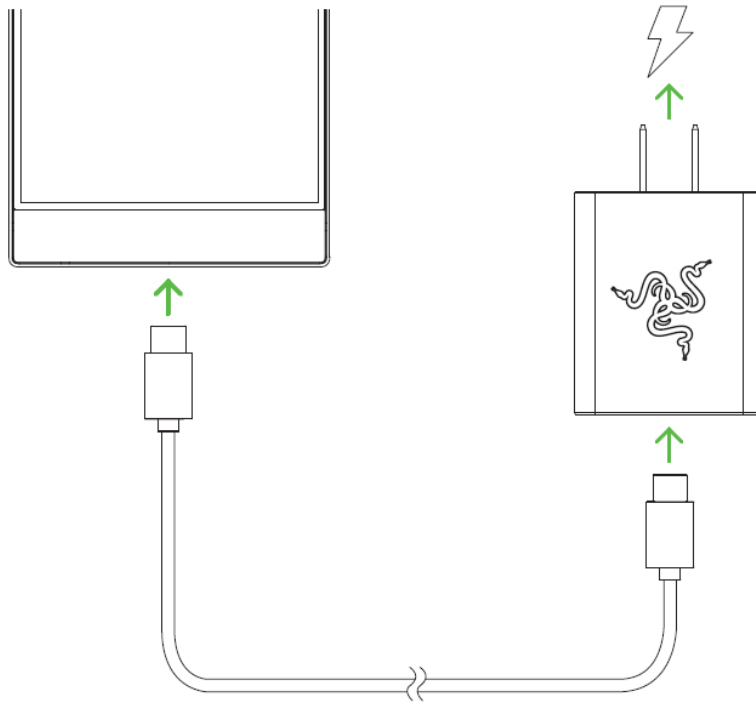

Note: To efficiently charge your phone, please use the Quick charger provided in the package. In addition, only use and/or purchase accessories made and/or approved by Razer.

2. Wait for your Razer Phone to fully charge, and then detach the USB-C connector from your phone.

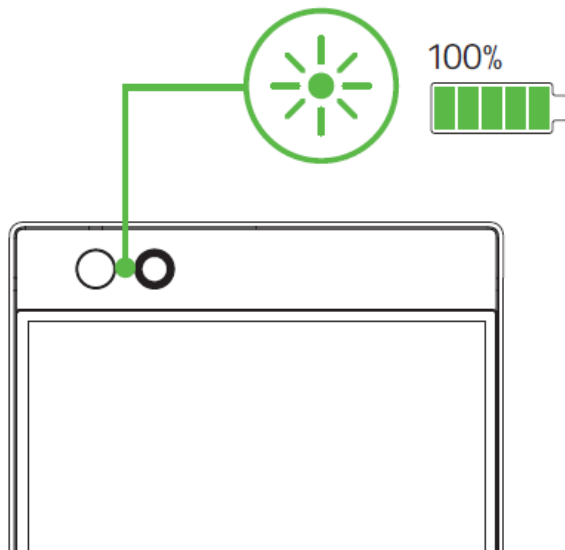

Note: When powered off, you may view the charging level of your phone by pressing the power key.

If powered on, the battery charging level can be viewed on the upper right corner of the screen.

3. Unplug the Quick charger from the power outlet.

POWERING IT ON / OFF

To power on your phone, press and hold the power key until your Razer Phone powers on.

To power it off, press and hold the power key until the Power actions menu shows onscreen, then tap Power off to turn off your device.

SETTING UP FOR FIRST USE

On its first use, the Razer Phone will prompt you a Welcome screen which allows you to proceed with the setup wizard and/or even customize **your phone's** basic vision accessibility settings.

Follow the onscreen instructions from choosing **your phone's default language, accepting Razer's Terms and Conditions**, selecting whether your phone will connect to a wireless or data network, copying data from a mobile device or setting it up as a new device, personalize phone settings and services, and even setting up accounts.

Note: These settings can also be customized later through *your phone's* Settings.

6. USING THE RAZER PHONE

DEFAULT PHONE BUTTON FUNCTIONS

- Power Key
 - Press to lock / unlock the phone.
 - Double press to launch the camera app from any screen.
 - Press and hold to open the Power actions menu.
- Volume keys
 - Increase or decrease ring, media, and alarm sounds.
 - Press any of these from the camera app to take a photo.
- Power Key + Low volume key
 - Press both keys simultaneously to take a screenshot.

TOUCHSCREEN NAVIGATION GESTURES

- Tap. Lightly tap to select an option, launch a chosen app, or to enter text using the virtual keyboard.
- Double Tap. Lightly tap twice on an image to zoom in or out on a selected area or text to select a word.
- Tap and Hold. Tap and hold an item or app to open additional options for the selected item.
- Tap and Drag. Tap and hold an item or app, and then move your finger to drag it to the preferred location.
- Swipe. Lightly tap and move your finger horizontally or vertically across the screen. Use this gesture to move through lists, scroll through webpages, browse photos, and perform other browsing functions.
- Pinch and Spread. Pinch or spread two fingers to zoom out or in on an image or on other kinds of content such as a map or webpage respectively.

LOCKING / UNLOCKING THE SCREEN

To lock the screen, simply press the power key and the screen will turn off indicating that the screen is now locked. To unlock, simply press the power key, and then swipe up.

Note: If you have already customized your lock screen's security setting, you may need to use the screen lock setting set of your phone. [Click here to know more about Screen Lock](#)

THE LOCK SCREEN AND DESKTOP

Lock screen

Desktop

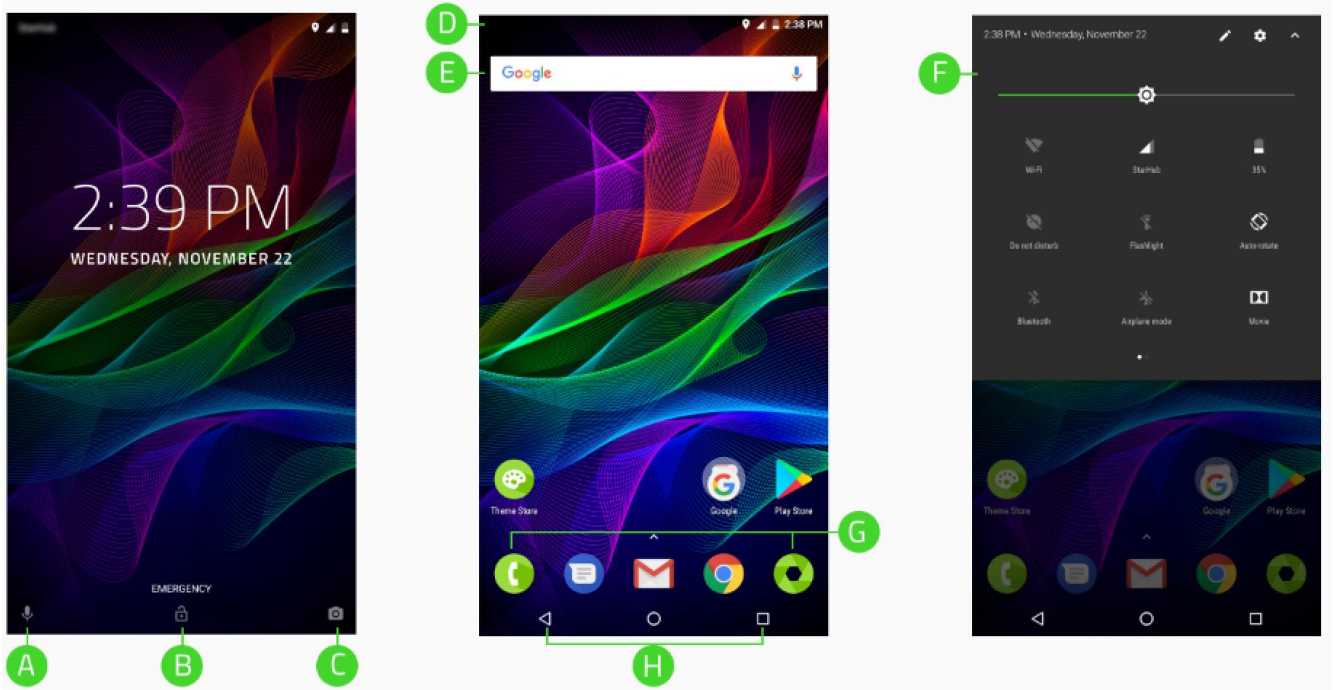



















- A. Google Voice Input
- B. Unlock screen
- C. Camera
- D. Status bar
- E. Google Search widget
- F. Notifications pane
- G. Dock
- H. Desktop navigation

Lock screen

- Voice input. Swipe this icon upwards to activate Google Voice for hands-free accessibility.
- Emergency. Call anyone without unlocking the screen in case of an emergency.
- Camera. Swipe this icon upwards to open the camera app without unlocking the screen.



Desktop

- Google Assistant. From the Desktop simply swipe right to open the Google Assistant. [Click here to know more about Google Assistant](#)
- Status bar. Displays quick information such as alerts and notifications.

	Battery status*		Connected to a Wi-Fi network
	Battery charging		4G+ *
	Do not disturb		Bluetooth is active
	Do not disturb (Total silence)		Connected to a Bluetooth device
	Vibrate		Network signal
	MicroSD card detected		No signal
	No SIM card		Location active
	Missed call		Aeroplane mode
	Available Wi-Fi networks		New message









*May vary according to status, location and/or the app being used.

- Google Search widget. Allows you to have immediate access to Google Search using either voice or key input.
- Notifications pane. Provides quick accessibility to essential phone settings. To open the notifications pane, simply drag the status bar downwards. You can expand the pane by tapping  or swiping downwards again to view all accessible settings.

You may also add or remove the notifications icon displayed through the Edit icon (), or **access the phone's** settings through the Settings icon ().







By default, the following icons can be seen on the notifications pane:

Icon	Notification	Description
	Wireless	<ul style="list-style-type: none"> ▪ Displays the wireless network the phone is connected. ▪ Tap to show other wireless networks within range.

		<ul style="list-style-type: none"> Press and hold to open Wi-Fi settings. Click here to know more about Wireless
	Cellular Data	<ul style="list-style-type: none"> Shows the SIM card's service provider name. Tap to access your phone's Data usage settings. Click here to know more about Data usage
	Battery status	<ul style="list-style-type: none"> Displays the battery percentage. Tap to display the Batter usage chart and/or access the Battery Saver toggle. Press and hold to open Battery settings. Click here to know more about the Battery settings
	Do not disturb	<ul style="list-style-type: none"> Shows the Do not disturb option mode being used. Tap to display and change the Do not disturb options available. Press and hold to open the Do not disturb settings. Click here to know more about Do not disturb
	Flashlight	Tap to toggle the flashlight on or off.
	Auto-rotate	<ul style="list-style-type: none"> Toggle your phone screen's orientation between Auto-rotate and Portrait mode. Press and hold to access the Display settings. Click here to know more about Display
	Bluetooth	<ul style="list-style-type: none"> Tap enable Bluetooth and to see all devices you have paired with your phone via Bluetooth. Press and hold to view all available Bluetooth devices within range. Click here to know more about Bluetooth
	Aeroplane Mode	<ul style="list-style-type: none"> Tap to toggle Aeroplane mode on or off. Press and hold to access the Wireless & networks settings. Click here to know more about other wireless settings
	Dolby Atmos [®]	<ul style="list-style-type: none"> Tap to select and enable a Dolby Atmos setup. Press and hold to open the Dolby Atmos app. Click here to know more about Dolby Atmos

	Night Light	<ul style="list-style-type: none"> ▪ Tap to toggle Night Light on or off. ▪ Press and hold to open the Night Light settings. <p>Click here to know more about Night light</p>
---	-------------	---

Other icons which you may add to the notifications pane are as follows:

Icon	Notification	Description
	Invert colors	<ul style="list-style-type: none"> ▪ Tap to toggle between normal and inverted color mode. ▪ Press and hold to open Accessibility settings. <p>Click here to know more about Accessibility</p>
	Hotspot	<ul style="list-style-type: none"> ▪ Tap to toggle the Hotspot function on or off. ▪ Press and hold to open the Tethering & portable hotspot settings. <p>Click here to know more about Hotspot</p>
	Location	<ul style="list-style-type: none"> ▪ Tap to toggle the Location function on or off. ▪ Press and hold to open the Location settings. <p>Click here to know more about Location</p>
	Data Saver	<ul style="list-style-type: none"> ▪ Tap to toggle the Data Saver function on or off. This will prevent the apps you have identified to send and/or receive data in background while enabled. ▪ Tap to access your phone's Data usage settings. <p>Click here to know more about Data usage</p>
	Google Nearby	<p>Tap to access the Google Nearby app.</p> <p>Click here to know more about Google Nearby</p>
	Cast	<p>Tap to cast your phone's screen on compatible device.</p>

- Desktop navigation. Primary navigation across all apps.
 - ◀ Return. Return to the previously opened screen or hide active windows.
 - ○ Desktop. Tap to go back to Desktop. Tap and hold this button to open Google Assistant.

- Used apps. Display all recently opened applications. You may close all opened applications by tapping on CLEAR ALL or open applications in Split view by tapping on an app in the list and dragging it upwards.
- Dock. Use this to have immediate accessibility over the applications you commonly use.
- Applications Drawer. Display all applications installed on your phone. To access the Applications menu, from the Dock, simply swipe upwards.

ENTERING CHARACTERS OR TEXT

The QWERTY keyboard will automatically open whenever tapping on an input field. You may also tap any of the keys below to use their special functions:

- Google Search. Search and share browsing links.
- Voice input. Enter text using Google Voice.
- Symbol. Insert symbols and/or other special characters.
- Emoticon. Insert emoticons. Allows you to select any of the following:
 - Enable one-handed keyboard operation.
 - Show number keys while hiding the predictive text options on the keyboard.
 - Inserts the cursor to the next line.
- Resume text typing. Tap this button to resume typing text when you have previously entered Symbol / Emoticon entry.

7. CONFIGURING YOUR RAZER PHONE

CUSTOMIZING THE DESKTOP

Adding / Removing app shortcuts

To add new application icons to the Desktop, simply tap and hold on any app on the application drawer until the Desktop displays, then drag the app icon to the preferred desktop area.

To remove an application shortcut, long press on an icon and tap Remove.

Adding / Removing Desktop pages

Press and hold the Desktop page that you want to remove. The Desktop pages would appear, allowing you to add in other Desktop pages through the  icon found on the right most desktop page.

Alternatively, you may also long press on any Desktop shortcut, and drag it to the right most part of the desktop pages to create a new Desktop page.

To remove a desktop page, long press on any desktop page and drag it to the Delete icon ().

Using widgets

Widgets are smaller versions of the applications you commonly use on your phone which you can add in to your Desktop for quick function accessibility.

To add a widget on the Desktop screen, press and hold on the desktop screen and then tap the Widgets icon (). You may then press and hold again on the widget that you want to add, and then drag it to the desired location.

Grouping app shortcuts

To group multiple app shortcuts in a single folder on the Desktop, tap and drag the app shortcut to the app shortcut you want to group it with.

CUSTOMIZING THE SETTINGS

Accessible from the Applications drawer, Settings enable you to customize and control your **phone's overall properties.**

Note: The Settings menu is constantly accessible throughout the Settings app through its Sidebar  . You may access the Sidebar by simply swiping right from leftmost side of the screen while inside Settings.

Wireless & networks

Manage and configure various network and connectivity settings

Wi-Fi

Connect your phone to a wireless network within the area.

Connecting to a wireless network

To connect your phone to a wireless network:

1. From the Desktop, swipe upwards to show the Applications drawer, then tap Settings > Wi-Fi.
2. Toggle Wi-Fi on. The phone will automatically start scanning for wireless networks within the area. To refresh the list, simply tap , and then tap Refresh.

Note: You may also access the Wi-Fi settings page through the Notifications pane. Tap and hold the Wi-Fi icon from the Notifications pane to have your phone scanning for available wireless networks.

3. Tap the wireless network you want to connect to then enter the required password (if any).

Note: Once connected, your phone would automatically connect to the wireless network *whenever the phone's Wi-Fi* is on and the wireless network is within reach.

Manually connecting to a wireless network

If you want to manually connect your phone to a hidden wireless network:

1. From the Desktop, swipe upwards to show the Applications drawer, then tap Settings > Wi-Fi.
2. Toggle Wi-Fi on.
3. At the bottom of the scanned wireless networks list, tap + Add network, and then enter the required details needed.

Connecting to a wireless network using the WPS

Wi-Fi Protected Setup (WPS) allows you to connect to a WPS-enabled device with a push of a button. You may use the WPS Push Button feature of your phone to connect to your WPS-enabled router:

1. On your wireless router, press the WPS button, this will initiate the WPS setup.

Note: You may have to refer to the user manual of your wireless router in using its WPS feature.

2. On your phone, from the Wi-Fi settings, tap , and then tap Advanced > WPS Push button. Your phone will automatically connect with the WPS-enabled router.

Note: Please make sure to complete the setup within two minutes. Otherwise, you may have to restart the pairing process again.

Alternatively, you may also use the WPS Pin Entry feature of your phone to connect it to a wireless router.

1. On your phone, from the Wi-Fi settings, tap , then tap Advanced > WPS Pin Entry.
2. **On your wireless router's interface, enter the WPS pin** provided by your phone. Your phone will automatically connect with the WPS-enabled router.

Note: You may have to refer to the user manual of your wireless router in using its WPS feature.

Using Wi-Fi Direct

Connect your phone directly to a Wi-Fi direct capable device through wireless connectivity. Use this feature to share contacts and files to other devices.

Connecting / Disconnecting a device

1. On your phone, from the Wi-Fi settings, tap , then tap Advanced > Wi-Fi Direct.
2. Select the device that you want to connect to on the list to send a Wi-Fi Direct invite.
3. Confirm the invite on the other device. Your device is now connected to your phone through Wi-Fi direct.

Note: To disconnect a device, tap the connected device from the list and then confirm.

Wi-Fi Settings

1. From the Desktop, swipe upwards to show the Applications drawer, then tap Settings > Wi-Fi.
2. Tap the Configure Wi-Fi settings button () to change or view the following wireless properties listed below:
 - Saved networks. Display all wireless networks saved in your phone. Tapping on any saved wireless network will allow you to view the provided security of the selected network as well as remove it from the list through the FORGET button.
 - Network notification. Toggle public wireless network availability on or off.
 - Keep Wi-Fi on during sleep. Select **the behavior of the phone's** Wi-Fi during sleep.
 1. Always. During sleep, the Wi-Fi is always on.
 2. Only when plugged in. Wi-Fi is only enabled during sleep when charging.

3. Never. Wi-Fi is off when the phone is in sleep mode.
- Phone properties. Display the MAC address and IP address of your phone.

Bluetooth

Securely pair your phone with a Bluetooth device.

Configuring the Bluetooth settings

Securely pair your phone with a Bluetooth device.

1. From the Desktop, swipe up to show the Applications drawer, then tap Settings > Bluetooth.
2. Tap  to do any of the following:
 - Refresh. Refresh the Bluetooth devices scanned within the area.
 - Rename. Rename the **phone's** displayed name as a Bluetooth device.
 - Show received files. Open the Bluetooth folder of all the files transferred to your phone.

Pairing your phone with a Bluetooth device

To pair your phone with a Bluetooth-enabled device:

1. Enable the Bluetooth device that you want to pair with your phone.

Note: Remember the Bluetooth name of the device you want to pair with your phone, and make sure that the device is discoverable / visible for other Bluetooth devices.
2. From the Desktop, swipe up to show the Applications drawer, then tap Settings > Bluetooth.

Note: You may also access the Bluetooth settings page through the Notifications pane. Tap and hold the Bluetooth icon from the Notifications pane to *open your phone's Bluetooth settings*.
3. On the Bluetooth devices list, tap the device that you want to pair with your phone and confirm that you want to pair your phone with the device.

Note: You may also provide permission for the device to access your contacts and call history if you want to use the Bluetooth device for phone calls or if you want to share contacts. Some devices may provide a passkey or Bluetooth pairing code which you may have to confirm on both devices.
4. The device will automatically pair and be added to the Paired devices list.

Note: If *the device you paired with is within reach and discoverable, and your phone's Bluetooth is enabled*, your devices would automatically pair with each other and/or will be readily accessible.

Changing Bluetooth device permissions

Once you have paired a Bluetooth device with your phone, you may change the usage permissions of the paired device.

1. On the Bluetooth > Paired devices list, tap the corresponding  icon of the device that you want to have the usage permissions changed.
2. Tap any of the usages that you want the paired device to be used for. Do take note that the usages listed below may vary for each device:
 - Phone audio. Use the connected Bluetooth device for phone calls.
 - Media audio. Use the connected Bluetooth device.
 - Contact sharing. Share phone contacts with the Bluetooth device.

Disconnecting a Bluetooth device

To disconnect a Bluetooth device from your phone:

1. On the Bluetooth > Paired devices list, tap the connected Bluetooth device that you want to disconnect from your phone.
2. Tap OK on the Disconnect prompt to confirm. The device will disconnect from your phone.

Forgetting a Bluetooth device

To remove a Bluetooth device from the paired devices list:

1. On the Bluetooth > Paired devices list, tap the corresponding  icon of the device that you want to unpair with your phone.
2. Tap Forget to remove the device from the list.

Note: You would need to pair your phone again with Bluetooth device if you want to connect your devices again.

Data Usage

Monitor and set data usage restrictions across all applications, as well as set necessary notifications or warnings when your preferred data limit has been reached.

Enabling cellular data

1. From the Desktop, swipe up to show the Applications drawer, then tap Settings > Data usage > Cellular data usage.
2. Tap Cellular data to toggle the cellular data on.

Note: You may also use the notifications pane to enable your phone's cellular data.

Checking an app's data usage

To see or monitor how much data an app is using:

1. From the Desktop, swipe up to show the Applications drawer, then tap Settings > Data usage > Cellular data usage.
2. Check the list for the app that you want to monitor. An overview of how much data each app is using can be seen, while in-depth usage can be seen if you tap an app.

Using the Data saver

Reduce overall data usage by preventing the apps you have set to sending and/or receiving data in background.

1. From the Desktop, swipe up to show the Applications drawer, then tap Settings > Data usage.
2. Tap Data saver and toggle it on.
3. Tap Unrestricted data access, and toggle on the applications which you want to have restricted data access.

Note: You may also include system apps on the list by simply tapping on , and then tapping on Show system.

Customizing the Data usage warning

You may customize **the data usage warning according to your plan's billing cycle**. From the Desktop, swipe up to show the Applications drawer, then tap Settings > Data usage > Billing cycle. Listed below are the properties you can customize:

- Billing cycle. Sets the specific month date wherein the data usage counter will reset.

- Set data warning. Toggle the data warning on or off. Enabling the data warning will allow you to set how much data to be consumed before the data warning usage appears.
- Data warning. Set the amount of data needed for the data warning to trigger.
- Set data limit. Automatically turn off cellular data once it reaches the set amount of data.
- Data limit. Set the amount of data needed for the data limit to trigger.

Other wireless & networks settings

Configure your phone's other wireless and connectivity settings.

1. From the Desktop, swipe up to show the Applications drawer, then tap Settings > More. The settings you can configure are as listed below:

- Aeroplane mode. Disable all connectivity functions on your phone such as Wi-Fi, network data, and Bluetooth.
- NFC. Enable NFC (Near Field Communication) which enables you to exchange data with other NFC capable devices upon contact.
- Wi-Fi calling. Route calls via Wi-Fi or carrier network depending on your preference or which is stronger.

Note: Please check with your network carrier regarding fees which may apply.

- Android Beam. Beam app content such as browser pages, videos, contacts etc. to another NFC-capable device by holding your phone close together with the device.
- Tethering & portable hotspot. Utilize the tethering and wireless hotspot options of your phone as listed below:

- USB Tethering. **Share your phone's** internet connection to a connected USB device.
- Portable Wi-Fi hotspot. **Share your phone's** internet connection by making your phone into a Wi-Fi hotspot devices can connect to.

Note: This may significantly affect overall battery usage.

- Set up Wi-Fi hotspot. Change the Wi-Fi hotspot properties of your phone as listed below:
 - Network name. The name of the Wi-Fi hotspot
 - Security. Encryption used by the network.
 - Password. The Wi-Fi hotspot's security key.
 - AP Band. The frequency band used by the Wi-Fi hotspot.

- Bluetooth tethering. **Shares your phone's internet connection to a Bluetooth enabled device it is paired with.**
- VPN. Set up, connect, and/or manage your own VPNs (Virtual Private Networks).
Note: A lock screen pin or password is required before you can use this feature.

To add a VPN profile:

1. From the Desktop, swipe up to show the Applications drawer, then tap Settings > More > VPN.
2. Tap the Add + button, and then correctly enter the needed details on the Edit VPN profile fields provided. The new profile will be added into the VPN list.

To edit a VPN profile:

1. From the Desktop, swipe up to show the Applications drawer, then tap Settings > More > VPN.
2. Tap the corresponding settings icon () of the VPN profile that you want to edit, and then change the fields needed.
3. Tap Save to apply the changes, or Forget to delete the VPN profile.

To connect or disconnect from a VPN profile

1. From the Desktop, swipe up to show the Applications drawer, then tap Settings > More > VPN.
2. Tap the VPN profile you want to connect to and then enter the needed details.
3. Tap Connect.

Note: To disconnect from the VPN, tap the active VPN profile and then tap Disconnect.

- Mobile networks. **Manage your phone's data service.**
 - Data roaming. Toggle data roaming on or off when your device is on a different network.
 - Preferred network type. Choose a specific mobile network type your phone would use.
 - Enhanced 4G LTE Mode. Toggle the usage of 4G LTE mode on or off to improve voice and other communications.
 - Access Point Names. Select or add APNs.
 - Network operators. View available network operators.

- Network settings reset. Resets all changes made on the network settings such as Wi-Fi, cellular data, and Bluetooth.

Device

Manage or customize various display, sound, and notification settings. You may also configure or manage other hardware settings such as storage, memory, and gestures.

Display

Modify your phone's display settings such as its brightness options, refresh rate, and other related settings.

Brightness level and Adaptive brightness

Change the brightness level or optimize the brightness for available light.

1. From the Desktop, swipe up to show the Applications drawer, then tap Settings > Display.
2. Tap the Brightness level to display the luminance slider and increase or decrease the screen brightness as preferred.

Note: You may also use the Adaptive brightness toggle to optimize the brightness level according to the available lighting of your surroundings.

Refresh rate

Change the screen display's refresh rate.

1. From the Desktop, swipe up to show the Applications drawer, then tap Settings > Display.
2. Tap Refresh rate and then select the desired refresh rate from the options.

Night light

Tints the phone screen in amber, making it easier to read in dim light.

1. From the Desktop, swipe up to show the Applications drawer, then tap Settings > Display > Night Light.
2. Change any of the Night Light's properties listed below:
 - o Turn on automatically. Select when the Night Light mode will turn on and off.
 - o Color Profiles. Select which Night Light mode color profile will be used.
 - o Night Light. Toggle Night Light on or off.

Wallpaper

Change the wallpaper of the phone's lock and Desktop.

1. From the Desktop, swipe up to show the Applications drawer, then tap Settings > Display > Wallpaper.
2. Select the preferred app source of the image to be used as wallpaper.
3. Tap Set Wallpaper to use the selected image as your wallpaper.



Sleep

Personalize the amount of time needed for the screen display to turn off.

1. From the Desktop, swipe up to show the Applications drawer, then tap Settings > Display > Sleep.
2. Select the preferred time of inactivity before the screen will turn off.

Screen saver

Customize the screen display when the phone is docked and/or charging.

1. From the Desktop, swipe up to show the Applications drawer, then tap Settings > Display > Screen saver.
2. Toggle the screen saver on to enable the screen saver.
3. Select a screen saver mode:
 - Clock. Display an analog or digital clock. Tap the  icon to select which clock type to be displayed and if Night Light will be used.
 - Colors. Display a spectrum of changing colors.
 - Photo. Display pictures in a photo frame. Tap the  icon to select which image folders will be included.
 - Photo table. Display pictures in a photo table. Tap the  icon to select which image folders will be included.
 - Photos. Display pictures from your device or from your Google account, and customize the effects and network data to be used.

Ambient display

Toggle if the screen will wake when receiving notifications on or off.

1. From the Desktop, swipe up to show the Applications drawer, then tap Settings > Display > Ambient display.
2. Toggle the ambient display on to wake the screen automatically when notifications are received.

Tap to Wake

Toggle if the screen will wake up when double tapping anywhere on the screen.

1. From the Desktop, swipe up to show the Applications drawer, then tap Settings > Display > Tap to Wake.
2. Toggle the Tap to Wake option on.

Font Size, Display Size, & Display Resolution

Make the items and text on the screen smaller or larger.

1. From the Desktop, swipe up to show the Applications drawer, then tap Settings > Display.
2. Tap the screen setting that you want to customize among the three settings.
3. Adjust the slider to increase or decrease the size of text, display size, or screen resolution.

When device is rotated

Set the orientation of the screen when the phone is in portrait or landscape view.

1. From the Desktop, swipe up to show the Applications drawer, then tap Settings > Display > When device is rotated.
2. Select the screen orientation:
 - Rotate the contents of the screen. **Automatically rotates the phone's screen when the phone rotates.**
 - Stay in portrait view. **Retains the phone's orientation** even when the phone is rotated.

Notifications

Individually manage the notifications provided by each app.

Configuring each app's notifications

1. From the Desktop, swipe up to show the Applications drawer, then tap Settings > Notification.
2. Tap the app from the list that you want to configure.
3. Toggle on any of the settings provided for the app:
 - Block all. Hides all notifications from the selected app.
 - Show silently. Shows the notifications on screen without sound and/or vibrations.
 - Override Do Not Disturb. Notifications from the selected application will still work even when the Do Not Disturb function is set to Priority only.

Configuring other notifications

Change the notifications displayed by the LED indicator and lock screen.

1. From the Desktop, swipe up to show the Applications drawer, then tap Settings > Notification.
2. Tap  to toggle any of the following options on or off:
 - Pulse notification light. Toggle the LED indicator for notifications on or off.
 - Low battery light. Toggle the LED indicator for low battery status on or off.
 - On the lock screen. Show or hide app notifications on the lock screen.

Sound

Configure sound profiles, adjust system volumes, and set the ringtones and other sounds for your phone.

Selecting a sound profile

1. From the Desktop, swipe up to show the Applications drawer, then tap Settings > Sound.
2. Tap Profile to select a profile or tap Dolby Atmos Settings to select and/or customize your own profile. [Click here to know more about the Dolby Atmos app](#)

Adjusting system volume and vibration

Use the sliders for Media, Alarm, and Ring volume to individually adjust each setting as preferred. You may also toggle the Also vibrate for calls to enable vibration for phone calls.

Do not disturb

Mute or allow specific notifications and other alerts according to your preferred time or schedule.

Configuring the Priority Only mode

1. From the Desktop, swipe up to show the Applications drawer, then tap Settings > Sound > Do not disturb.
2. Tap Priority only allows.
3. Toggle on the settings which you want the Priority Only mode to allow.
4. Set which contacts are allowed to send you messages or phone calls.

Note: you may also toggle the Repeat callers on to enable your contacts to call you within the 15-minute period.

Customizing automatic rules

Use automatic rules to specify which notifications, alerts, and alarms will take effect during preferred periods.

1. From the Desktop, swipe up to show the Applications drawer, then tap Settings > Sound > Do not disturb.
2. Tap Automatic rules.
3. Select any of the available rule presets and then toggle it on. You may also tap Add rule to create your new rule.
 - Rule name. Specify the rule name.
 - Days. Define the day(s) the rule will apply to.
 - Start and End time. Define the duration of the rule.

- Do not disturb. Specify which Do not disturb mode will apply to the rule.
- Alarm can override end time. Toggle alarms to work beyond the end time.

Blocking visual disturbances

Enable or disable notifications silenced by Do not disturb from peeking or popping onscreen, waking the screen, or using the LED indicator when the screen is off or on.

Changing ringtones

Customize the system ringtones.

1. From the Desktop, swipe up to show the Applications drawer, then tap Settings > Sound.
2. Select your preferred ringtone for any of the following sound settings:
 - Phone ringtone. Changes the default ringtone for phone calls.
 - Default Notification ringtone. Applies a default ringtone for all notifications.
 - Default alarm ringtone. Applies a default ringtone for all alarms.
3. Tap OK to apply.

Emergency broadcast settings

Modify emergency alert settings and ETWS settings.

1. From the Desktop, swipe up to show the Applications drawer, then tap Settings > Sound > Emergency broadcasts.
2. Toggle on any of the Emergency alert settings and Earthquake Tsunami Warning System, settings.
3. Tap Alert reminder and then select the preferred interval between alerts.
4. Tap OK to apply.

Other sounds

Customize other system tones and sounds.

1. From the Desktop, swipe up to show the Applications drawer, then tap Settings > Sound > Other sounds.
2. Toggle any of the sound or vibration settings on or off.

Apps

View, disable, manage, or set default applications installed in your phone.

From the Desktop, swipe up to show the Applications drawer, then tap Settings > Apps. You may then view, change, or use the following options or settings below:

- Uninstall/Disable. Uninstall or disable an app. You may only disable pre-loaded applications.
- Force stop. Stop the operation of the selected app. This is useful when an app is misbehaving and/or if you want to restart the selected app.
- Storage. View and manage the storage consumption of a selected app.
- Data usage. View and manage the data usage of a selected app.
- Notifications. **Manage the behavior of the selected app's notifications.**
- Open by default. Set this app as the default app when supported links are tapped.
- Battery. Displays the battery and CPU usage of the selected app.
- Memory. View the memory usage of the selected app.
- App details. Redirects you to where the app was downloaded. This is not available for pre-loaded applications.
- Draw over other apps. Enable an app to run over other apps.
- Modify system settings. Enable the selected app to modify your phone's **system settings**.

Storage

View and manage the internal and portable storages of your phone.

Managing internal storage

Access and manage the internal storage of your phone.

1. From the Desktop, swipe up to show the Applications drawer, then tap Settings > Storage.
2. Tap Internal shared storage. You may then view and manage the storage consumption by category or explore the internal storage.

Viewing internal storage

Access and manage the portable storage of your phone.

1. From the Desktop, swipe up to show the Applications drawer, then tap Settings > Storage.
2. Tap Portable storage.

Ejecting / Mounting a microSD card

Before removing a microSD card from the phone, it is strongly recommended to eject / unmount it first to avoid corrupting the portable storage.

1. From the Desktop, swipe up to show the Applications drawer, then tap Settings > Storage.
2. Tap the ▲ icon of the Portable storage to eject it.

Note: To mount the storage again, simply tap the detected portable storage, and then tap Mount.

3. Remove the MicroSD card from the SIM card slot.

Battery

Monitor and manage the battery consumption of each application used since the phone has been fully charged.

Enabling battery saver

Battery saver is designed to automatically reduce the performance, background data, and other services when your **phone's battery has reached the selected percentage**.

1. From the Desktop, swipe up to show the Applications drawer, then tap Settings > Battery > Battery saver.
2. Toggle Battery saver on.
3. Tap Turn on automatically and select the preferred battery level percentage for the Battery saver to turn on.

Optimizing apps for battery use

By default, some of the apps you have installed are already optimized for battery use. To change the battery optimization of an application.

1. From the Desktop, swipe up to show the Applications drawer, then tap Settings > Battery > Battery saver.
2. Tap , and then tap Battery optimization.
3. Select an app from the list that you want to have the optimization changed.

Note: You may also tap the All apps dropdown and then select Not optimized to simply see the apps that are not optimized yet.

Memory

Monitor the memory usage of each app.

1. From the Desktop, swipe up to show the Applications drawer, then tap Settings > Memory.
2. Select the preferred hours of history from the dropdown list.

Gestures

Configure additional feature triggers for your phone.

1. From the Desktop, swipe up to show the Applications drawer, then tap Settings > Gestures.
2. Toggle the features below on or off:
 - Jump to Camera. Set the camera to launch upon pressing the power key twice.
 - Lift to check phone. Set your phone to wake and display notifications upon being lifted. Do take note that the phone will only unlock if the lock screen is not enabled.

Game Booster

View and optimize **your battery's** usage by selecting the best battery mode which fits your phone usage or by customizing the resource consumption of each game installed.

Set a game booster mode your phone will use. The battery chart displays how long the battery will last and the amount of performance the selected mode will use.

1. From the Desktop, swipe up to show the Applications drawer, then tap Settings > Game Booster.
2. Tap your preferred mode from the list. Check the changes in the performance and battery duration on the diagram provided.
 - Custom. **Individually configure each game's resource consumption. You may add / remove games / apps in the list and have each configured according to your needs.**
 - Power Save. Maximize the remaining battery level by minimizing performance.
 - Performance. Maximizes overall phone performance.
3. You may also toggle the Do Not Disturb feature to disable notifications while in game.
4. Toggle Share usage and diagnostic data on or off.

Razer Preferences

Enable the phone to share your device and app usage data to Razer to enhance your Android experience.

1. From the Desktop, swipe up to show the Applications drawer, then tap Settings > Razer Preferences.
2. Toggle Share usage and diagnostic data on or off.

Personal

Customize security and account settings.

Location

Set the mode of accuracy for the location services used by your apps.

1. From the Desktop, swipe up to show the Applications drawer, then tap Settings > Location.
2. Tap Mode to select the accuracy mode of the location services
 - High accuracy. Uses GPS, Wi-Fi, Bluetooth or cellular networks to determine location.
 - Battery saving. Use Wi-Fi, Bluetooth or cellular networks to determine location.
 - Device only. Use GPS to determine location.
3. You may also tap  and then tap Scanning to toggle on other features which may improve the location performance further
 - Wi-Fi scanning. Allow system apps and services to detect Wi-Fi networks at any time.
 - Bluetooth scanning. Allow system apps and services to detect Bluetooth devices at any time.

Security

Set the security settings of your phone.

Setting a screen lock

Set a screen lock for your phone.

1. From the Desktop, swipe up to show the Applications drawer, then tap Settings > Security.
2. Tap Screen lock, and then select the preferred screen lock mode:
 - None. Removes the screen lock
 - Swipe. Unlock the screen by swiping.
 - Pattern. Unlock the screen through a pattern you have registered.
 - PIN. Use a PIN to unlock the screen.
 - Password. Use your preferred password to unlock the screen.

To configure other screen lock settings

1. From the Desktop, swipe up to show the Applications drawer, then tap Settings > Security.
2. Tap the settings icon () of the Screen lock menu, and configure any of the following options:
 - Automatically lock. Set the needed time for the screen lock to activate.
 - Power button instantly locks. Allow the power key button to lock your screen.
 - Lock screen message. Set a lock screen message.

Setting a Fingerprint lock

You may also register your fingerprint and use it to unlock your phone, sign in to apps, and other security purposes.

1. From the Desktop, swipe up to show the Applications drawer, then tap Settings > Security.
2. Tap Fingerprint, and then follow the onscreen instructions in registering your fingerprint.

Using the smart lock settings

Once you have set a screen lock for your phone, you may use other phone features to conveniently unlock your phone when needed.

1. From the Desktop, swipe up to show the Applications drawer, then tap Settings > Security > Smart Lock.
2. Enter your device PIN. You may use any of the following smart lock features below:
 - On-body detection. Once unlocked, the phone will stay unlocked when it is in motion and will automatically lock once set down.
 - Trusted places. Uses the home address or location you have set to automatically unlock the phone.
 - Trusted devices. Add devices which will automatically unlock the phone when nearby.
 - Trusted voice. **Use the phone's voice recognition to unlock the device.**

Setting up a SIM card lock

Require a PIN code to use your SIM card.

1. From the Desktop, swipe up to show the Applications drawer, then tap Settings > Security.
2. Tap the settings icon () of the Screen lock menu, and configure any of the following options:

Making passwords visible

Swiftly display the password characters as you type it.

1. From the Desktop, swipe up to show the Applications drawer, then tap Settings > Security.
2. Toggle Make passwords visible on.

Enabling Device Administrators

View or deactivate apps on your phone that have device administrator privileges.

1. From the Desktop, swipe up to show the Applications drawer, then tap Settings > Security.
2. Tap Device Administrators and then tap the check boxes of the apps that you want to activate or deactivate.

Unknown sources

Enable or disable non-Google Play apps from unknown sources to be installed on your phone.

1. From the Desktop, swipe up to show the Applications drawer, then tap Settings > Security.
2. Toggle Unknown sources to on or off.

Credential storage

View and manage credentials and security certificates.

1. From the Desktop, swipe up to show the Applications drawer, then tap Settings > Security.
2. Go to the Credential storage section and modify any of the following.
 - Storage type. Displays where all credentials are stored.
 - Trusted credentials. Displays all trusted certificates.
 - User credentials. View all credentials stored in your device.
 - Install from SD Card. Browse certificates from the microSD card.
 - Clear credentials. Remove all certificates.

Trust agents

View or deactivate trust agents on your phone.

1. From the Desktop, swipe up to show the Applications drawer, then tap Settings > Security.
2. Tap Trust agents, and then toggle on the trust agents that you want on or off.

Screen pinning

Pin a specific app on screen, temporarily blocking access to your other apps.

1. From the Desktop, swipe up to show the Applications drawer, then tap Settings > Security.
2. Toggle Screen pinning on.

Permitting usage access

See which apps monitor and track your app usage.

1. From the Desktop, swipe up to show the Applications drawer, then tap Settings > Security.
2. Tap Apps with usage access, and then tap the apps that you want to permit or deny access.



Accounts

View, sync, or add accounts on any of the accounts you have on your phone.

Adding an account

1. From the Desktop, swipe up to show the Applications drawer, then tap Settings > Accounts.
2. Tap Add account, and then select which app you want to add an account for.
3. Follow the onscreen instructions and enter the required credentials.

Syncing or removing accounts

1. From the Desktop, swipe up to show the Applications drawer, then tap Settings > Accounts.
2. You may tap  to enable Auto-sync data.
3. You may also tap on each app and then tap the  provided to manually sync an account or remove it from your accounts.

Changing account settings

1. From the Desktop, swipe up to show the Applications drawer, then tap Settings > Accounts.
2. Tap that app account that you want to modify, and then change its settings as needed.

Note: App settings availability may vary for each app.

Languages & input

Modify the language used and input settings of your phone.



Adding / reorganizing language preferences

Add preferred languages and reorganize language priority as needed. Language priority enables an app to determine which language will be used next if the language you are currently using is not supported by the app.

1. From the Desktop, swipe up to show the Applications drawer, then tap Settings > Languages & input.
2. Tap Add a language, and then select the preferred language to be added on the list.
3. You may then reorganize the priority of the languages on the list by tapping and dragging the sidebar button () of the corresponding language.

Removing languages

Manage which language and what default spell checker will be used by the phone.

1. From the Desktop, swipe up to show the Applications drawer, then tap Settings > Languages & input.
2. Tap  , and then tap Remove.
3. Tap the languages that you want to remove, and then tap the  button.

Using the Personal Dictionary

Add words you commonly use to make your typing experience more efficient.

1. From the Desktop, swipe up to show the Applications drawer, then tap Settings > Languages & input.
2. Tap Personal dictionary, and then tap + ADD or tap the word that you want to change or delete.
3. Type in the word that you want to add on the list, and then enter the preferred shortcut. You may also simply tap the DELETE button to remove the entry from the list.

Using the spell checker

Manage which language and what default spell checker will be used by the phone.

1. From the Desktop, swipe up to show the Applications drawer, then tap Settings > Languages & input.

2. Tap Spell checker, and then tap languages to select the language it will use.
3. Tap the Default spell checker to select which spell checker it will use. You may also tap the settings button () to include contact names on its list.

Customizing physical keyboards

Customize physical keyboard connected to your phone.

1. From the Desktop, swipe up to show the Applications drawer, then tap Settings > Languages & input.
2. Tap Physical keyboard. You may then change any of the following settings:
 - Show virtual keyboard. Display the virtual keyboard even when the physical keyboard is active.
 - Keyboard shortcuts helper. Display the available keyboard shortcuts on screen.

Customizing virtual keyboards

Customize the virtual keyboards enabled on your phone.

1. From the Desktop, swipe up to show the Applications drawer, then tap Settings > Languages & input.
2. Tap Virtual keyboard and then tap the virtual keyboard that you want to customize.
Note: You may also tap Manage keyboards to enable or disable active virtual keyboards.

Text-To-Speech output

Manage the Text-to-Speech (TTS) output settings.

1. From the Desktop, swipe up to show the Applications drawer, then tap Settings > Languages & input.
2. Tap Text-to-speech output and then modify any of the following options:
 - Preferred engine. Select your preferred TTS engine on the list. You may tap the settings icon () to change the language, Google TTS engine settings, or install voice data.
 - Speech rate. Adjust the speed at which the text is spoken.
 - Pitch. Adjust the pitch at which the text is spoken.
 - Reset speech rate. Reset the speed at which the text is spoken.

- Reset speech pitch. Reset the pitch at which the text is spoken.
- Listen to an example. Play a short demonstration of speech synthesis.
- Default language status. Displays the default language.

Adjusting the pointer speed

Adjust the mouse pointer speed of a connected mouse.

1. From the Desktop, swipe up to show the Applications drawer, then tap Settings > Languages & input.
2. Tap Pointer speed and then adjust the pointer speed using the slider as needed.

Backup & Reset

Configure backup and reset settings for your phone.

Enabling automatic data backup

Periodically save device and app data remotely. App data can be any data that an app has saved (based on developer settings) including potentially sensitive data such as contacts, messages and photos.

1. From the Desktop, swipe up to show the Applications drawer, then tap Settings > Backup & Reset.
2. Toggle Back up my data on.

Enabling automatic restore

Restore backed up settings and data when reinstalling an app.

1. From the Desktop, swipe up to show the Applications drawer, then tap Settings > Backup & Reset.
2. Toggle Automatic restore on.

Setting a backup account

Choose or add a Google account as your backup account.

1. From the Desktop, swipe up to show the Applications drawer, then tap Settings > Backup & Reset.
2. Tap Backup account and then select the Google account that you want to use, or tap + Add account to set up a new account.

Performing a factory data reset

Erase all data from your phone's internal storage. This includes your Google account, system and app data, downloaded apps, music, photos, and other user data.

1. From the Desktop, swipe up to show the Applications drawer, then tap Settings > Backup & Reset.
2. Tap RESET PHONE.

Date & Time

Configure the date and time settings of your phone. By default, these are automatically updated through data service or an active wireless connection.

1. From the Desktop, swipe up to show the Applications drawer, then tap Settings > Date & Time. You may then change any of the following settings:
 - Automatic date & time. Use network provided time.
 - Automatic time zone. Use network provided time zone.
 - Set date. Manually set the date.
 - Set time. Manually set the time.
 - Select time zone. Manually select a time zone.
 - Use 24-hour format. Toggle between 12-hour and 24-hour time format.

Accessibility

Modify the accessibility features of your phone designed for physical disabilities. From the Desktop, swipe up to show the Applications drawer, then tap Settings > Accessibility. You may then change any of the following settings:

- TalkBack. Provides spoken feedback to help visually impaired users such as describing what you touch, select, and activate. [Click here to learn more about TalkBack](#)
- Select to speak. Enable spoken feedback when tapping items. [Click here to learn more about Select to speak](#)
- Switch access. Enable Switch Access. [Click here to learn more about Switch Access](#)
- Nova launcher. Enable Nova launcher to toggle recent apps or expand notification shade.
- Captions. [Click here to learn more about Captions](#)
- Magnification gestures. Enable screen magnification option gestures on your phone. [Click here to learn more about Magnification](#)
- Font size. Make the screen text larger or smaller.
- Display size. Make the items on your screen smaller or larger.
- Click after cursor stops moving. **Enable a connected portable mouse's pointer to click after being idle for the set amount of time.**
- High-contrast text. Make text more visible and easier to read.
- Power button ends call. [Click here to learn more about Power button ends call](#)
- Auto-rotate screen. [Click here to learn more about Auto-rotate screen](#)
- Speak passwords. [Click here to learn more about Speak passwords](#)
- Large mouse cursor. Make the mouse pointer bigger when a portable mouse (not included) is connected.
- Mono audio. Combine channels when playing audio.
- Accessibility shortcut. Enable options for quickly activate accessibility features. [Click here to learn more about Accessibility shortcut](#)
- Text-to-speech output. Set the properties of the Text-to-speech output. [Click here to learn more about Text-to-speech output](#)
- Touch & hold delay. Define how fast or short the delay should be before your touch is identified as a press and hold. [Click here to learn more about Touch & hold delay](#)
- Colour inversion. Invert the color values used by the screen. [Click here to learn more about Colour inversion](#)
- Colour correction. Adjust screen color for color blindness. [Click here to learn more about Colour correction](#)

8. SAFETY AND MAINTENANCE

SAFETY GUIDELINES

In order to achieve maximum safety while using your Razer Phone, we suggest that you adopt the following guidelines:

- Should you have trouble using the Razer Phone properly and troubleshooting does not work, unplug the phone and contact the Razer hotline or go to support.razer.com for support. Do not attempt to service or fix the phone yourself at any time.
- It is strongly recommended not to use your phone when operating or driving any kind of vehicle. Observe and obey traffic laws, restrictions, and regulations within your area.
- Refrain from using your phone when engaging in any kind of activity that requires active awareness of your surroundings such as walking or jogging.
- Always keep the Razer Phone and its accessories dry. Make sure that your hands are dry whenever using your phone and/or its accessories.
- Do not use your phone and/or any of the included accessories near water, moisture, solvents or other wet surfaces. In addition, do not expose the phone to extremely high temperatures or direct sunlight for extended periods of time.
- **When using any of your phone's accessories, always organize its cables for safety.**
- Keep the Razer Phone and its accessories away from children.
- **Only use the SIM eject pin to the allotted hole of your phone's SIM tray.**
- Turn off your phone in areas that fully prohibit its usage such as (but not limited to) aircrafts, gasoline stations, or theaters.
- **The Razer Phone's screen is designed to quickly respond to light taps and button presses.** Do not excessively tap the screen nor press any of its buttons with undue pressure or force.
- **Should your Razer Phone's screen get broken or cracked, stop using** the phone and immediately bring it to a qualified servicing personnel for repair.
- **The Razer Phone's power key also works as a fingerprint sensor. Do not expose** its power key to objects which may cause dents or scratches on its outer surface such as coins and/or keys.
- Always handle your Razer phone with care. Do not drop nor expose your phone to undue pressure and excessive shaking.
- Only use the Quick charger and/or accessories included in the package, and/or purchase accessories made and/or approved by the manufacturer.

- Do not take apart the phone (doing so will void your warranty) and do not attempt to operate it under abnormal current loads.
- Downloading/uploading files, audio or video streaming, enabling your phone's GPS or location and other similar data services, may incur data charges. Please turn off your mobile data if you are not using any data service.
- Operate the Razer Phone only within the specific temperature range of 0°C (32°F) to 40°C (104°F). Should the temperature exceed this range, unplug and/or switch off the phone in order to let the temperature stabilize to an optimal level.

BATTERY WARNING

The Razer Phone contains an internal, lithium-ion polymer rechargeable battery. In general, the life expectancy of this battery depends upon its usage. If the battery does not charge after several attempts, it may be non-operational and you may need to contact customer support. Do not attempt to replace the battery yourself.

Do not open, mutilate, or expose to conducting materials (metal), moisture, liquid, fire, or heat. Doing so may cause the battery to leak or explode, resulting in personal injury. Do not use or charge the battery if it is leaking, discolored, or deformed.

Do not leave the battery discharged or unused for extended periods. When not using your Razer Phone for more than 30 days, be sure to store the battery in a fully charged state. This will prevent damage to the battery due to an overly discharged state.

9. LEGALESE

COPYRIGHT AND INTELLECTUAL PROPERTY INFORMATION

©2018 Razer Inc. All rights reserved. Razer, the triple-headed snake logo, Razer logo, "For Gamers. By Gamers.", "Powered by Razer Chroma" logo and Razer Phone are trademarks or registered trademarks of Razer Inc. and/or affiliated companies in the United States or other countries. All other trademarks and trade names are the property of their respective owners and other company and product names mentioned herein may be trademarks of their respective companies.

Dolby and Dolby Atmos are trademarks of Dolby Laboratories.

© 2017 Google Inc. All rights reserved. Android, Google Play, Google Voice Search, Google Chrome, Gmail are trademarks of Google Inc.

The Bluetooth® word mark and logos are registered trademarks owned by the Bluetooth SIG, Inc. and any use of such marks by Razer is under license. All other trademarks and trade names are the property of their respective owners and other company and product names mentioned herein may be trademarks of their respective companies.

Razer Inc. ("Razer") may have copyright, trademarks, trade secrets, patents, patent applications, or other intellectual property rights (whether registered or unregistered) concerning the product in this guide. Furnishing of this guide does not give you a license to any such copyright, trademark, patent or other intellectual property right. The Razer Phone (the "Product") may differ from pictures whether on packaging or otherwise. Razer assumes no responsibility for such differences or for any errors that may appear. Information contained herein is subject to change without notice.

LIMITED PRODUCT WARRANTY

For the latest and current terms of the Limited Product Warranty, please visit [razer.com/warranty](https://www.razer.com/warranty)

LIMITATION OF LIABILITY

Razer shall in no event be liable for any lost profits, loss of information or data, special, incidental, indirect, punitive or consequential or incidental damages, arising in any way out of distribution of, **sale of, resale of, use of, or inability to use the Product. In no event shall Razer's liability exceed the retail purchase price of the Product.**

COSTS OF PROCUREMENT

For the avoidance of doubt, in no event will Razer be liable for any costs of procurement unless it has been advised of the possibility of such damages, and in no case shall Razer be liable for any costs of procurement liability exceeding the retail purchase price of the Product.

GENERAL

These terms shall be governed by and construed under the laws of the jurisdiction in which the Product was purchased. If any term herein is held to be invalid or unenforceable, then such term (in so far as it is invalid or unenforceable) shall be given no effect and deemed to be excluded without invalidating any of the remaining terms. Razer reserves the right to amend any term at any time without notice.