



# RAZER KISHI V2 USB C

MASTER GUIDE

Rethink everything you knew about mobile gaming. **Razer Kishi V2 USB C** is a universal mobile gaming controller that brings a console-class gameplay experience to your smartphone. Play the best AAA games, on your mobile phone, exactly as you'd expect to play them on a game console – zero compromises.

# CONTENTS

1. WHAT'S INSIDE.....	3
2. WHAT'S NEEDED .....	4
3. LET'S GET YOU COVERED .....	4
4. GETTING STARTED.....	5
5. USING THE CONTROLLER .....	7
6. SAFETY AND MAINTENANCE .....	9
7. LEGALESE.....	10

---

## 1. WHAT'S INSIDE

- Razer Kishi V2 USB C

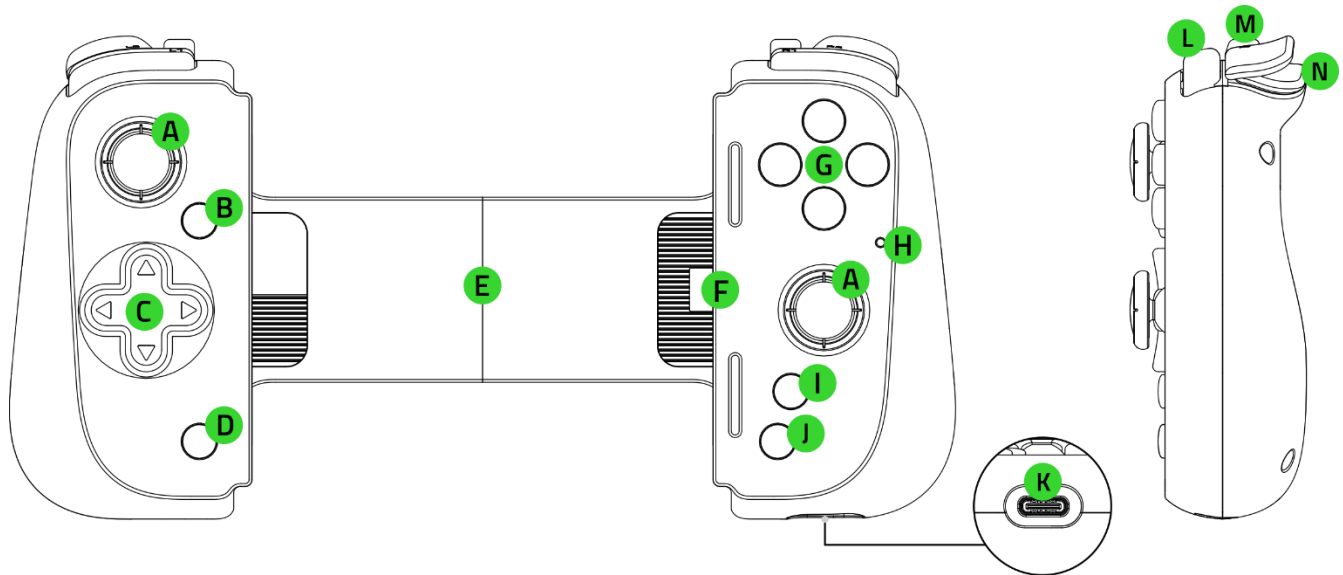

- A. Clickable analog thumbsticks (L3 / R3)
- B. Options button
- C. D-pad
- D. Share button
- E. Extendable bridge
- F. USB Type C connector
- G. Face buttons
- H. Status indicator
- I. Razer Nexus button
- J. Menu button
- K. USB Type C port\*
- L. Bumpers (L1 / R1)
- M. Multi-function buttons (L4 / R4)
- N. Triggers (L2 / R2)

*\*Only supports PC connection and passthrough charging. USB Type C audio and other accessories are not supported.*

- 2 pairs of interchangeable rubber cushions  
*(A pair of rubber cushions are pre-installed with the controller)*
- Important Product Information Guide

---

## 2. WHAT'S NEEDED

- Mobile device or PC with a USB Type A / Type C port
  - iOS 17 / Android™ 12 or higher<sup>†</sup>
  - Windows® 11 64-bit<sup>††</sup>
- Internet connection for app installation

<sup>†</sup>Compatible with iPhone 15 Pro, iPhone 15 Plus, iPhone 15, Samsung Galaxy S23 Series, and Google Pixel 6 / 7 / 8.

<sup>††</sup>External cable required, sold separately.

---

## 3. LET'S GET YOU COVERED



Register your product and score exclusive benefits

[razerid.razer.com/warranty](https://razerid.razer.com/warranty)

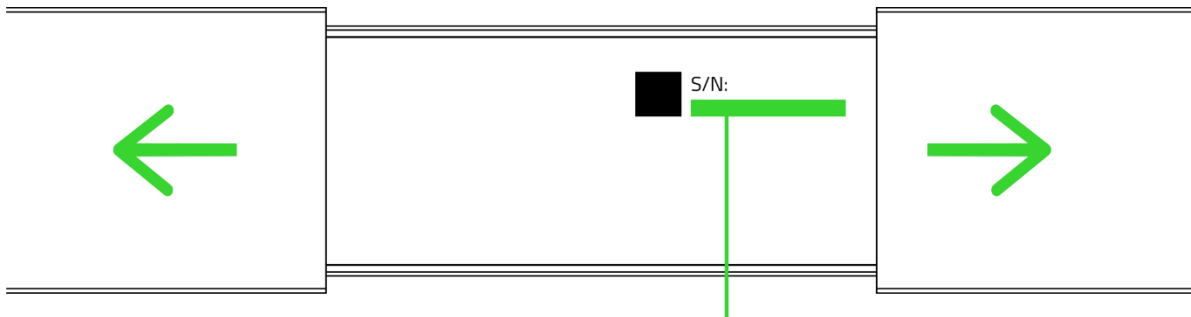

*Your product's serial number can be found here.*

---

## 4. GETTING STARTED

### SETTING IT UP

#### A. With your mobile device

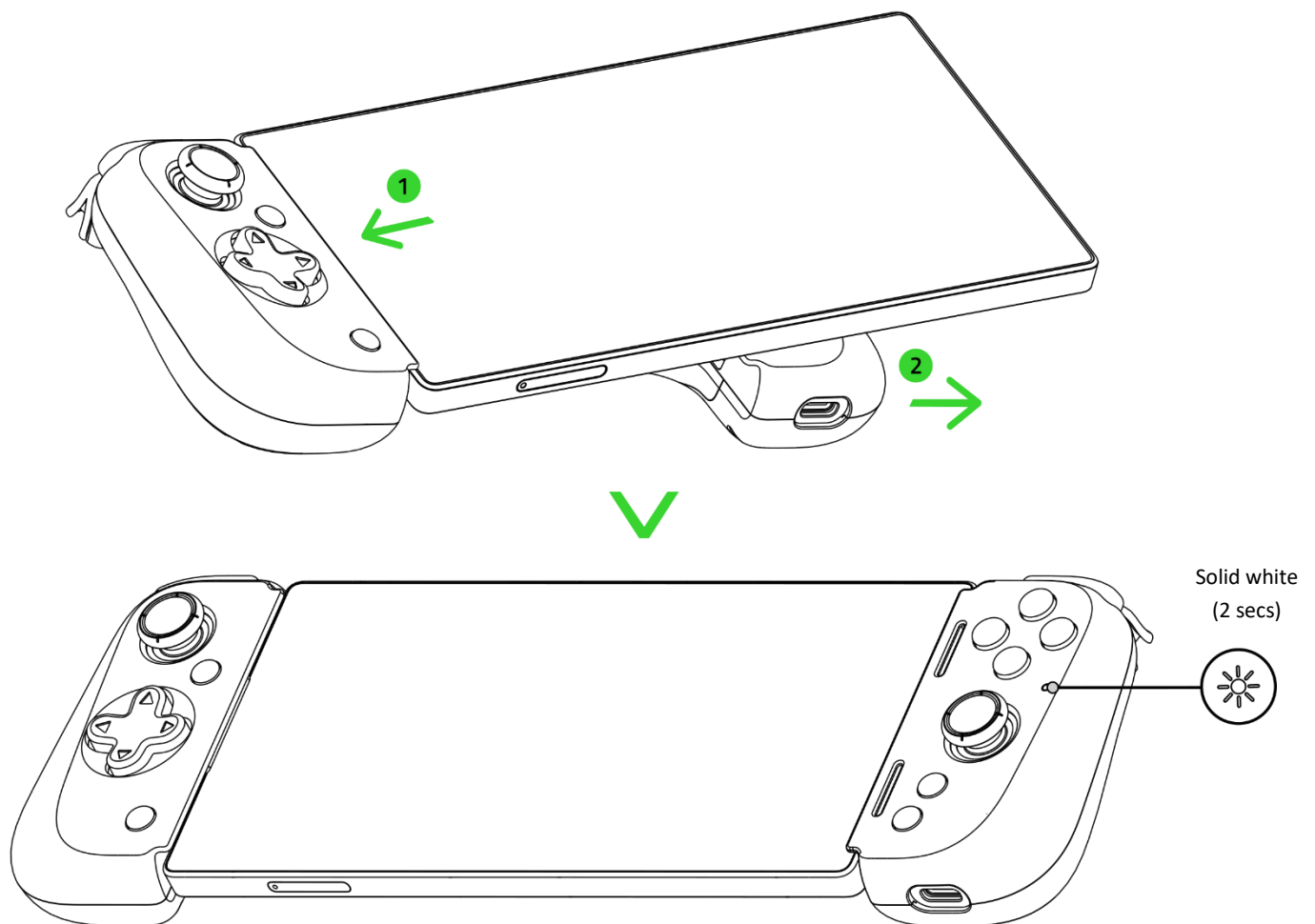

**i** Maximum supported dimensions: 11.5 mm (thickness, including camera) x 170 mm (Length)

## B. With your PC

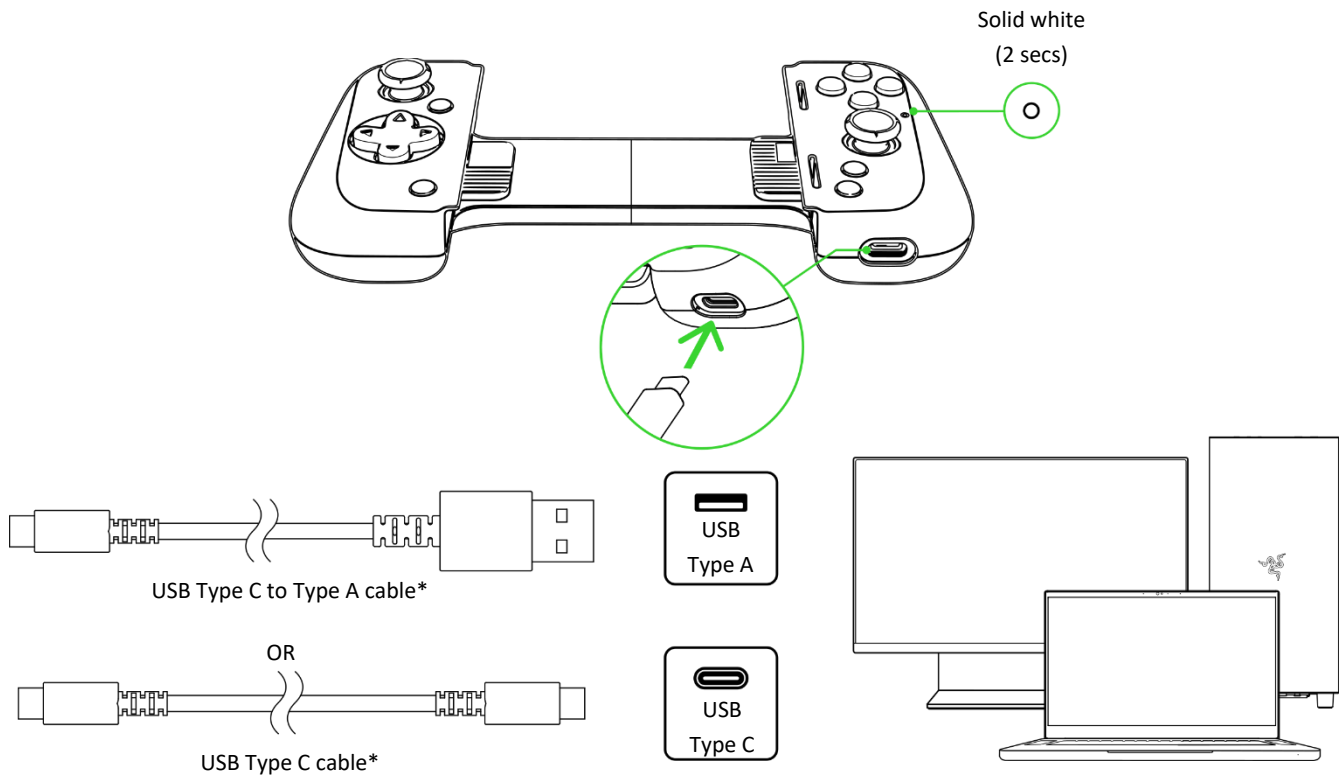

*\*not included, sold separately.*

**i** Detach your mobile device when using the controller on a PC. The controller will use XInput on Windows.

## INSTALL THE RAZER NEXUS GAME LAUNCHER (FOR MOBILE DEVICES)

Launch compatible titles, remap controller buttons, take screenshots, record and share your gameplay, and much more – anytime and anywhere.



RZR.TO/NEXUS-APP



Razer Nexus  
Game Launcher

---

## 5. USING THE CONTROLLER

### DETACHING YOUR PHONE

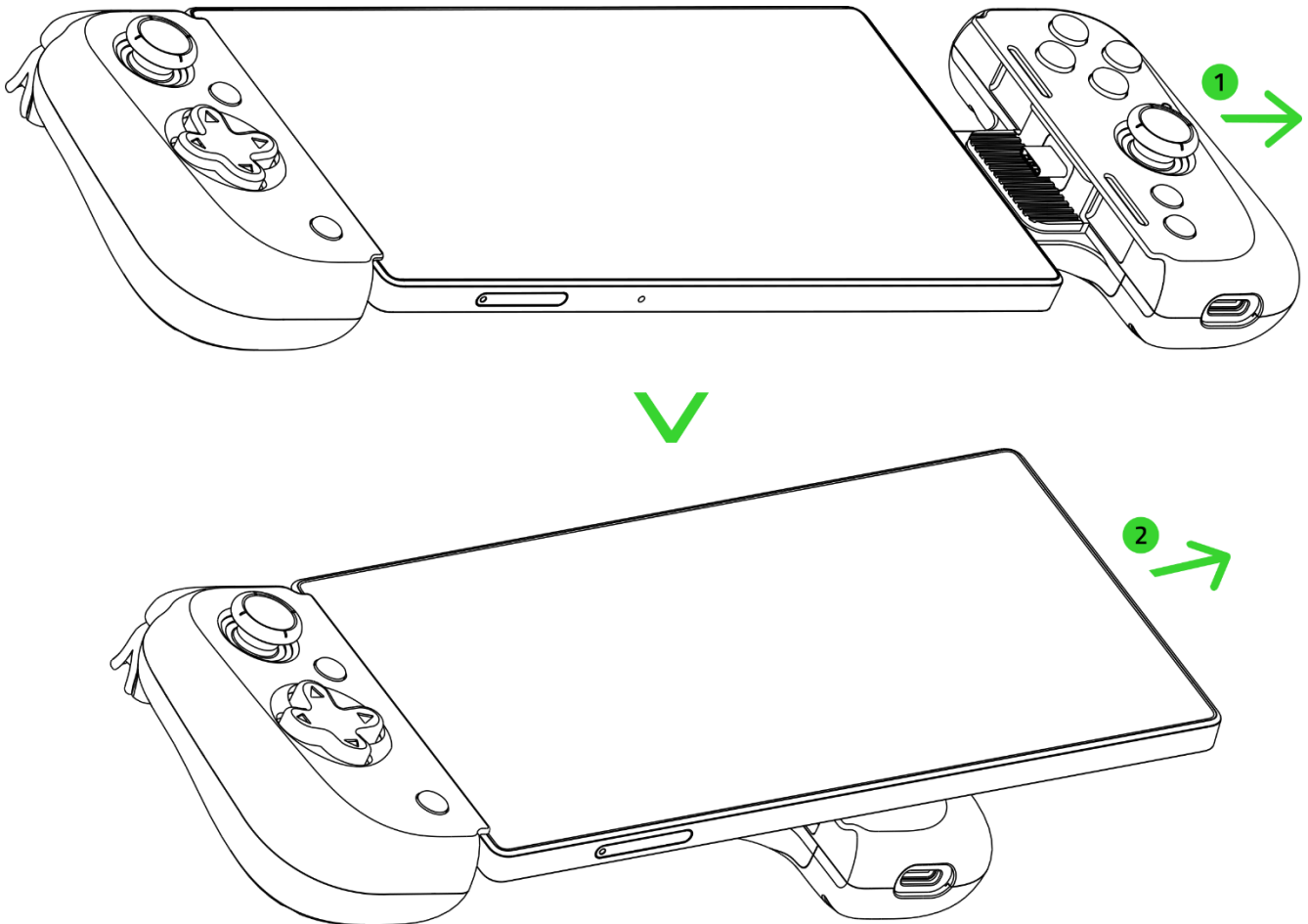

## PASSTHROUGH CHARGING

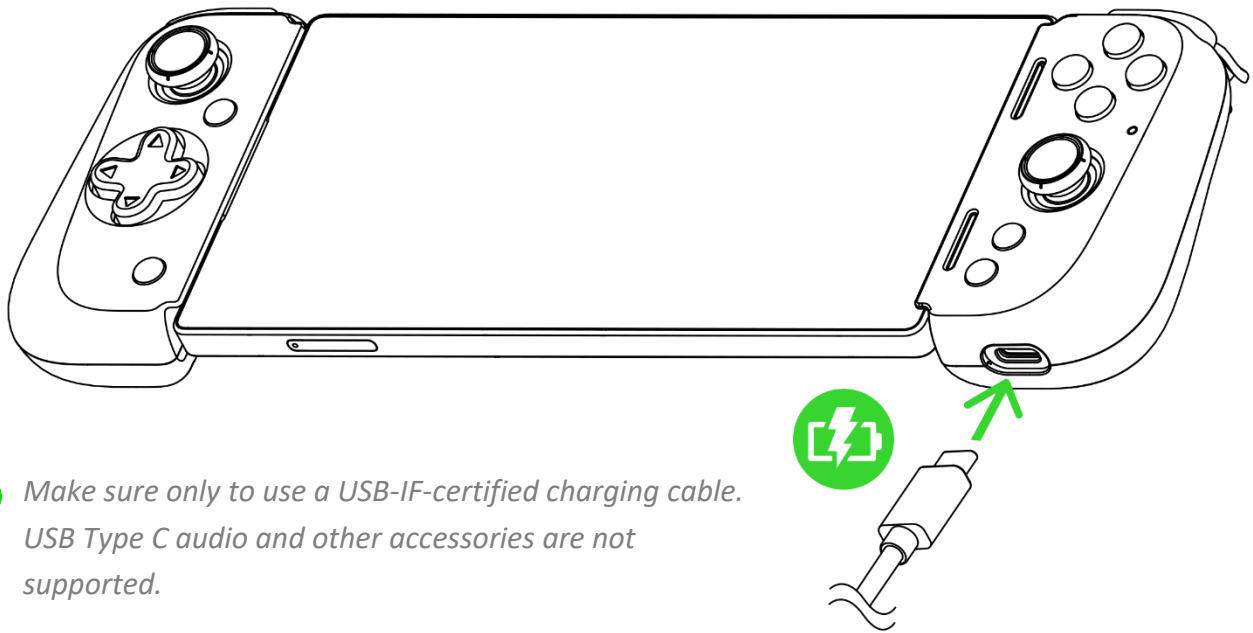

- i** *Make sure only to use a USB-IF-certified charging cable. USB Type C audio and other accessories are not supported.*

## CHANGING THE RUBBER CUSHIONS

Switch between the pre-installed rubber cushions and the extra pair in the package to ensure your phone fits snugly in the controller.

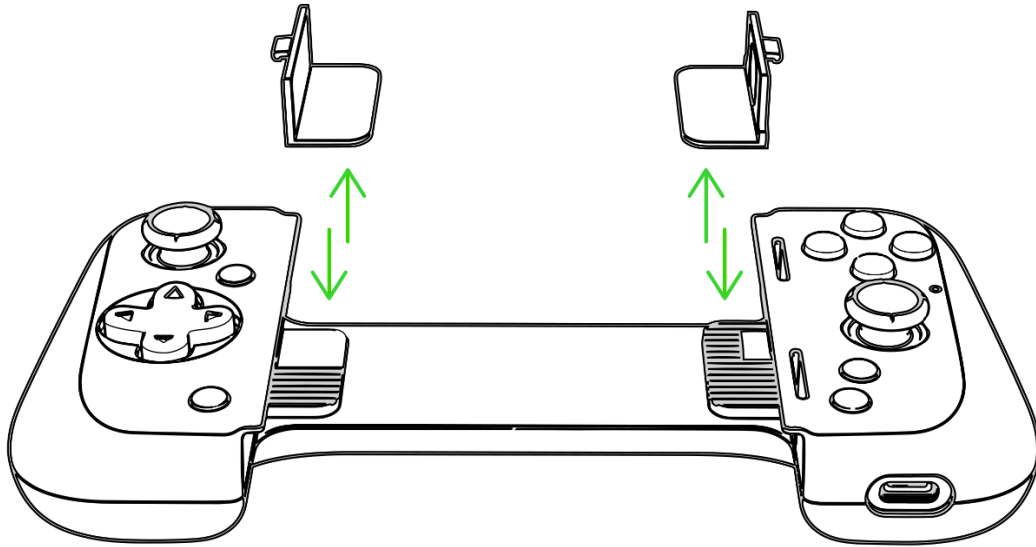

*For a case-fitted mobile device, you can also try removing the rubber cushions to see if it's compatible with the controller.*

---

## 6. SAFETY AND MAINTENANCE

### SAFETY GUIDELINES

To achieve maximum safety while using your Razer Kishi V2 USB C, we suggest that you adopt the following guidelines:

Should you have trouble operating the device properly and troubleshooting does not work, make sure to unplug the device (if applicable) and contact the Razer hotline or go to [support.razer.com](https://support.razer.com) for support.

Don't take apart the device, and don't attempt to operate it under abnormal current loads. Doing so will void your warranty.

Keep the controller's accessories out of the reach of small children to avoid accidents and/or injuries.

Keep the device away from liquid, humidity, or moisture. Operate the device only within the specific temperature range of 0°C (32°F) to 40°C (104°F). Should the temperature exceed this range, detach the device to let its temperature stabilize to an optimal level.

## MAINTENANCE AND USE

The Razer Kishi V2 USB C requires minimum maintenance to keep it in optimum condition. Once a month, we recommend you clean the device using a soft cloth or cotton swab to prevent dirt buildup.

---

## 7. LEGALESE

### COPYRIGHT AND INTELLECTUAL PROPERTY INFORMATION

©2024 Razer Inc. All rights reserved. Razer, the triple-headed snake logo, Razer logo, “For Gamers. By Gamers.”, and “Razer Chroma” logo are trademarks or registered trademarks of Razer Inc. or affiliated companies in the United States and other countries. All other trademarks are the property of their respective owners.

Android, Google, Google Logo, Google Play, and the Google Play logo are registered trademarks of Google LLC.

Apple, Apple TV, Apple Watch, iPad, iPad Air, iPad Pro, iPhone, and Lightning are trademarks of Apple Inc., registered in the U.S. and other countries.

Windows and the Windows logo are trademarks or registered trademarks of the Microsoft group of companies.

Razer Inc. (“Razer”) may have copyright, trademarks, trade secrets, patents, patent applications, or other intellectual property rights (whether registered or unregistered) concerning the product in this guide. Furnishing of this guide does not give you a license to any such copyright, trademark, patent or other intellectual property right. The Razer Kishi V2 USB C (the “Product”) may differ from pictures

whether on packaging or otherwise. Razer assumes no responsibility for such differences or for any errors that may appear. Information contained herein is subject to change without notice.

## LIMITED PRODUCT WARRANTY

For the latest and current terms of the Limited Product Warranty, please visit [razer.com/warranty](https://www.razer.com/warranty).

## LIMITATION OF LIABILITY

Razer shall in no event be liable for any lost profits, loss of information or data, special, incidental, indirect, punitive or consequential or incidental damages, arising in any way out of distribution of, sale of, resale of, use of, or inability to use the Product. In no event shall Razer's liability exceed the retail purchase price of the Product.

## GENERAL

These terms shall be governed by and construed under the laws of the jurisdiction in which the Product was purchased. If any term herein is held to be invalid or unenforceable, then such term (in so far as it is invalid or unenforceable) shall be given no effect and deemed to be excluded without invalidating any of the remaining terms. Razer reserves the right to amend any term at any time without notice.